

BOREHOLES IN BRÆDSTRUP



Final report, June 2013

The project is supported by

ForskEL (project no. 2010 – 1 – 10498)

EUDP (project no. 64012-0007-1)

Project participants

PlanEnergi (Project manager)

Jyllandsgade 1
9520 Skørping
Contact: Per Alex Sørensen
pas@planenergi.dk

Brædstrup Totalenergianlæg A/S

Fjernvarmevej 2
8740 Brædstrup
Contact: Jim Larsen
jim@braedstrup-fjernvarme.dk

Via University College

Chr. M. Østergaardsvej 4
8700 Horsens
Contact: Lotte Thøgersen
lot@viauc.dk

GEO

Sødalsparken 12
8220 Brabrand
Contact: Jan Dannemand Andersen
jda@geo.dk

Per Aarsleff A/S

Lokesvej 15
8230 Åbyhøj
Contact: Claus Østergaard
clo@arsleff.com

SOLITES

Meitnerstrasse 8
70563 Stuttgart
Germany
Contact: Thomas Schmidt
schmidt@solites.de

Content

1	Project progress and summary	5
2	Geotechnical examinations	8
2.1	Site investigations	8
2.2	Test of grouting material	12
3	Design of the pilot plant	14
3.1	Full scale RE system	14
3.2	Design of the borehole heat exchanger	14
3.3	The borehole storage	14
3.4	The energy system	15
3.5	The cost function	16
3.6	GenOpt optimisation	18
3.7	The pilot plant. Initial design	21
3.8	Full scale REsystem. Optimized TRNSYSmodel	21
3.9	Design of the borehole storage	22
3.9.1	Design of boreholes	23
3.9.2	Design of piping	24
3.9.3	Design of the lid	26
4	Tendering	34
4.1	The solar plant and the buffer tank (main supplier)	34
4.2	Drilling of boreholes	34
4.3	Heat pump	34
4.4	Control system	35
4.5	Ground work and punctual foundation for solar collectors	35
4.6	Pipes, valves etc. at the secondary side of the heat exchanger	35
4.7	Pipe and lid construction in the borehole storage	35
5	Authorities permissions	36
6	Implementation	37
6.1	The boreholes	37
6.2	The lid construction	39
6.3	The buffer tank	42
6.4	The solar plant	44
6.5	The heat pump	45
6.6	Piping of the secondary side of heat exchangers	46
6.7	The control system	48
7	Measuring programme	49
7.1	Measuring programme	49
7.1.1	Aims of Measurements and Evaluation	49
7.1.2	Definition of the measuring programme	49
7.1.3	Sensors for system energy balance	49
7.1.4	Additional sensors for seasonal storage evaluation	50
7.1.5	Additional sensors for operation control of the solar collector field	52
7.1.6	Sensor types	53

7.1.7	Recording of data	54
7.1.8	Evaluation programme	55
7.1.9	Evaluations on system level	55
7.1.10	Evaluations on component level	55
7.1.11	Optimisation of control strategy	56
7.2	Monitoring results	56
7.2.1	System heat balance	56
7.2.2	The borehole thermal energy storage	57
7.2.3	Solar collector fields	63
7.2.4	Heat pump	64
8	Control strategy	66
8.1	The overall control strategy	66
8.2	The Danish electricity market	69
9	Economy	71
10	Dissemination	73

Annexes:

1. Map of the full scale plant (Danish text)
2. Map of step 2 (the present project, Danish text)
3. GEO project no. 32926, report 2, 2010-06-22
4. Calculated flows (in Danish)
5. Map where to place the solar collectors (Danish text)
6. Principle diagram
7. Evaluation of heat pump (in Danish)
8. Posters in the pavillon
9. English version of diagram

1 Project progress and summary

Step one

Brædstrup Totalenergianlæg (Brædstrup Total Energy Plant) is the production plant for Brædstrup District heating. The production plant is a natural gas fired CHP unit consisting of 2 gas fired motors, 2 gas boilers and a 2000 m³ steel tank. In 2007 an 8,000 m² solar thermal plant was added. It was the first full scale example of combining solar thermal and natural gas fired CHP. The yearly heat production for Brædstrup Totalenergianlæg is app. 40,000 MWh.

Step two

Implementation of the 8,000 m² solar thermal plant was first step against a gradually change to 100 % renewable energy. The next step is the present project, where an extension of the solar plant to 18,600 m², 5,000 m³ buffer tank, 19,000 m³ pilot borehole storage, 1,2 MW_{heat} heat pump and 10 MW electric boiler has been added.

Step three

A third step extending the solar collector area to 50,000 m², the borehole storage to 200,000 m³ and the heat pump capacity to 3.6 MW_{heat} is already planned. That will bring the fraction of the heat production covered by solar and heat pumps to app. 50 % and the plant will then be able to produce electricity when needed in the market and to consume electricity when needed. Thus this kind of plant will introduce integration of fluctuating electricity production (stored as heat) in a very flexible way.

Application for support and implementation of step two

During the summer 2009 the board of directors in Brædstrup Totalenergianlæg decided to take the above mentioned step two on their way to 100 % RES. Applications were sent to Energinet.dk's support program ForskEI for support to design and implementation of step two and for support to a parallel project financed by Region Midtjylland (Region Mid Jutland) showing the potential of solutions with solar/heatpumps/storages in the district heating systems in the region.

Both applications were supported. The application to Region Midtjylland resulted in the project report "Naturgassens afløser"¹ managed by Brædstrup Totalenergianlæg and the application to ForskEI (the present project) has been managed by PlanEnergi.

During the project period the project group has utilized experiences from a similar borehole project in the German city Crailsheim. The plant in Crailsheim was visited in Winter 2010 and after that the project group used half a day with the German company SOLITES, who had been consultants for Crailsheim and discussed overall design and design of details in a borehole storage. Also SOLITES gave the project group access to design calculations carried out in TRNSYS and to software modules for TRNSYS calculations of boreholes.

¹ Naturgassens afløser. Slutrapport marts 2011.
Projektleder: Brædstrup Totalenergianlæg

CPT-soundings, test boring and thermal response test was carried out in Spring 2010. These tests and laboratory tests made GEO to conclude that

The performed site investigation has shown that the area is suitable for a borehole energy storage, primarily caused by the fact that no horizontal groundwater flow may be expected down to (at least) 50 meters depth.

The soil consists of clay till, which is a relatively well suited for energy storage. The encountered layers of dry sand are though less suited.

The upper 2-3 meters of soil are relatively soft, but the layers below are generally stiff/dense and very stiff/very dense. These conditions shall be taken into account in the planning of drilling method and choice of equipment for the energy boreholes.

A TRNSYS model of the full scale system was set up in June 2010 by PlanEnergi supported by SOLITES. Parameters for soil came from the geological site investigations and cost estimates from the partners in the project.

The result of the design was an optimized full scale project (step 3) and pilot project (step 2). The pilot project showed lower heat production prices than the existing plant (reference) and therefore the board of directors in Brædstrup Totalenergianlæg decided to continue with implementation of the project.

Since this kind of project was new, Brædstrup Totalenergianlæg wanted to include entrepreneurs early in the project to further detail the project in a partnering process. Therefore the main contractor (responsible for implementation of solar panels, piping, accumulation tank, heat exchangers, pumps and valves) was chosen in September 2010 and contractors for control system, drilling of boreholes, supply of heat pump and ground work was also selected in Autumn 2010, so that the implementation team was ready in November 2010. During Winter 2010-2011 detailed design of piping, valves, control system etc. took place in a partnering process, so that the project were technically ready for implementation in March 2011.

In parallel with detailed design, applications for authorities permissions were carried out. For the environmental permission it was necessary to make calculations of the temperatures around the borehole storage to prove that ground water temperatures would not exceed 20° C. For that purpose SOLITES made a special TRNSYS version and PlanEnergi carried out the calculations for GEO who was responsible for the application for environmental permission. Horsens Municipality made a special "Task Force" for the project because permissions had to be given by different parts of the administration, and thanks by that all the needed permissions were ready in March 2011.

In Spring 2011 Horsens Museum therefore started to investigate the building site. They found an ancient settlement in the centre of what was meant to be Brædstrup Solpark. It showed up to be a Medieval settlement, and not so valuable, but it delayed the project start until mid May.

The implementation process lasted one year to May 2012. Several complications turned up during the process. Soil had to be removed before implementation of the accumulation tank, pipes and valves for connection to the existing plant was more expensive than expected, all punctual foundations for the solar collectors had to be replaced by new and the control system was much more expensive than expected. Therefore an additional application for support was sent to ForskEl and

also EUDP. Additional support was given. Finally in the end of May 2012 the Danish Energy Minister could open the new energy plant.

During Summer and Autumn 2012 the employees at Brædstrup Totalenergianlæg learned how to run the new plant, and the first measuring results show that the production results seem to be as expected.

During the whole design and implementation process the information about the project has been disseminated during articles in technical issues, presentations, articles in newspapers and television transmissions.

Also Brædstrup Totalenergianlæg had a lot of visitors during the project. Especially international interest was shown during end of May 2012 by meetings in SDH Plus² and IEA Task 45 (Solar district heating and cooling) and a common workshop between the two projects in Brædstrup. Also a special information brochure in Danish and English was made when implementation was finished.³

During design and implementation there has been an excellent co operation between the entrepreneurs in the project and the employees at Brædstrup Totalenergianlæg.

This has resulted in a unique energy plant, where the future measuring results hopefully will show a continuation of the preliminary good measuring results.

² www.solar-district-heating.eu

³ www.e-pages.dk/nordad/1810/

2 Geotechnical examinations

2.1 Site investigations

GEO has performed a geological and geotechnical site investigation for the BTES project (Borehole Thermal Energy Storage). The extent and results of the site investigation is described in the following. The investigation report is attached in full in Annex 3, GEO project no. 32926, report 2, dated 2010-06-22.

Soundings and borings

The site investigation has initially included CPT-soundings (Cone Penetration Tests) in eight positions, hereof were five CPTs placed in a considered area for the BTES east of the existing solar heat plant and three CPTs were placed around the solar heat plant. The CPTs was penetrated unto maximum possible depth of 9.3 to 20.6 meters (90 kN thrust).

Partly based on these results the considered location for the BTES was decisively chosen. The site was further investigated by two borings:

Boring “no. 3” was carried out as Ø6” cased boring (dry rotary drilling) unto 25 meters depth. Soil layers were registered and soil samples extracted for geological description in GEOs laboratory. During drilling field vane shear tests were carried out in the deeper cohesive layers. Upon completion three 25 mm PVC-standpipes were installed in respectively 7.5, 19 and 25 meters depth. The bore hole was filled with quartz sand except for zones of swelling bentonite pellets between standpipes and near ground level.

Boring “no. 4” was carried out as Ø10” cased boring (dry rotary drilling) unto 51 meters depth, where groundwater was encountered. Soil layers were registered and samples extracted for geological examination. During drilling a few field vane shear tests and SPTs (Standard Penetration Tests) were carried out. At the bottom of the bore hole a Ø63 mm PEH-standpipe was installed, supplemented by a Ø25 mm PVC-standpipe at 7.5 meters depth. Furthermore, a thermal pipe consisting of two loops of Ø32 mm PE-Xa pipes was installed unto 45 meters depth. The bore hole was filled with quartz sand except for zones of swelling bentonite pellets in clay layers and near ground level in order to prevent seepages of rain etc. The sand was weathered with water during and after installation. The soil samples from boring “no. 4” were geological described by VIA University College, and the natural moisture content and the gravity weight was measured. On five samples the grain size distribution has been analyzed by sieving in GEOs laboratory.

The borings showed that below a thin layer of topsoil (mull) the soil mainly consisted of glacial deposits with embedded layers of presumable interglacial strata (might have been relocated during glacial periods). Down to approx. 2 - 3 meters depth a soft (→ very soft) strata of clay till and silt was encountered. Below this a firm to stiff (→ very stiff) strata of clay till was encountered unto 8 – 10 meters depth, covering melt water deposits of very dense sand (or gravel), in which most of the CPTs stopped at maximum thrust. In 19 – 20 meters depth a layer of clay till was encountered unto 23.5 – 28 meters depth. Underneath these layers melt water deposits of fine sand and/or sandy silt were encountered with embedded layers of clay till and sand till. From 41 to 50 meters depth layers of sand/silt were encountered, presumably interglacial fresh water deposits, but they might have been relocated during a glacial period.

During drilling seepage of ground water were registered in the upper clay till, but the standpipes were dry at later soundings of groundwater tables. The borings were made in the late Winter and early Spring, whereas water from e.g. melting snow presumably has weathered the upper soil (seasonal secondary groundwater).

Below this the different soils were dry down to nearly 50 meters depth. During drilling groundwater was encountered in 49.3 meters depth. At a later sounding in the deep standpipe no groundwater table was recognized. Therefore, the groundwater table in the primary reservoir may be deeper than 51 meters (Danish Vertical Reference 1990 - DVR90 - level +69). A study of other borings in the neighborhood (using the national database of borings at www.geus.dk) indicates a groundwater table in approx. DVR90 level +65 in the primary groundwater reservoir.

These observations were confirmed by the measured natural water content, which generally was very low ($w = 2 - 8 \%$) in the sand deposits.

Thermal measurements

Two weeks after completion of boring "no. 4" a thermal response test was performed by H.S.W. GmbH., Rostock. In figure 2.1 temperatures by depth in the soil are shown – both before the test (red curve) and after the test (brown curve).

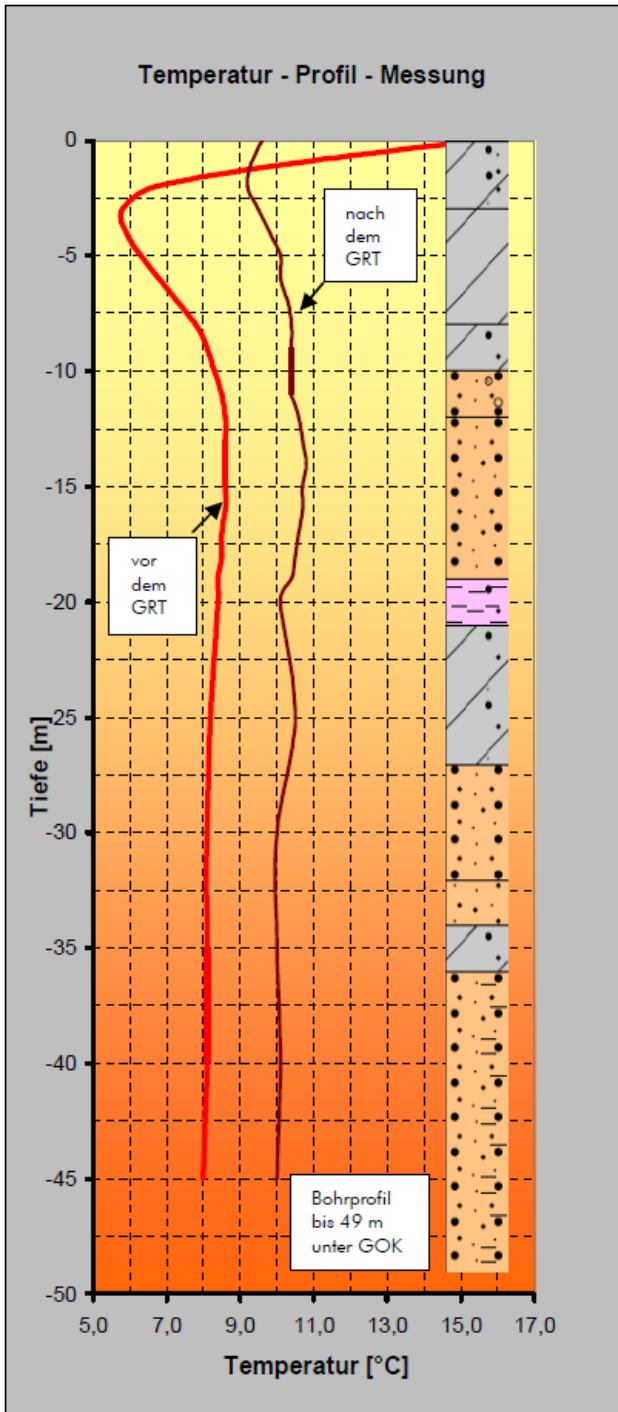

Figure 2.1: Temperature profile in boring "no. 4".

Based on calculations of the thermal response the soil was evaluated to have an overall thermal conductivity of $\lambda = 1.42 \text{ W/(m}\cdot\text{K)}$ and a thermal resistance for the actual borehole of $R_b = 0.172 \text{ W/(K/m)}$.

In addition VIA has performed laboratory tests of the thermal conductivity of eight soil samples at different depths from boring "no. 4". The results are listed in table 2.1. These values are generally

comparable with the result of the thermal response test, which represent an average value for the soil to 45 meters depth.

Sample depth (m)	Main lithology	Thermal conductivity (W/(m·K))
3-4	Silt and clay till	2.12
3-4	Silt and clay till	2.88
7-8	Clay till	3.60
18-19	Sand, medium-coarse	0.22
26-27	Sand, fine	1.69
37-38	Silt and sand	1.02
48-49	Sand and silt	0.55
49-50	Sand and silt	1.71

Table 2.2: Thermal conductivities

The heat capacity c and the volumetric heat capacity C has been estimated based on estimated unit weights, water contents and mineral distributions with known heat capacities. The results are listed in table 2.2. The values were checked by VIA by one laboratory test performed on unsorted sand, $C = 1.91 \text{ MJ}/(\text{m}^3\text{K})$.

Soil	Unit weight (kg/m ³)	Natural water content (%)	Estimated distribution of volume (%)				Heat capacity (kJ/(kg·K))	Volumetric heat capacity (MJ/(m ³ K))
			Felds par	Quartz	Water	Air		
Sand, sorted	1800	5	3	65	5	27	0.82	1.5
Silt/sand, unsorted	2000	7	8	67	7	18	0.86	1.7
Clay till	2200	13	17	66	13	4	0.97	2.1

Table 2.2: Estimation of heat capacities (above groundwater).

Conclusions of site investigation

The performed site investigation has shown that the area is suitable for a borehole energy storage, primarily caused by the fact that no horizontal groundwater flow may be expected down to (at least) 50 meters depth. The soil consisted partly of clay till, which is a relatively well suited for energy storage, and layers of less suited, dry sand.

The upper 2 - 3 meters of soil were relatively soft, but the layers below were generally stiff/dense and very stiff/very dense, which had to be taken into account in the planning of drilling method and choice of equipment for the energy boreholes.

On the basis of the performed site investigation GEO recommended to use the following average values in the design of a pilot energy storage with borings to 45 meters depth.

Thermal conductivity: $\lambda = 1.42 \text{ W}/(\text{m}\cdot\text{K})$

Heat capacity: $c = 0.9 - 1.0 \text{ kJ}/(\text{kg}\cdot\text{K})$

Volumetric heat capacity: $C \approx 1.8 - 2.0 \text{ MJ}/(\text{m}^3\text{K})$

The thermal conductivity is relatively low, primarily caused by dry sands.

2.2 Test of grouting material

Four commercial grouts were tested in order to compare the thermal properties. The grouts were mixed according to the recommendations of the producers. Two test setups were carried out.

Test one:

A setup comparable to the actual situation in the BTES was created in VIAs geology lab, see figure 2.2. Starting from the centre of the setup we see two metal pipes that are used to circulate hot water in order to transfer thermal energy to the system. The metal pipes are placed in two pipes of the same plastic material that was expected to be used in the actual borehole heat exchangers (BHE). These pipes were filled with water in order to improve the transfer of heat and simulate the real situation as much as possible. The pipes were sealed in order to reduce evaporation of the water in the pipes.

The orange pipe simulates the casing of the borehole and was removed as soon as the grout to be tested was poured in the “borehole”. The sandy material in the outer, white container is actually from the site of the BTES.

During the test hot water of known temperature was circulated in the pipes. In the “ground” outside the “borehole” thermometers were placed in the distance of 5, 9 and 13 cm from the pipes in the BHE.

The temperature development was monitored over four days. There were some difficulties in maintaining a constant temperature during the test period, but the initial measurements showed a slightly better performance in terms of heat transfer from HGD Thermo HS.



Figure 2.2: One of the lab “boreholes” during construction. The orange PVC pipe represents the casing and is removed before the test is carried out.



Figure 2.3: Experiment during test run.

Test 2:

In this test the thermal conductivity was measured in the four products by a standard Hukseflux TP 02 needle probe. Again the dry gouting material was mixed with water according to the manufacturer's description. The slurry was poured in cylinder glasses with a diameter of 10 cm. In the middle of each cylinder glass, a guiding tube for the needle probe was inserted.

The four samples were left to harden for 24 hours and the thermal conductivity was measured. The samples were then left for another 14 days and the thermal conductivity was measured again. In all four cases, the thermal conductivity was lower after 15 days than after 1 day. Also it is worth noting, that all measurements were lower than the specifications given by the manufacturers.

HDG Thermo HS again turned out to be the best performing of the four products tested. The measured lambda value was 1,65 W/mK after 1 day and 1.44 W/mK after 15 days.

3 Design of the pilot plant

Brødstrup Totalenergianlæg (Brødstrup Total Energy Plant) already had 8,000 m² solar collectors, two gas engines, two gas boilers and a 2,000 m³ accumulation tank. The pilot plant should, according to the application to Energinet.dk add a pilot borehole storage of app. 8,000 m³ soil volume, a solar thermal plant of app. 8,000 m², a 2,000 m³ buffer tank and a heat pump (app. 1 MW_{heat}), but the pilot plant should only be the next step against a full scale plant covering 50 % of the yearly consumption with solar energy.

Therefore the design of the pilot plant started with design of the full scale plant including solar collectors, accumulation tank, a full scale borehole storage and heat pumps. In the area pointed out for new solar collectors 42,000 m² of solar collectors could be placed and the accumulation tank for the full scale plant was expected to be 5,000 m³. Therefore these two parameters were fixed in the design calculations for the full scale plant. In Annex 1 a map of the area can be found.

3.1 Full scale RE system

The full scale RE system is calculated after an “onion rings approach”, see Fig. 3.1 below.

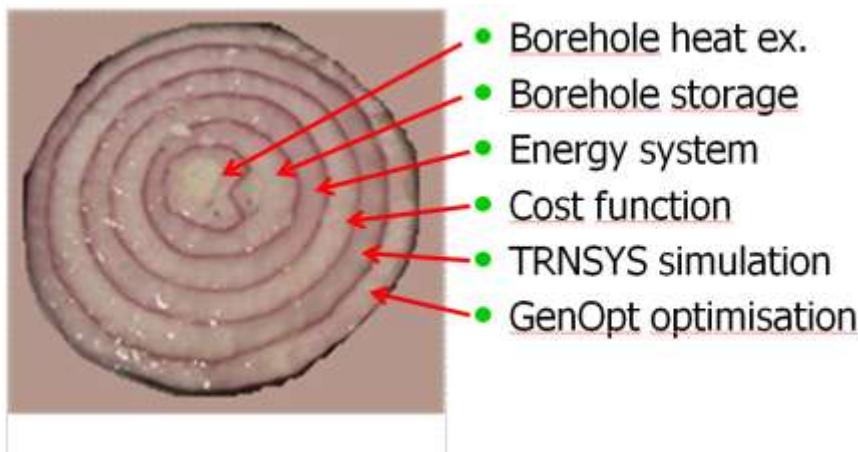

Fig. 3.1: Illustration of the “onion rings approach”.

3.2 Design of the borehole heat exchanger

The design of the borehole heat exchanger is a copy of the heat exchanger in Crailsheim

- Borehole diameter: 150 mm
- No. of U-tubes/borehole: 2

A calculated value of the thermal resistance is used (see BTES model below).

3.3 The borehole storage

Calculation of the borehole storage is carried out in TRNSYS with the DST-model, Type 557 a. The calculation methodology is explained in the DST manual: ⁴

⁴ Type 557: Vertical Ground heat Exchanger (Type 557.pdf), David, 2004

The program assumes that the boreholes are placed uniformly within a cylindrical storage volume of ground. There is convective heat transfer within the pipes, and conductive heat transfer to the storage volume. The temperature in the ground is calculated from three parts; a global temperature, a local solution and a steady-flux solution. The global and local problems are solved with the use of an explicit finite difference method. The steady flux solution is obtained analytically. The temperature is then calculated using superposition methods.

Design parameters were a.o.:

- The soil properties (heat conduction and heat capacity) are homogene inside the store volume ($1.4 \text{ W}/(\text{m} \cdot \text{K})$ and $1.9 \text{ MJ}/(\text{m}^3 \cdot \text{K})$).
- The boreholes will be 45 m deep since the ground water level is expected to be at least 50 m below the surface.
- Outside the storage volume the soil is divided into 9 layers.

3.4 The energy system

The principle diagram for the full scale energy system can be seen below in Fig. 3.2:

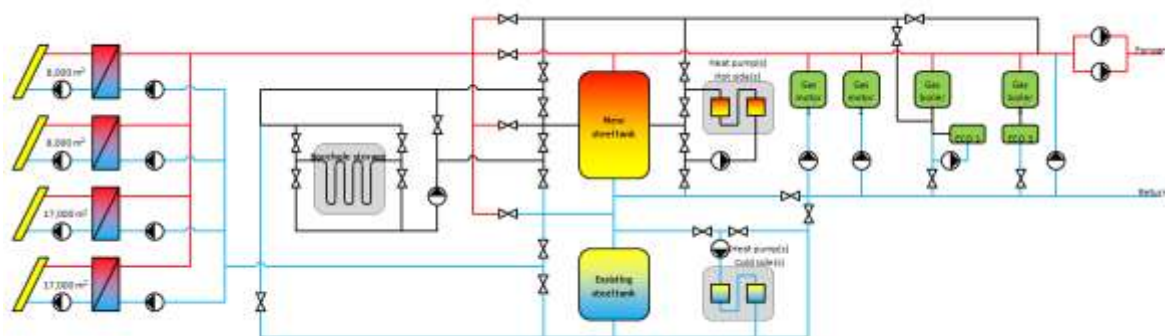

Fig. 3.2: Principle diagram for the full scale plant.

And the corresponding TRNSYS model can be seen in Fig. 3.3:

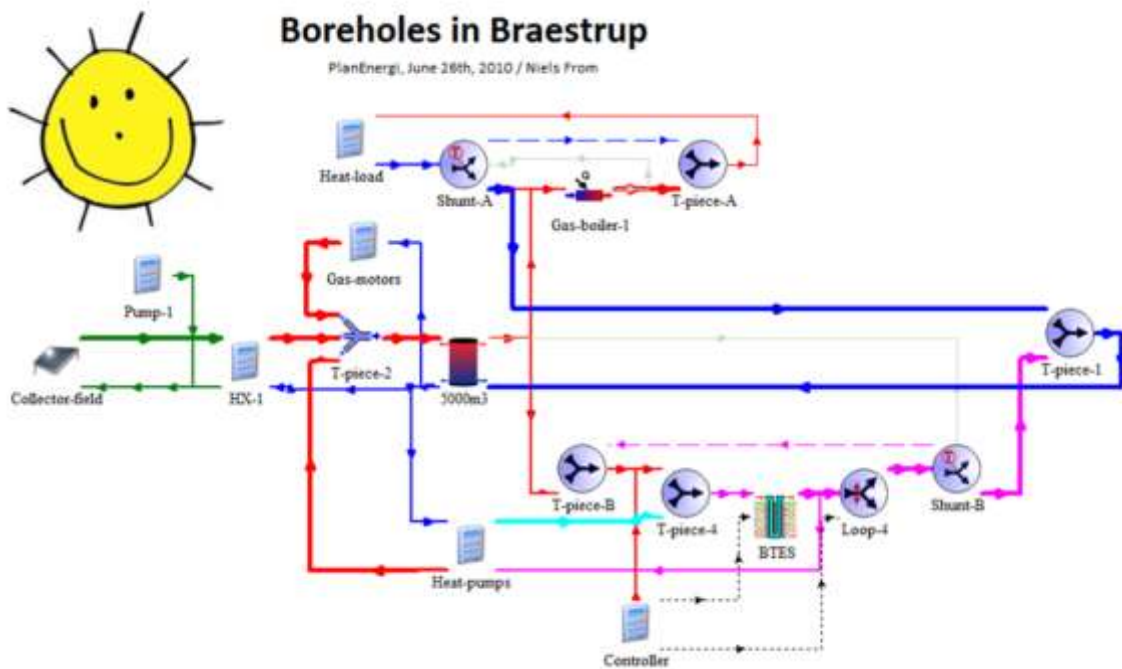

Fig. 3.3: TRNSYS model for the full scale plant.

The temperature in the borehole storage is calculated to change between 70° C in the summer and below 10° C when the storage is empty.

This is illustrated in Fig. 3.4:

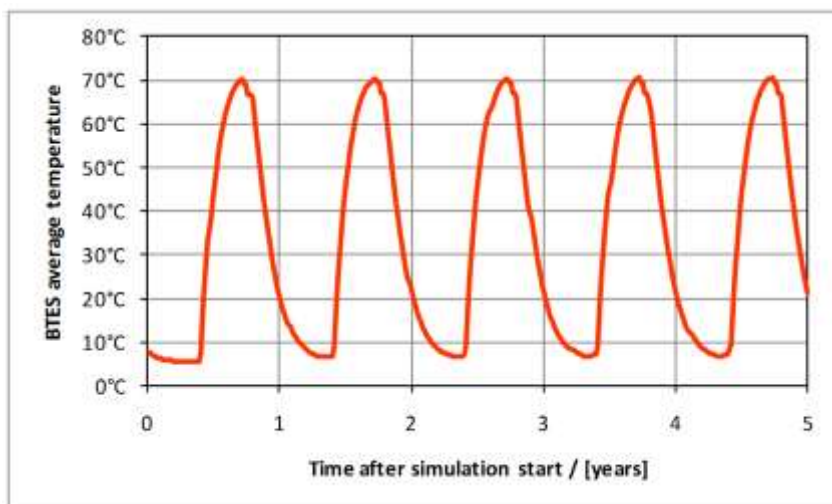

Fig. 3.4: Simulation result. BTES temperatures.

3.5 The cost function

The result of the cost calculation is the heat price calculated as

$$\text{Heat price} = \frac{\text{Operation costs} + \text{Capital costs}}{\text{Heat demand}}$$

- Prices are in DKK. 1 € = 7.45 DKK
- Operation costs are calculated for the 2nd year of the operation.
- Capital costs are calculated as 7 % of investment (Based on a 20 year annuity loan with real interest rate of 3 %)
- Heat demand is 45,000 MWh/year
- Heat production price for the natural gas boiler is calculated to 450 DKK/MWh:

Boiler	Specification	DKK/MWh
Natural gas	2.50 DKK/Nm ³	217.17
Energy tax		208.00
NO _x tax	0.008 DKK/Nm ³	0.69
CO ₂ quotas	100 DKK/ton	19.61
O&M		5.00
Heat price		450.47

Table 3.1: Calculation of heat production price from natural gas boilers (2010).

- The heat production price from motors is as an average 400 DKK/MWh.

The reference heat price is calculated in Table 3.2:

Reference	DKK/MWh	MWh/y	DKK/y
Boilers	450 *	29,550 =	13,297,429
Motors	400 *	12,300 =	4,920,000
Thermal solar	5 *	3,572 =	17,860
Heat pumps, O&M	10 *	0 =	0
Heat pumps, elec.	600 *	0 =	0
Operational costs	405 *	45,000 =	18,235,289
Capital costs	0 *	45,000 =	0
Total	405 *	45,000 =	18,235,289

Table 3.2: Calculation of reference.

Calculation of the REalternative started with an initial design.

The capital costs are calculated in Table 3.3:

Initial design	Unit price	No. of units	Price
BTES volume		400,000 m ³	
BTES depth		45 m	
BTES no. of boreholes		1,000 pcs.	
BTES (heat exchangers)	365 DKK/m	* 45,000 m	= 16,425,000 DKK
BTES (lid)	385 DKK/m ²	* 8,889 m ²	= 3,422,222 DKK
Solar collectors	1,500 DKK/m ²	* 42,000 m ²	= 63,000,000 DKK
Heat pumps	1,500,000 DKK/pcs.	* 6 pcs.	= 9,000,000 DKK
Steel tank (5,000 m ³)			4,000,000 DKK
Miscellaneous			10,000,000 DKK
Total investments			105,847,222 DKK
Payback rate ¹			7 %/y
Capital costs	165 DKK/MWh	* 45,000 MWh/y	= 7,409,306 DKK/y

1) Based on a 20 year annuity loan with effective rate of interest of 3% p.a.

Table 3.3: Capital costs for the initial design.

The initial TRNSYS calculation resulted in the heat prices in table 3.4:

Initial design	DKK/MWh	MWh/y	DKK/y
Boilers	450 *	15,522	= 6,984,983
Motors	400 *	12,300	= 4,920,000
Thermal solar	5 *	16,845	= 84,227
Heat pumps, O&M	10 *	10,405	= 104,050
Heat pumps, elec.	600 *	2,066	= 1,239,805
Operational costs	296 *	45,000	= 13,333,064
Capital costs	165 *	45,000	= 7,409,306
Total	461 *	45,000	= 20,742,370

Table 3.4: Heat prices for the initial design.

3.6 GenOpt optimisation

In the optimisation the collector area (50,000 m²) and the capacity of the accumulation tanks (7,000 m³) are frozen parameters and the optimisation parameters are

- BTES (volume, depth, no. of boreholes)
- BTES operation strategy (time for starting and stopping charging and discharging the BTES)
- No. of heat pumps (with a capacity of 1.2 MW_{heat})

The result of the optimisation can be seen in Table 3.5:

Design		Initial	Improved
BTES volume	m ³	400,000	210,000
BTES no. of bores	pcs.	1,000	553
BTES charge flow	kg/h	400,000	100,000
No. of heat pumps	pcs.	6	3
Charge start time	h	2,800	3,303
Charge stop time	h	6,600	6,706
Discharge start time	h	7,000	6,950
Discharge stop time	h	2,500	2,813
Heat price	DKK/MWh	461	442

Table 3.5: Result of the optimisation.

The GenOpt optimisation process is illustrated in Fig. 3.5. In the process a no. of TRNSYS calculations are carried out:

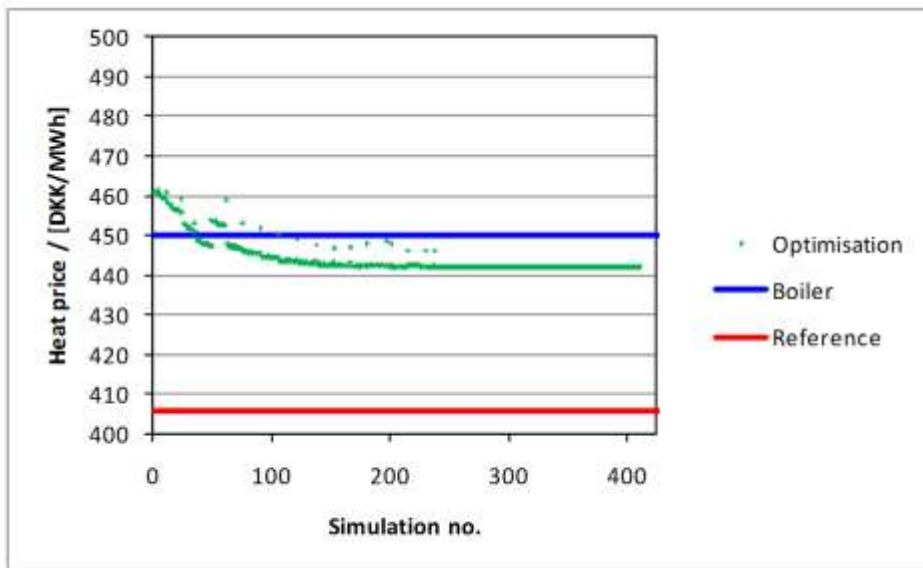

Fig. 3.5: Optimisation progress.

The capital costs for the improved design can be seen in Table 3.6:

Improved design	Unit price	No. of units	Price
BTES volume		210,000 m ³	
BTES depth		45 m	
BTES no. of boreholes		553 pcs.	
BTES (heat exchangers)	365 DKK/m	* 24,891 m	= 9,085,078 DKK
BTES (lid)	385 DKK/m ²	* 4,667 m ²	= 1,796,667 DKK
Solar collectors	1,500 DKK/m ²	* 42,000 m ²	= 63,000,000 DKK
Heat pumps	1,500,000 DKK/pcs.	* 3 pcs.	= 4,875,000 DKK
Steel tank (5,000 m ³)			4,000,000 DKK
Miscellaneous			10,000,000 DKK
Total investments			92,756,745 DKK
Payback rate ¹			7 %/y
Capital costs	144 DKK/MWh	* 45,000 MWh/y	= 6,492,972 DKK/y

1) Based on a 20 year annuity loan with effective rate of interest of 3% p.a.

Table 3.6: Capital costs for the improved design.

and the corresponding heat price can be seen in Table 3.7:

Improved design	DKK/MWh	MWh/y	DKK/y
Boilers	450 *	16,965 =	7,634,363
Motors	400 *	12,300 =	4,920,000
Thermal solar	5 *	15,938 =	79,688
Heat pumps, O&M	10 *	5,884 =	58,843
Heat pumps, elec.	600 *	1,173 =	704,094
Operational costs	298 *	45,000 =	13,396,989
Capital costs	144 *	45,000 =	6,492,972
Total	442 *	45,000 =	19,889,961

Table 3.7: Heat price for the improved design.

Design parameters can be seen in Table 3.8:

Natural gas price	DKK/Nm ³	2.50	3.00
BTES volume	m ³	210,000	255,000
BTES no. of bores	pcs.	553	703
BTES charge flow	kg/h	100,000	100,000
No. of heat pumps	pcs.	3	4
Charge start time	h	3,303	3,303
Charge stop time	h	6,706	6,088
Discharge start time	h	6,950	6,963
Discharge stop time	h	2,813	2,813
RE		35.0%	37.1%

Table 3.8: Design parameters for the improved design.

3.7 The pilot plant. Initial design

The heat production price for the pilot plant was then calculated using the following figures

- Solar collector area (8,000 m²) + 8,000 m²
- Steel tanks (2,000 m³) + 5,000 m³
- Heat pumps: 1
- BTES: 19,000 m³ with 50 boreholes
- Investment 20,000,000 DKK
- Capital costs 7 % / year = 1,400,000 DKK/year

and the result can be seen in Table 3.9:

Pilot plant	DKK/MWh	MWh/y	DKK/y
Boilers	450 *	26,669 =	12,001,052
Motors	400 *	12,300 =	4,920,000
Thermal solar	5 *	6,480 =	32,400
Heat pumps, O&M	10 *	688 =	6,881
Heat pumps, elec.	600 *	247 =	148,246
Operational costs	380 *	45,000 =	17,108,580
Capital costs	31 *	45,000 =	1,400,000
Total	411 *	45,000 =	18,508,580

Table 3.9: Heat production price for the pilot plant. Initial calculation.

The result of the initial design was thus, that neither the pilot plant nor the full scale plant was economically feasible compared to the reference situation. But it could also be seen, that the solar production was quite low (app. 320 kWh/m²/year) for the full scale plant and for the pilot plant (405 kWh/m²/year). Therefore the TRNSYS model was improved making it possible to run the system more efficient.

3.8 Full scale REsystem. Optimized TRNSYSmodel

After the first TRNSYS calculations the TRNSYS model was modified as follows:

- Cooling of solar plants and thus higher solar production was added
- Control of charging flow to the BTES was improved
- A shunt was added for discharging the BTES
- The steel tank model was changed to allow an inlet/outlet in the middle of the tank, and to improve stratification.

The result of the revised calculations can be seen in Table 3.10:

Reference	DKK/MWh	MWh/y	DKK/y
Boilers	450 *	29,550 =	13,297,429
Motors	400 *	12,300 =	4,920,000
Thermal solar	5 *	3,572 =	17,860
Heat pumps, O&M	10 *	0 =	0
Heat pumps, elec.	600 *	0 =	0
Operational costs	405 *	45,000 =	18,235,289
Capital costs	0 *	45,000 =	0
Total	405 *	45,000 =	18,235,289

50.000 m2	DKK/MWh	MWh/y	DKK/y
Boilers	450 *	16,759 =	7,541,371
Motors	400 *	12,300 =	4,920,000
Thermal solar	5 *	17,927 =	89,633
Heat pumps, O&M	10 *	4,101 =	41,011
Heat pumps, elec.	600 *	783 =	469,646
Operational costs	290 *	45,000 =	13,061,661
Capital costs	143 *	45,000 =	6,451,412
Total	434 *	45,000 =	19,513,073

Pilot plant	DKK/MWh	MWh/y	DKK/y
Boilers	450 *	25,928 =	11,667,727
Motors	400 *	12,300 =	4,920,000
Thermal solar	5 *	7,421 =	37,105
Heat pumps, O&M	10 *	560 =	5,602
Heat pumps, elec.	600 *	191 =	114,308
Operational costs	372 *	45,000 =	16,744,742
Capital costs	31 *	45,000 =	1,400,000
Total	403 *	45,000 =	18,144,742

Table 3.10: Heat production price using the improved TRNSYS model.

The result was that the pilot plant was economically feasible. The price for electricity for the heat pump and the natural gas price are important for the calculation result, and therefore sensitivity calculations were made for these parameters. The results were that a gas price of 3.00 DKK/Nm³ will reduce the difference between the reference and the full scale plant with 14 DKK/MWh, and that an electricity price of 1.00 DKK/kWh would increase the difference with 7 DKK/MWh.

3.9 Design of the borehole storage

The design of the Borehole Thermal Energy Storage (BTES) in Brødstrup was divided into the following 3 parts:

- Boreholes
- Piping
- Lid

3.9.1 Design of boreholes

The boreholes should be as deep as possible, because this will (for the same storage volume and total length of boreholes) result in the smallest lid area, thus minimizing the lid cost and the heat loss through the lid.

To avoid the storage from being cooled by flowing ground water, the bottom of the boreholes should end at least 5 m above the highest ground water level.

There could be seasonal variations of the ground water level.

The ground water level is expected to be at least 50 m below the surface.

The boreholes are therefore 45 m deep.

The number of boreholes in the pilot storage was decided to be 48.

The number of boreholes in the full scale storage is expected to be approx. 10 times higher, e.g. 480 boreholes in total.

For the full scale storage the optimum cross sectional area of a single borehole was found to be approx. 7.76 m^2 (Fig. 3.6).

Fig. 3.7 shows the shape of the cross sectional area (in grey color) of a single borehole for 3 different borehole patterns: Circular, square and triangular.

The circular pattern is the ideal situation; however, this is not possible in real life. Instead, a square or a triangular (i.e. hexagonal) pattern can be used.

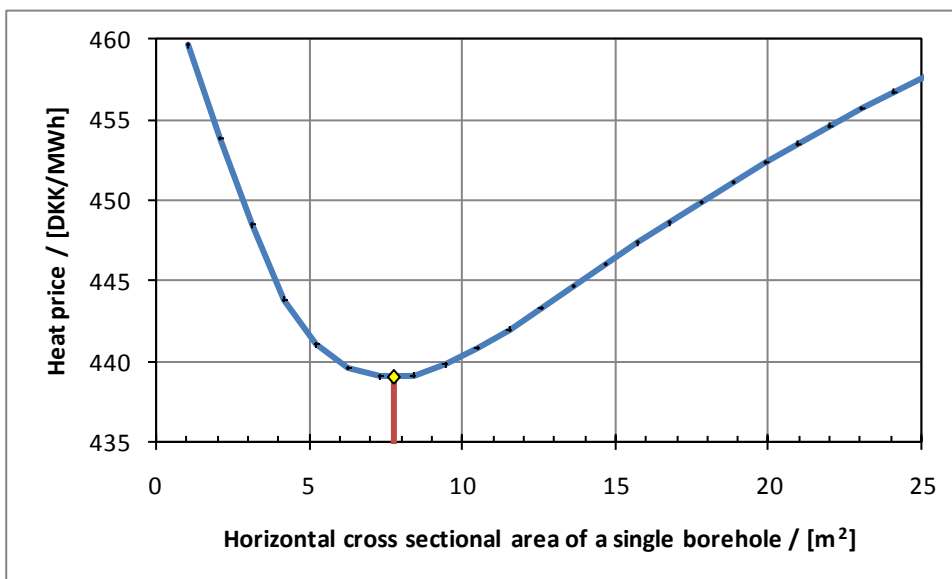

Fig. 3.6: Heat price as a function of the cross sectional area of the boreholes.

To obtain the optimum cross sectional area of 7.76 m^2 , the distance (D) between two neighbor boreholes should be:

- For circular area: $D \approx 3.14 \text{ m}$
- For square area: $D \approx 2.79 \text{ m}$
- For triangular area: $D \approx 2.99 \text{ m}$

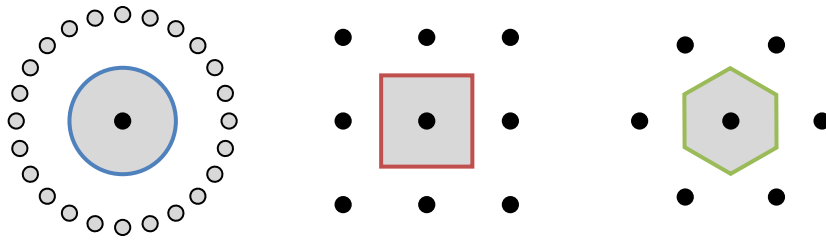

Fig. 3.7: Top view of the borehole volumes for the ideal situation, a square pattern and a triangular pattern.

A drilling can be deflected from the vertical line by e.g. stones. Therefore, the drilling company had stated that the minimum (safe) distance between the boreholes is 3.0 m in order to avoid damage on a finished borehole when the neighbor boreholes are drilled.

With a safe distance of 3.0 m it was not possible to obtain the optimum cross sectional area with a square pattern (because 3.0 m > 2.79 m). Choosing a triangular pattern instead, the safe distance almost corresponds to the optimum area.

This was the main reason for choosing that the boreholes will be placed in a triangular pattern. This is different to the square patterns in Neckarsulm, Crailsheim and Drake Landing Solar Community.

3.9.2 Design of piping

The water flow in the pilot storage was in the TRNSYS calculation decided to be 25 m³/h.

The transmission line between the storage and the building is approx. 600 m long. Thus the dimension of the transmission line will be DN 100 (twin), resulting in a pressure drop of approx. 0.6 bar.

The design of the pipes and fittings is similar to the solution in Crailsheim. Thus the material of the pipes in the boreholes (and between the boreholes) was decided to be **RAUGEO collect PE-Xa plus SDR 11** (with build in oxygen barrier).

The dimension of the pipes in the boreholes (and between the boreholes) was decided to be DN 32 (32 × 2.9 mm).

The number of U-pipes in each borehole will be 2.

The reason for having 2 instead of 1 U-pipe in each borehole was that this will reduce the thermal resistance between the water and the ground, as well as a borehole will still be in operation even if one of the U-pipes has to be cordoned off, e.g. due to a leak.

The manufacturer of the probes was decided to be Rehau.

The PE-Xa pipes are connected with press fittings.

The press fittings are **REHAU Kupplung egal, SDR 11, art.nr. 139302-001** and **REHAU Schubebehülse, SDR 11, art.nr. 139492-001**.

The press fittings are buried under the lid, i.e. not available for inspection or service.

The PE-Xa pipes are connected to manifolds.

In the pilot storage the manifolds are made by ARCON Solar.

The manifolds are placed in wells, i.e. available for inspection and service.

In the pilot storage the number of wells is 1 (in the center of the storage, Fig. 3.8).

The U-pipes was decided to be connected both in series and in parallel. Having all U-pipes in series (one string) will result in a too high pressure drop, and having all U-pipes in parallel will result

in a too low pressure drop, which will make it difficult to obtain a uniform flow distribution, as well as a need for many meters of pipes to connect the U-pipes to the manifolds. Therefore, a compromise between the number in series and the number in parallel had to be found.

The (total) pressure drop in the storage should not be too high, because this will reduce the maximum allowed temperature of the water in the pipes due to the material specifications, as well as increase energy consumption of the pump. On the other hand, the pressure drop should neither be too low, because this will make it difficult to obtain a uniform flow distribution. 2 bar was assumed to be a reasonable value of the pressure drop.

The number of U-pipes in series was 6.

In the pilot storage there was therefore calculated to be $2 \times 48 / 6 = 16$ parallel flow strings.

The (total) pressure drop in the storage is calculated to approx. 2.0 bar.

String regulating valves would not be necessary (but later on it was decided to have them anyhow as a safety. After running in it was confirmed that the flow distribution was uniform, and subsequent that the string regulating valves was not necessary).

The sensitivity of the flow distribution to different lengths of strings is low. If $\Delta p = \frac{1}{2}\rho v^2 L \Leftrightarrow v = \sqrt{2\Delta p/\rho L}$ a difference in length of 10% will result in a difference in flow of approx. 5%.

This result was confirmed by a more detailed calculation.

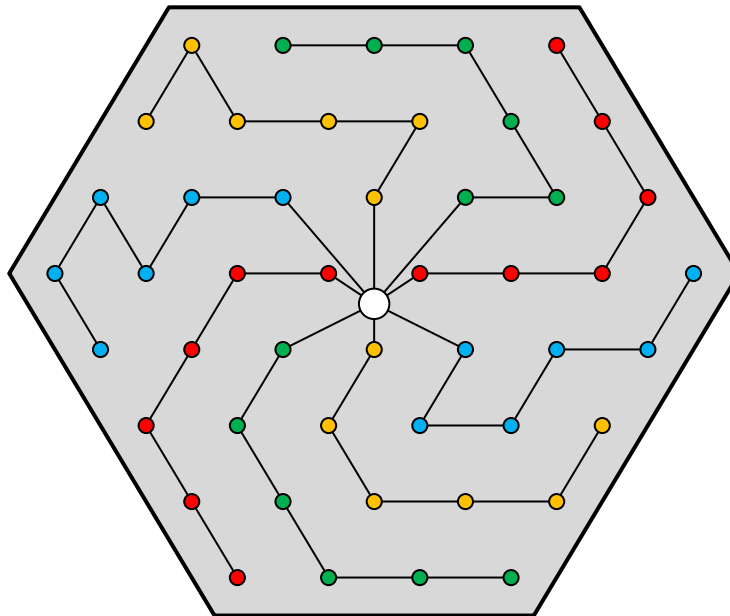

Fig. 3.8: Pipe layout for the pilot borehole storage. Only connections to one of the U-pipes in each borehole are shown. The pipe layout for the second U-pipes will be mirrored through a vertical line to minimize the number of boreholes shared by two flow strings. All “dead ends” are connected to the well in the center.

The full scale storage (FSS) will be placed around the pilot storage. The FSS will be hydraulic separated from the pilot storage, a.o. they will have separate transmission lines.

A number of wells will be placed at the border of the pilot storage, and a number of wells will be placed at the border of the FSS (Fig. 3.9).

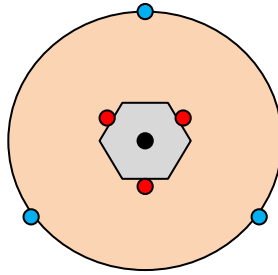

Fig. 3.9: Full scale storage. Flow strings will start at a red well and end at a blue well (i.e. direction of flow when charging the storage).

Preliminary data for the FSS is:

- Number of boreholes: 432
- Number of U-tubes pr. borehole: 2
- Number of boreholes in series: 6
- Number of parallel flow strings: $2 \times 432 / 6 = 144$
- Number of wells: $2 \times 3 = 6$
- Number of pipes/terminations/strings in each well: $2 \times 144 / 6 = 48$

The length of a flow string with 6 boreholes will be $6 \times 2 \times 45 \text{ m} = 540 \text{ m}$ plus connecting pipes. The length of the connecting pipes will be between approx. 40 and 80 m, giving a total string length between 580 and 620 m, or $(600 \text{ m} \pm 3.3\%)$.

The variations in the length of the strings will result in differences of the flow in the strings. The string flow will be between 1.70 and $1.77 \text{ m}^3/\text{h}$, or $(1.73 \text{ m}^3/\text{h} \pm 1.9\%)$. The differences in the flow in the strings are so small that the length of the connecting pipes will be kept as short as possible, partly to keep the costs down and partly to get an orderly working area when connecting the pipes.

3.9.3 Design of the lid

The lid has three functions:

a. Insulation.

The insulation material must be resistant to humidity and high temperatures (up to 80°C).

It must not attract humidity. It must be cheap. The optimal thickness of the insulation is found by simulations in TRNSYS including a cost function.

b. Carrying capacity.

It should be possible to drive on the top of the lid with ordinary cars. This demands a carrying capacity of app. 30 kN/m^2 .

c. Draining of rain water.

Rain water must not penetrate the lid and enter the insulation. It should be drained away to the surroundings.

Two materials only have been found to meet the criteria above:

A. Foam glass gravel (used in Crailsheim)

This material fully meets the demands regarding resistance to humidity and temperature. The single nuggets have a size of 30 to 60 mm and the material is hence not hygroscopic. The price

delivered in Brædstrup will be app. 80 € pr. m³. The lambda value is 0.08 W/mK, but convection is likely to occur because of the relatively large nuggets (compression can lower the permeability, but mainly in the upper part of the insulation).

B. Mussels shells

Denmark has a large production of mussels, and the shells are a waste product, which is used for soil improvement etc. They have however also been tested for insulation purposes and found to have reasonable lambda values of 0.112 W/mK (crushed to 60% volume) and 0.12 W/mK (whole). The price is app. 10 €/m³ delivered only.

The material has been tested for insulation of floors and roofs in alternative house designs, but has not before been used for purposes similar to the actual.

For this reason a number of tests have been carried out:

1. How manageable is the material in practice?
2. Will it damage the PEX tubes when compressed on site?
3. What is the carrying load of shells compressed to app. 60% volume?
4. Will convection occur in the lid?

ad 1) To test the manageability some 10 m³ of shells were bought at a quality which can also be supplied in large amounts. The shells were filled in a hole with dimensions 2 * 3 * 1 m. During the filling a 32 mm PEX tube was placed in the shells in a way where impact on the tubes could be assessed for different heights from the bottom (app. 5 and 40 cm).



Then the shells were compressed by the wheels of a small FWD loader (750 kg). By driving about 5 times over each area the shells were compressed to the planned 60% volume.



The gradual compression was carried out without problems (no tendency to sink into the shells). After completing the compression the tubes were heated and left to cool down in four hour cycles for two weeks. This was done to simulate actual operation in the storage.

ad 2) When the shells were removed the tubes were cleaned and inspected visually. No damage was found except for the vertical parts of the tubes used for connecting the tubes to the heating system. The wheels of the loader had more or less direct contact with these parts during the compression.

ad 3) The carrying load was assessed by placing the front wheels of the loader on tiles of well defined area. When loaded with 250 kg of concrete slabs most of the total of 1000 kg was concentrated at the front wheels. It was found that a load of 40 kN/m^2 caused further compression of about 1 mm at the first loading. For subsequent loadings no further compression could be measured.



ad 4) Regarding convection in insulations which are heated from below the guidelines of the EN ISO 10456 standard calls for the modified Rayleigh number to be less than 30. It is calculated by the following formula:

$$Ra_m = 3 * 10^6 * d * k * \Delta T / \lambda$$

d = thickness of the insulation, in [m].

k = permeability of the insulation, in [m^2].

ΔT = temperature difference across the insulation, in [K].

λ = thermal conductivity without convection, in [W/(mK)].

It follows that the number is proportional to the height of the layer, the temperature difference and the permeability of the material. From experiments carried out on expanded clay the guideline regarding Raleighs number has been verified. For 50 cm height and 70 K difference, it was found that a quality with 'balls' of 2 to 4 mm could be used while the use of 4 to 10 mm required the use of a separating foil in the middle, which decreases the Raleigh number with a factor four.

From a simple experiment where air was blown through a 30 cm layer it was found that the permeability of the compressed shells is comparable to the 4-10 mm expanded clay material. Hence it was expected that a separating layer would be needed for the shells.

As permeability is difficult to measure at the very low air speeds which are relevant for these considerations it was decided to repeat the convection experiment with the relevant conditions.

A well insulated box was heated from below with a fixed input (stabilized DC supplies). Three test were carried out with 2-4 mm expanded clay, compressed shells with a separating foil and compressed shells without separating foil.



Compression of shells in small scale!

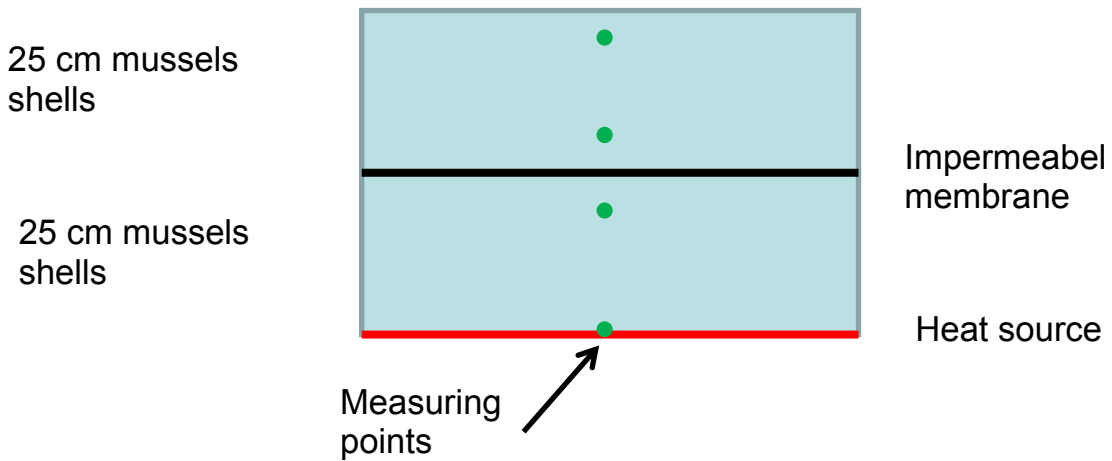

Fig. 3.10: Position of temperature measuring points during the experiment.

The graphs below show the results of the first two experiments. It is seen how the temperatures stabilized in about 6 days.

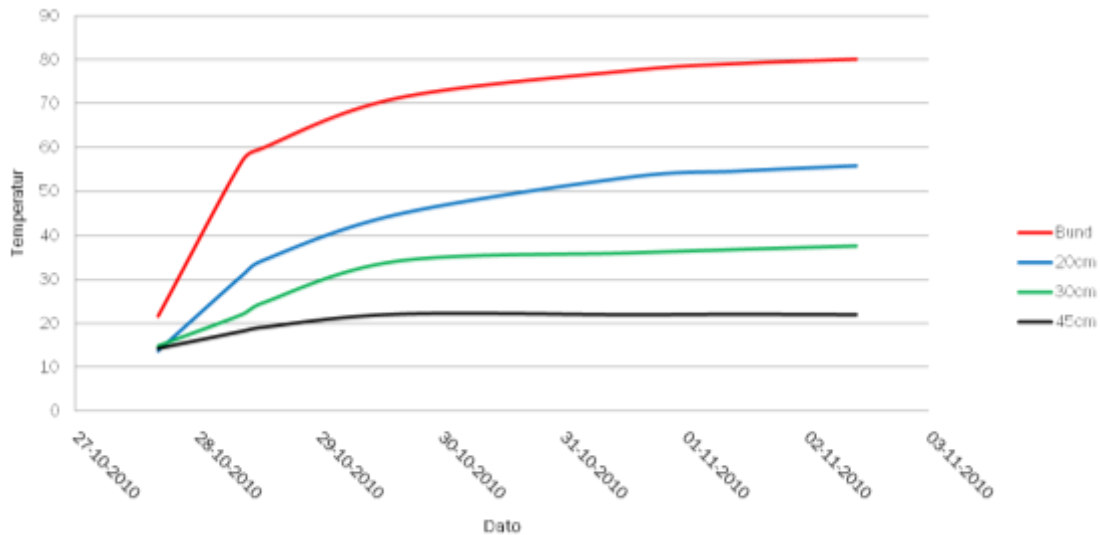

Fig. 3.11: Measured temperatures with expanded clay (bund = bottom).

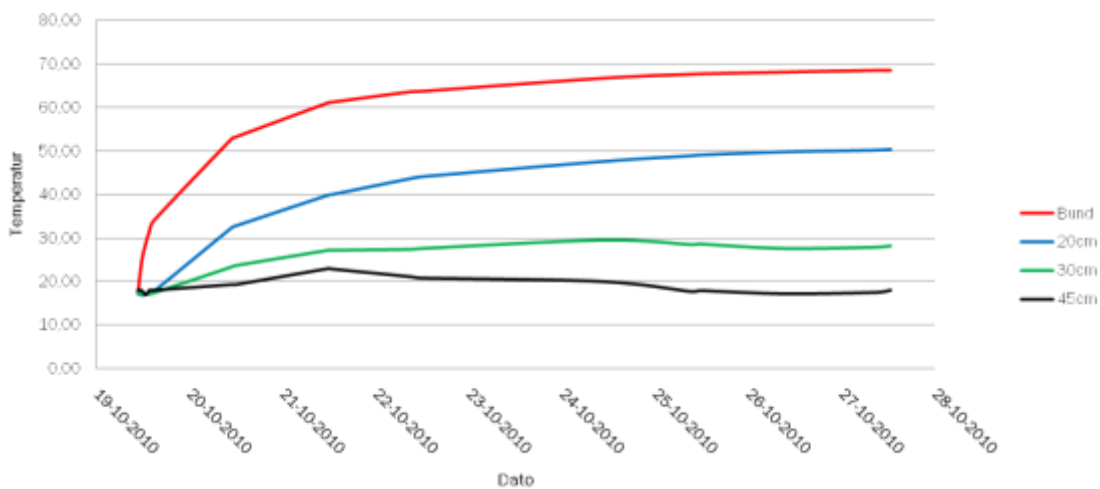

Fig. 3.12: Measured temperatures with mussel shells with separating foil.

It is seen from Fig. 3.11 and Fig. 3.12 that the established temperature difference is app. 58 K for expanded clay and 50 K for the shells. As losses through the bottom and sides can be neglected it follows that the lambda value of the shells is about 16 % higher than the lambda value for the expanded clay. As this value is well defined and verified to be 1.04 W/mK at the actual conditions an estimate for the lambda value is 1.21 W/mK. This is close to the formerly measured value of 1,12 for whole shells. (This is probably the most relevant value to compare with because compression mainly takes place in the top of the material). As the former measurement of lambda value was carried out with standard conditions (20°C) and lambda values normally increases with temperature it is concluded that one separating layer is sufficient to avoid convection in the given case.

To be sure that the separating layer is necessary an experiment without this layer was performed. The temperature difference in this experiment stabilized at app. 32°C which proves that the separating is indeed needed.

On this background mussels shells with one separating layer was chosen.

The final design of the lid is shown in Fig. 3.13:

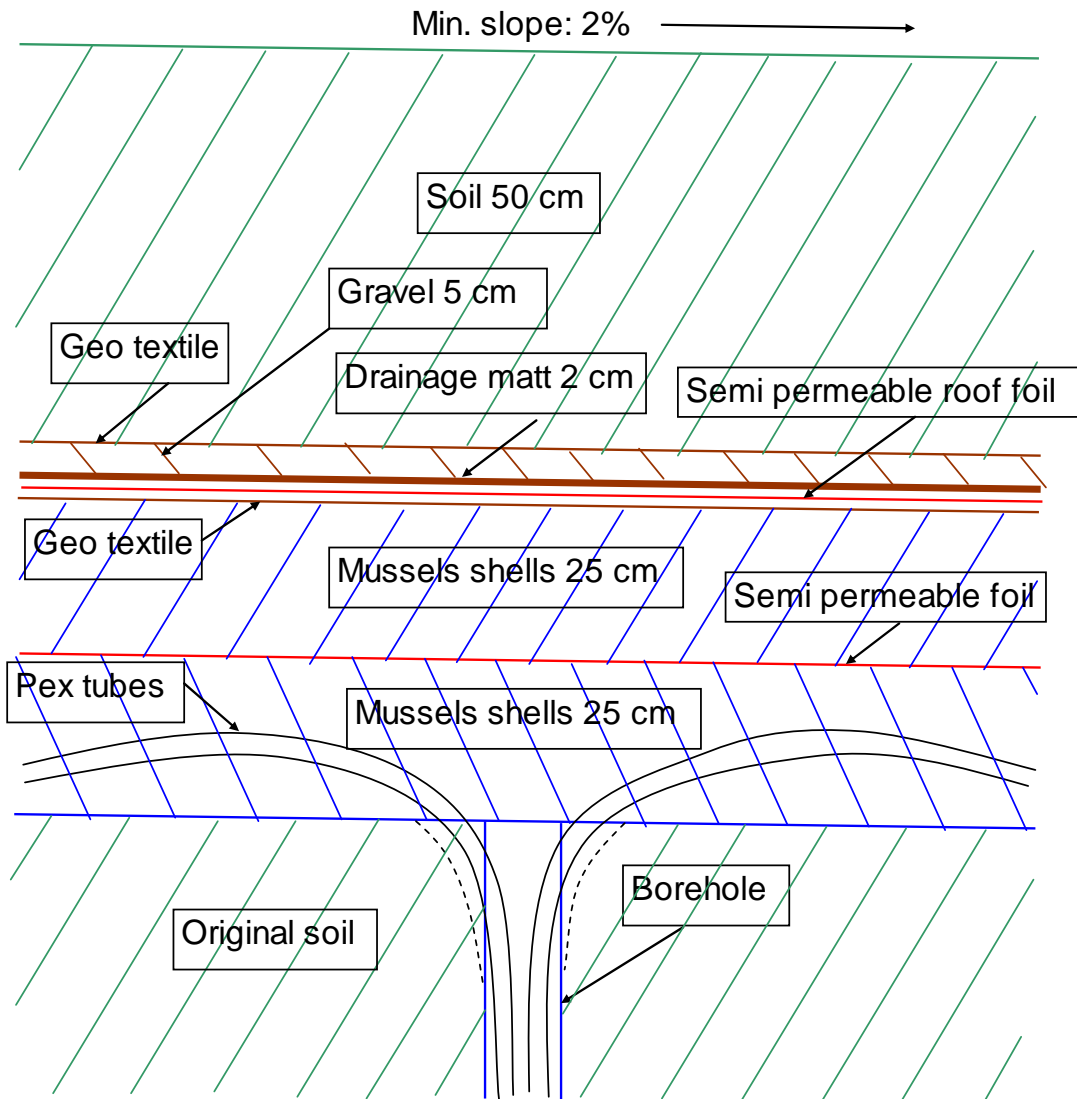

Fig 3.13: Design of the lid.

In the bottom the top of a borehole is shown. The top of the hole is modified to allow the pex tubes to leave the hole without sharp curves. After the tubes have been connected and tested for leaks the first part of the insulation is installed. The shells are installed by a loader similar to the one used in the experiment. The loader places the shells in front of the wheels in order to protect the tubes. When the first part of the insulation is sufficiently compressed the separating layer is installed. It consists of an ordinary foil used in the building industry under tiled roofs to stop the wind without stopping humidity to leave the house.

On top of this a new layer of shells is placed and compressed. This in turn is covered by a non woven geotextile which has the function of protecting the semi permeable roof foil type DOW Roofmate MK. This foil is suited to stop rainwater from entering the isolation but to allow humidity to pass from the relatively warm insulation into the soil above. The roof foil is protected from above by a drainage matt consisting of two layers of geotextil with a woven grid of polycarbonate in between.

To further facilitate the drainage of rainwater a 5 cm layer of gravel is placed on top of the matt. To maintain the drainage capacity of the gravel a further geotextile is placed on top of the gravel. 50 cm of soil finalize the cover.

The budgeted costs of the lid are calculated in the table below.

The diameter of the circular area with the boreholes is 22 m.

The thickness of the insulation is gradually decreased in an border area with the width 6 m.

The amount of insulation is calculated using a mean diameter of 28 m, while the roof foil extends to a diameter of 34 m. The top soil finally covers an even bigger area of diameter 36 m.

First price estimate is shown in Table 3.11:

			Dkr
Top soil 0,5 m *)	3 kr/m ³	1017*0,5*20	10.170
Geotextile *)	10kr/m ²	907*10	9.070
Gravel 0,05 m (on site)	100 kr/m ³	907*0,05*100	4.535
Gravel build in		2 men, 1 machine, 1 day	7.500
Drainage matt *)	90kr/m ²	907*90	81.630
Roof foil *)	25kr/m ²	907*25	22.675
Geotextile *)	10kr/m ²	907*10	9.070
Shells on site	75 kr/m ³	615*0,25/0,6*75	19.219
Shells build in and comp.		3 men, 1 machine, 2 days	20.000
Separating foil *)	25 kr/m ²	615 *25	18.200
Shells on site	75 kr/m ³	615*0,25/0,6*75	19.219
Shells build in and comp.		3 men, 1 machine, 2 days	20.000
Total			241.288
*) incl. build in			1 € = 7,45 Dkr

Table 3.11: First price estimate of the lid (266 DKK/m² or 36 €/m²) excl. well.

4 Tendering

4.1 The solar plant and the buffer tank (main supplier)

Brødstrup Totalenergianlæg wanted one entrepreneur to take as much as possible of the responsibility during the implementation phase. Since the largest entrepreneur is supplier of the solar plant, they decided to ask for prices from two solar suppliers at a very early stage in the implementation process. ARCON Solar and SUNMARK were asked. They got the diagram in Fig. 4.2, the calculated flows in Annex 4, a map of where to place the solar collectors (Annex 5) and the sizes of the accumulation tank and the solar thermal plant.

Both suppliers gave a price for a total solar plant including accumulation tank and connection to the borehole storage. ARCON was chosen having the most economically feasible offer.

The idea with taking a main entrepreneur at an early stage was to start a partnering process with the entrepreneur. A contact with ARCON Solar was made in December 2010, and until the implementation detailed design was made by ARCON supported by PlanEnergi.

In the contact with ARCON Solar it was decided that the solar thermal plant should be extended to 10,600 m² and the buffer tank to 5,500 m³ and that the foundation of the solar collectors should be changed to punctual foundation (same foundation as used in the solar thermal plant in Broager).

4.2 Drilling of boreholes

Per Aarsleff A/S is partner in the project and had participated in the initial design work until June 2010 giving prices for drilling the boreholes and placing pipes (probes) and grouting. Brødstrup Totalenergianlæg asked Per Aarsleff and three other companies of prices for this work and ended up with Poul Christiansen A/S as drilling entrepreneur since they gave the lowest price.

4.3 Heat pump

Already in Spring 2010 the project was in contact with Johnson Controls, because they were developing a new type of high pressure screw compressor for an ammonia heat pump and looked for a place to make the site test of the heat pump. The data for the heat pump can be seen in Fig. 4.1 below:

HPSH1510 high pressure screw ammonia heat pump



Specifications for prototype:

- Refrigerant: R717 (ammonia)
 - Drive: 400kW VFD 6000RPM
 - Heating capacity: ~1500kW@6000RPM (TC=80°C/TE:=33°C/COP=4,5)
 - Design pressure: 52 bar (block = 55 bar)
-
- Condensing temperature: +84°C
 - Evaporating temperature: +6,4°C to +33°C
 - Max. water outlet temperature: +90°C

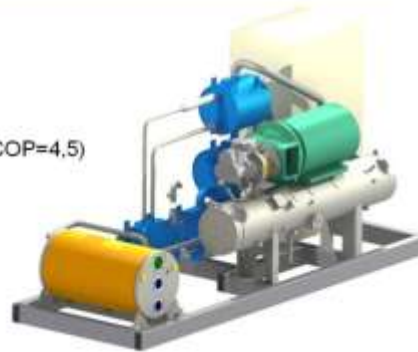

Fig. 4.1: Specifications for the heat pump.

Brødstrup Totalenergianlæg was interested in testing this new type of heat pump with a new single stage screw compressor because of the expected efficiency in an energy system with boreholes. Therefore Johnson Controls was chosen as supplier of the heat pump and a contract with site test of the new heat pump was made.

4.4 Control system

YIT is supplier of the existing control system in Brødstrup. Brødstrup Totalenergianlæg wanted to have the same supplier of the extension of the system caused by the borehole project. Therefore YIT was chosen as supplier of the control system.

4.5 Ground work and punctual foundation for solar collectors

A local entrepreneur, Jens Jørgensen A/S was selected as supplier of ground work and punctual foundation for solar collectors.

4.6 Pipes, valves etc. at the secondary side of the heat exchanger

Three companies were asked to give prices for the pipework, connecting the secondary side of the solar collectors with the existing district heating plant. YIT was cheapest and was chosen to the work.

4.7 Pipe and lid construction in the borehole storage

Brødstrup Totalenergianlæg decided to use own employees to the implementation of the lid.

5 Authorities permissions

The types of applications, authorities permissions necessary for the project were:

Notification of environmental impact of the plant according to Law of Planning (VVM). Horsens Municipality made a VVM-screening and the result was that a VVM statement was not necessary.

Environmental assessment

An environmental scoping was carried out by Horsens Municipality. Questions were sent from Horsens Municipality to GEO, who made an environment report and after that Horsens Municipality made the environmental assessment.

Local plan and add on to the municipal plan

The local plan and add on to the municipal plan was made by Horsens Municipality. It was sent in public hearing for 8 weeks. The only comments were that the soccer area south of the solar collector field (see Annex 1) was too near the housing area south of the solar collectors.

Environmental permission

GEO made a notification for environmental permission for the borehole storage. Permission for the solar collector field was not necessary. A part of the work was to prove, that the ground water temperatures was kept below 20° C. For that purpose SOLITES made a special TRNSYS version, where temperatures outside the storage could be calculated and PlanEnergi carried out calculations of the temperatures.

Building permission

Building permission was needed for the building with heat exchangers, heat pump and pumps and for the accumulation tank. Building permission was not necessary for the solar collectors.

Notification of drilling

The notification shall be sent to the municipality and if they do not react within two weeks, the work can start.

Project proposal

The project proposals purpose is approval of the project according to Law of heat supply. The project proposal shall show, that the project is social economic feasible compared to the present situation (reference).

The work with authorities permissions was by Horsens Municipality carried out by a "Task Force" including employees from the different departments where permissions should be given. That was a great advantage for an innovative project.

The work started in Summer 2010 and the last permissions were given in the beginning of March 2011.

6 Implementation

The result of the detailed design phase was a P&I diagram including all valves, pumps, meters etc. The corresponding principle diagram can be seen in Fig. 6.1 below.

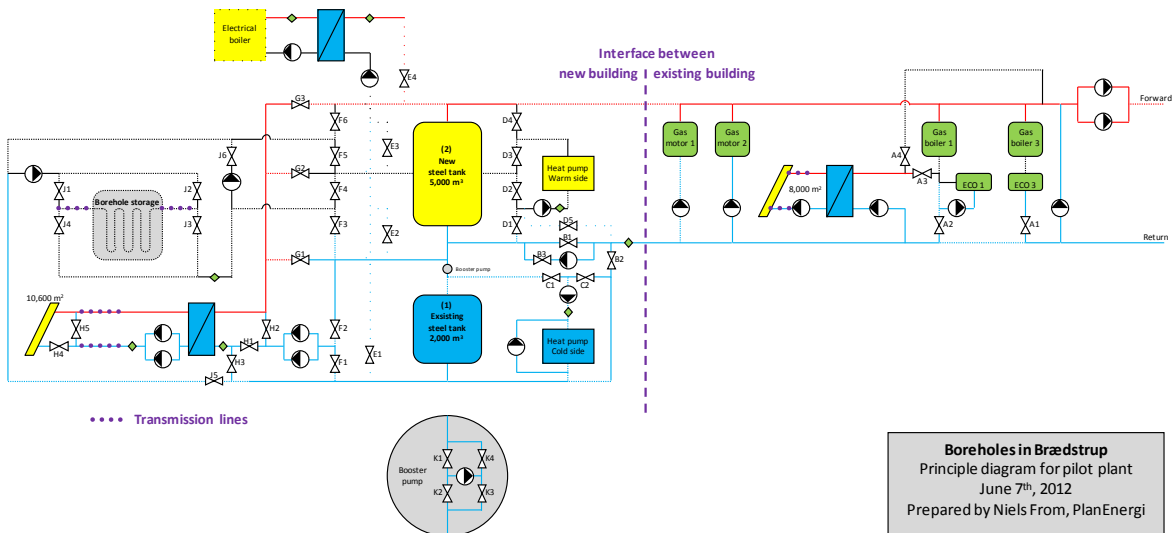

Fig. 6.1: Principle diagram for the implemented plant in Brædstrup. Can also be found as Annex 6.

The electrical boiler was added because Brædstrup Totalenergianlæg wanted a demonstration plant, where all future elements of electricity regulation were included. The electrical boiler has a capacity of 10 MW.

In the following chapters the most important lessons learned are listed.

6.1 The boreholes

Drilling is made as a wash drilling down to 47 m since the length of the propes is 45 m and the weight in the end app. 1 m. Diameter is 15 cm but larger in areas with soft material.

Lessons learned: In the south-east area there was a stone layer where the drilling material broke. It took very long time to replace the broken drilling material and the drilling was more expensive for Brædstrup Totalenergianlæg because a contract for drilling normally gives the entrepreneur possibility to get extra payment for unexpected conditions. Also the consumption of grouting was larger than expected because of the volume of the boreholes caused by wash drilling.



Fig. 6.2: The boreholes are placed



Fig. 6.3: Drilling of boreholes (1)



Fig. 6.4: Drilling of boreholes (2)

6.2 The lid construction

PlanEnergi made a manual for the lid construction and this manual was followed by Brædstrup Totalenergianlæg.

One change was that the season for mussels stopped and therefore cockles had to be used. Cockle shells are not clean and had therefore to be washed, and they cannot be compressed to 60 %. Actually compression was nearly not visible.

Lessons learned: The estimated price for the lid was too low because the amount of man hours was underestimated. Especially it took longer time than expected to put together the pipes and to install the pipes in the well. Mussels shells were not available in the long period in 2011. Therefore cockle shells had to be used. Cockle shells are filled with meat and therefore had to be washed in a gravel washing plant. The lambda value is expected to be app. the same as for mussels shells, but they don't have to be compressed to 60 % because of smaller size of shells.



Fig. 6.5: Connection pipes and well

Also the price of the well was underestimated.



Fig. 6.6: Cockle shells and connection pipes



Fig. 6.7: Cockle shells in place



Fig. 6.8: Geo textile and semi permable roof foil placed upon cockle shells



Fig. 6.9: Manifolds in well. Uninsulated left and connected and insulated right

6.3 The buffer tank

The 5,500 m³ steel tank was build up on site. That is a routine operation. But it could only be placed on an area with filled up material.

This material had to be removed and afterwards sand had to be filled in and compressed so that the top of the new steel tank was in the same level as the top of the existing steel tank.

Lessons learned: A booster pump had to be installed to avoid too large differences of top water levels in the tanks when they are serial coupled.



Fig. 6.10: Accumulation tank before insulation



Fig. 6.11: In- and outlet in mid and top of accumulation tank

6.4 The solar plant

The solar plant is a standard product, but the punctual foundation was only implemented in one place (Broager) before the implementation in Brødstrup. The solution in Brødstrup was copied from Broager.

Lessons learned: Implementation of the punctual foundation had at least 3 failures:

- Some of the foundations were not precisely placed
- The concrete foundation was not made in one working process
- The concrete was not able to stand outdoor conditions for more than a few years.

That meant that all (more than 3,000) foundations had to be replaced by new ones.



Fig. 6.12: Punctual foundation for solar collectors



Fig. 6.13: Solar collectors and borehole storage implemented

6.5 The heat pump

The heat pump is a new type. After the site test Brædstrup was willing to buy the heat pump if it could fulfill the contractual conditions.

In Annex 7 it is proved that the conditions are fulfilled, so Brædstrup Totalenergianlæg has now bought the heat pump.

Lessons learned: Safety rules for combining ammonium heat pumps with other machinery, rules for automatically opening of doors and windows, and noise protection of heat pumps are new areas for district heating engineers and companies.



Fig. 6.14: *The heat pump*

6.6 Piping of the secondary side of heat exchangers

The piping on the secondary side of the heat exchangers connects the heat exchangers with the existing plant. A new building was implemented for that and for the heat pump and the electrical boiler.

Lessons learned: The piping is prepared for the full scale solution. That means expensive dimensions and valves. This decision was taken during the design period and thus the costs were not included in the budget in the application to ForskEL. An additional application was therefore sent to ForskEL and EUDP.



Fig. 6.15: Solar heat exchanger



Fig. 6.16: Piping at the secondary side

6.7 The control system

The control system is designed in a partnering process with YIT (and later on INTEGO) as responsible for detailed design and implementation. PlanEnergi is responsible for the control strategy.

Lessons learned: The partnering process has an advantage because the control system can be developed in co operation between utility, consultant and supplier. But the disadvantage is that responsibility can be difficult to place if something goes wrong. Also the control system was not fully tested when the new solar plant was started in end of May 2012. This meant that night cooling was not 100 % effective when running in took place and it resulted in a more difficult first week. The control strategy is described in chapter 8.

7 Measuring programme

7.1 Measuring programme

This section describes the measuring programme for the solar thermal part of the Brødstrup Fjernvarme energy system. This includes a definition of necessary sensors and locations for sensor installations as well as recommendations with respect to type and accuracy of sensors and recording of data. For the main evaluation of monitoring data on system level, component level and for optimizations of the control strategy formulas and information are given.

7.1.1 Aims of Measurements and Evaluation

The main purposes for doing measurements and evaluation in the case under consideration are the following:

- To get insight in system and component behaviour and interaction
- To enable for an optimisation of the system, components and the control strategy
- To be able to derive design improvements for similar upcoming plants
- To demonstrate efficiency and feasibility

These aims are to be reached by means of:

- Short term component analysis and characterisation
- Monthly and long term energy balances

7.1.2 Definition of the measuring programme

In the following sections a recommended sensor list, sensor specifications as well as the requirements for the data collection and storing are given.

7.1.3 Sensors for system energy balance

Basis for the following explanations is the principle diagram for the pilot plant from PlanEnergi, dated 03.2011.

Fig. 7.1 shows the system energy balance and all participating energy flows of the considered part of the energy system. For the electrical boiler circuit and the connection to the existing system the auxiliary electric energy for circulation pumps is neglected.

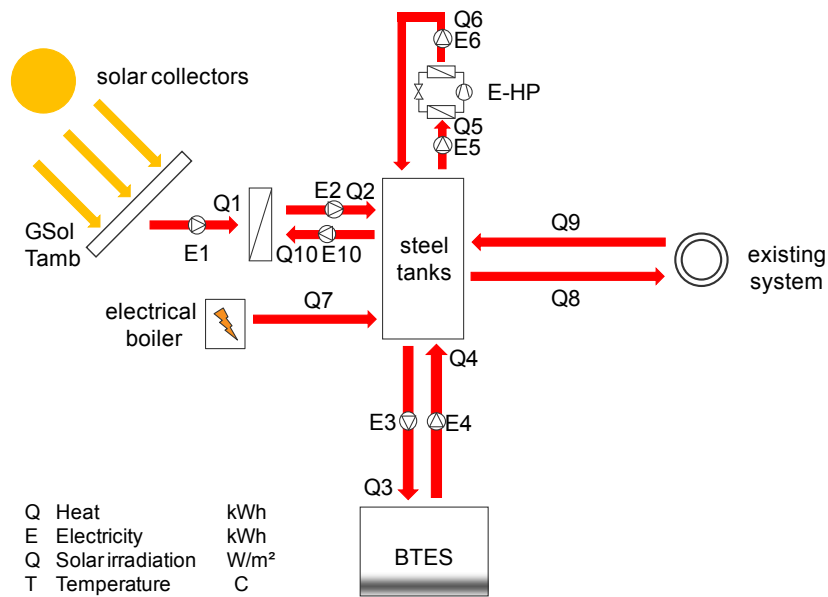

Fig. 7.1: System energy balance.

The necessary sensors to allow for the calculation of a complete energy balance for the system part shown in Fig. 7.1 are given in Table 7.1.

Table 7.1: Sensor list for measuring the energy balance.

Heat:	<ul style="list-style-type: none"> all heat flows (Q) 	
Electricity:	<ul style="list-style-type: none"> $\sum (E1, E2, E10)$ $\sum (E3, E4)$ $\sum (E-HP, E5, E6)$ 	solar circuit storage circuit heat pump circuit
Climatic data	<ul style="list-style-type: none"> (global horizontal irradiation) global irradiation in collector plane (diffuse irradiation in collector plane) ambient temperature wind speed 	

7.1.4 Additional sensors for seasonal storage evaluation

As the innovative borehole thermal energy storage (BTES) is of major interest additional monitoring sensors are foreseen to enable for a more detailed evaluation of this component.

- temperature sensors in BTES connection in-/outlet pipes
- volume flow sensors in BTES connection in-/outlet pipes (can also be derived from heat meters Q3 and Q4, see Fig. 7.1)
- ground temperature sensors inside the storage volume (see Fig. 7.2)
- ground temperature sensors around the storage volume (see Fig. 7.2)
- heat flux sensors plus two assigned temperature sensors respectively in cover insulation (see Fig. 7.2)
- possibility to take samples of the cover insulation material

- possibility to take samples of ground water
- ground water level sensor

Fig. 7.2 shows the sensor positions in- and outside the storage volume. Four temperature sensor strings inside the storage volume will be established first and will also be used to estimate the direction of the ground water flow. One temperature sensor string outside the storage volume will then be placed in the direction of the identified ground water flow, if any.

The vertical distribution of the temperature sensors in and around the storage volume (Fig. 7.2) should take into account areas where increased temperature gradients are expected. These areas are (numbers in meters below ground surface):

- The surface 0 m (= bottom of insulation layer)
- The bottom area of the storage volume 45 m (= borehole depth)
- The natural ground water level. 52 m

The vertical distribution of the temperature sensors according to this is:

+0.5, 0, -1, -2, -3, -4, -5, -10, -15, -20, -25, -30, -35, -40, -45, -49, -50, -51, -52, -53, -54, -59 m

With: +: meters above insulation layer bottom
 -: meters below insulation layer bottom
 "0": level of insulation layer bottom

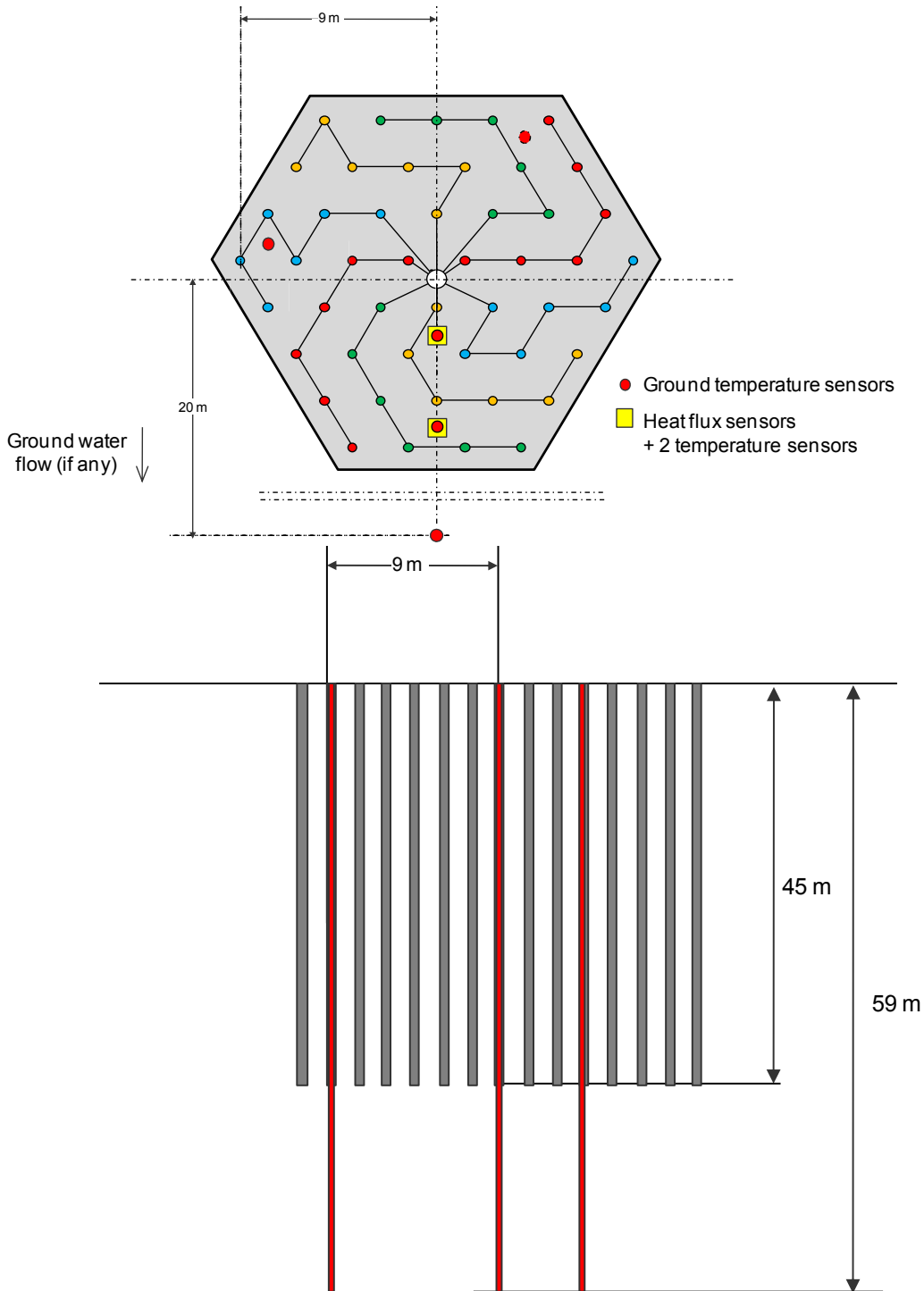

Fig. 7.2: Monitoring sensors in and around the BTES volume.

7.1.5 Additional sensors for operation control of the solar collector field

For the solar collector field a uniform flow distribution is vital to enable for a high collector field efficiency and high solar yields. This should be checked during commissioning and also regularly during normal operation. This is enabled in an easy way by the following sensors:

- Supply and return temperatures of selected solar collectors
- Supply and return temperatures of each solar collector row
- Pressure level in collector circuit

7.1.6 Sensor types

Recommendations for types of sensors to allow for accurate and stable measurements are as follows:

- Heat:
 - ultrasonic (US) or magnetic inductive heat meters (MI)
(except for water/glycol fluid → mechanical flow meter)
 - function independent from control - and communication system
 - maximum error for power rate 3%
 - output of the following data to the central measurement system:
 - accumulated heat
 - actual thermal power rate
 - actual flow rate
 - actual supply temperature
 - actual return temperature
- Temperature:
 - PT100 resistance temperature sensors
 - maximum error +/- 0.1 K
 - insertion length in pipes > 100 mm
 - installation against flow direction
 - insulation of casing
- Flow:
 - ultrasonic (US) or magnetic inductive (MI) flow meters⁵
 - maximum error 2% within relevant range of flow rates during operation (usually high errors at low flow speed)
- Thermal losses:
 - heat flux sensors
 - maximum error 5%
 - resistant against high temperatures and humidity
- Solar irradiation:
 - pyranometers
 - maximum error 3%
- Electricity:
 - electricity meter
 - maximum error 0.2%

If thermal power rates or accumulated heat values are calculated manually outside the heat meters Table 7.2 gives recommendations for single sensors accuracies to reach a maximum error of 3% for the calculated power rate.

⁵ MI heat meters have a higher risk of measurement inaccuracies due to scaling effects compared to US heat meters.

		relative accuracy	with	value	unit	absolute accuracy
		[-]				[+/-]
Density	$\Delta\rho/\rho$	0.001	ρ	1000	kg/m ³	1.00
Volume flow	$\Delta(dV/dt)/(dV/dt)$	0.02	(dV/dt)	1.66	m ³ /h	0.03
Heat capacity	$\Delta c_p/c_p$	0.01	cp	4.18	kJ/(kgK)	0.04
Temperature difference	$\Delta\Delta T/\Delta T$	0.02	ΔT	7	°C	0.14
Power	$\Delta(dQ/dt)/(dQ/dt)$	0.030	dQ/dt	15	kW	0.45
Accuracy						
[+/-]						
Signal conditioning devices	The proposal is to use a Data Acquisition System with at least the same accuracy as the sensor					
Electric energy counter	$\Delta E_{el.}/E_{el.}$	0.002				
Pyranometer (solar irradiation)	$\Delta G/G$	0.03				

Table 7.2: Accuracy of monitoring equipment as proposed within IEA SHC Task 38.⁶

7.1.7 Recording of data

In general data recording can be done either with constant time steps or with varying time steps. When using varying time steps recording of data normally is activated event-driven for each sensor. This means if the value of a specific sensor changes data is recorded in small time steps, if values do not change no data is recorded.

For a data recording system with constant time steps the following time resolutions for the recording of data is recommended:

- If thermal power rates and accumulated heat values are calculated manually the minimum time resolution for the recording of the involved volume flow and temperature data should be not more than 1-2 minutes.
- If thermal power rates and accumulated heat are calculated by heat meters the time resolution for the recording of data should be not more than 5-10 minutes. If fast control effects have to be checked smaller time steps are helpful.
- Solar irradiation: same time step as for hydraulic circuit data.
- Temperatures in the BTES storage volume: 10-30 minutes.
- Temperatures outside the BTES storage volume and heat flux sensors: 30-60 minutes.

If mean values for data in hydraulic circuits are calculated they should be weighted by flow rate or by power rate. In this way data without informative value (e.g. temperature values in pipes without flow) is eliminated:

$$T_{mean} = \frac{\sum_i T_i \cdot \dot{V}_i}{\sum_i \dot{V}_i}$$

The data collection, processing and storage system has to be able to process and store the data with an accuracy and numerical resolution corresponding to the accuracy of the sensors. This means e.g. no nameable additional errors and losses of information should be caused by signal conditioning and data processing and storage.

For an evaluation of the data the data storage system should be able to export data of all and selected sensors for definable time periods into separate data files (ASCII or compatible to common spreadsheet software like e.g. Microsoft Excel).

⁶ Assunta Napolitano, Wolfram Sparber, Alex Thür, Pietro Finocchiaro, Bettina Nocke; Monitoring Procedure for Solar Cooling Systems, Report, IEA SHC Task 38, <http://iea-shc.org/task38>, 2011.

7.1.8 Evaluation programme

The measurement programme allows for the following evaluations:

- Evaluations on system level
- Evaluations on component level
- Optimisation of control strategy

7.1.9 Evaluations on system level

The main evaluations on system level comprise:

- System energy balances
- System efficiencies
- Primary energy ratios and –savings
- Fractions of heat producers
- Environmental aspects

For the comparison of the efficiency of different system concepts and parameter sets different characteristic numbers can be calculated. The definition of some of them is shown in the following.

$$\text{Solar fraction: } F_{Sol} = \frac{Q_{Load} - Q_{Aux}}{Q_{Load}} = \left(1 - \frac{Q_{Aux}}{Q_{Load}}\right)$$

Primary energy savings compared to a conventional reference system:

$$F_{Save,PE} = 1 - \frac{\sum_i \frac{Q_{Aux,i}}{\eta_{Aux,i}} * f_{PE,Aux,i} + \sum_i E_{el,i} * f_{PE,el}}{\sum_i \frac{Q_{Aux,ref,i}}{\eta_{Aux,ref,i}} * f_{PE,Aux,ref,i} + \sum_i E_{el,ref,i} * f_{PE,el}}$$

Q_{Load} :	heat supply to the DH network
Q_{Aux} :	auxiliary heat delivered to the system (by boilers, CHP, el. demand heat pump etc.)
E :	electricity demand for pumps etc.
η :	efficiency of heat production from fuel
f_{PE} :	primary energy factor of fuels

Further evaluations on system level are recommended for environmental effects, e.g. calculations on CO₂ savings etc.

7.1.10 Evaluations on component level

The evaluations on component level target on the following aspects:

- Component energy balances
- Component efficiencies
- Short-term behavior (temperatures, efficiencies etc.)

Referring to specific components this results in the following:

- Solar collectors
 - Solar collector field efficiency $\eta_{Coll} = \frac{G_{sol}}{Q_{Coll}}$
 - Specific solar collector gain
 - Mean supply / return temperatures
 - Stagnation hours

- Thermal energy storage (TES)

- Energy balance

- Storage efficiency

$$\eta_{TES} = \frac{Q_{TES,out} + dQ_{TES}}{Q_{TES,in}}$$

- No. of storage cycles

$$N_{cyc} = \frac{Q_{TES,out}}{Q_{TES,max}}$$

($Q_{TES,max}$: total heat capacity of the storage)

- Thermal losses

- Mean supply / return temperatures

- Temperature development inside / outside storage volume

- Heat flux through insulation / walls

- Heat pump

- COP

- Temperature levels in evaporator / condenser

- Performance maps (COP and thermal power for different working conditions)

- Operation time

7.1.11 Optimisation of control strategy

The analysis of the evaluations on system and component level described above can give information about possible optimisation potentials. In this respect the following subjects are in the focus of the analysis:

- Component heat contributions
- Component efficiencies
- Component operation time and –periods
- Temperature developments
- Technical and economical boundary conditions

7.2 Monitoring results

Monitoring data for evaluation was available from January 2012 until beginning of March 2013. The new solar collector area went into operation in April 2012, and the BTES was charged for the first time in May 2012.

7.2.1 System heat balance

Fig. 7.3 shows the monthly heat balance of the overall system. In 2012 about 40 GWh of heat were delivered to the district heating (DH) network. 16.5 % of the produced heat was delivered by the solar collectors. Another 20 % were produced as surplus heat from the two gas engines, 57 % were produced by two gas boilers. The electrical boiler was responsible of 6.5 % for the heat delivery.

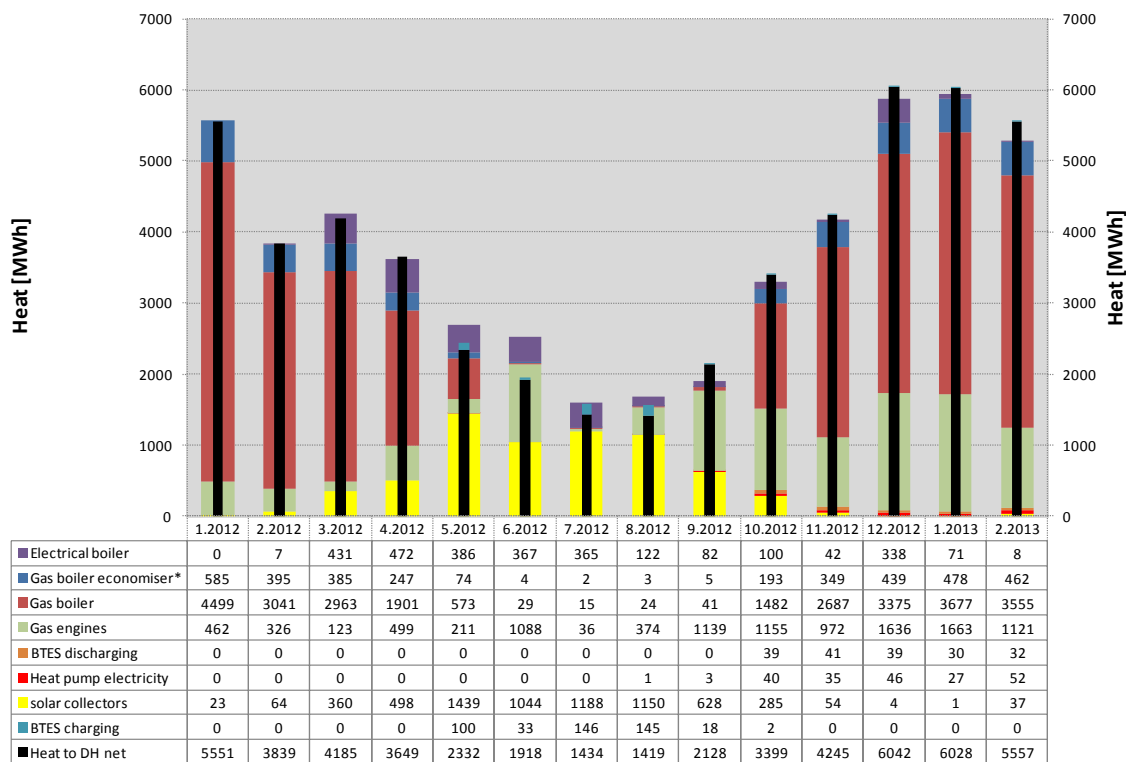

Fig. 7.3: System heat balance (numbers in MWh).
 (*: not monitored, estimated from gas boiler heat production.)

In the summer months July and August the solar collectors were able to cover more than 80 % of the heat load, additionally 290 MWh of solar heat were charged into the borehole thermal energy storage (BTES) in these two months.

7.2.2 The borehole thermal energy storage

Fig. 7.4 shows the heat balance of the BTES since it was charged for the first time. In total 444 MWh have been charged into the ground between May and October 2012, 120 MWh have been discharged in winter 2012 and another 43 MWh in January and February 2013. Fig. 7.4 also shows the accumulated heat content. This is the sum of charged and discharged heat amounts not taking into consideration any heat losses of the storage. The heat losses cannot be measured directly as there is no accessible and well defined surface of the storage volume.

From simulations and also from operational experience of other comparable projects it is known that BTES have a start-up phase of about 3-5 years. In this time the ground around the storage volume is heated up by the thermal losses of the storage. Hence, normal operation with calculated storage efficiencies and storage temperatures will not be reached in the first years of operation.

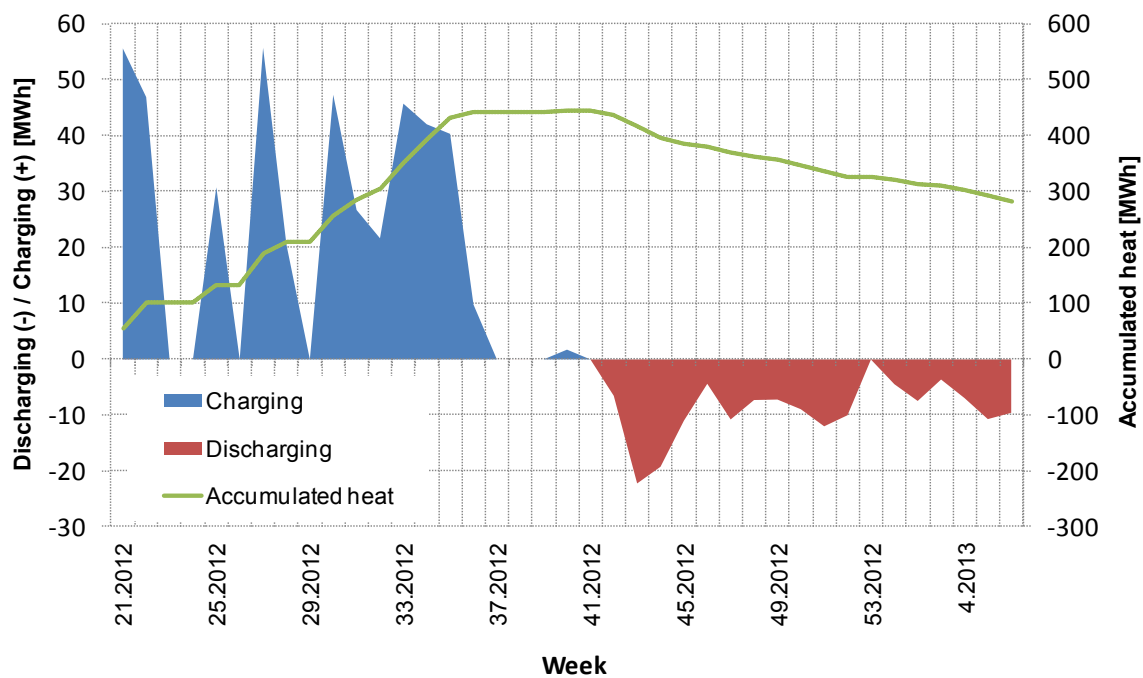

Fig. 7.4: Weekly heat balance of BTES.

As described in section 7.1 a number of temperature sensors were installed in the ground between and also around the borehole heat exchangers to be able to evaluate the development of the ground temperatures. Fig. 7.5 shows the horizontal positions and labels of the temperature sensors. In the Figures 7.6 to 7.9 the development of the ground temperatures can be observed. Some of the temperature sensors are not shown as there was no data available.

As can be seen in Figures 7.6 to 7.9 the undisturbed ground temperatures were about 8 °C before the charging of the BTES started end of May 2012. The charging took place in five major steps until end of September where the maximum temperatures in the storage reached almost 60 °C in the horizontal center of the storage. They occurred below the insulation layer (see Fig. 7.6). From beginning of September until mid of October there was a phase without any charging and discharging processes. Depending on the location the temperatures dropped between 5 and 10 K in this time period. This is due to equalization effects that took place inside the storage volume and also to the surrounding ground. After this phase a more or less continuous discharging phase followed.

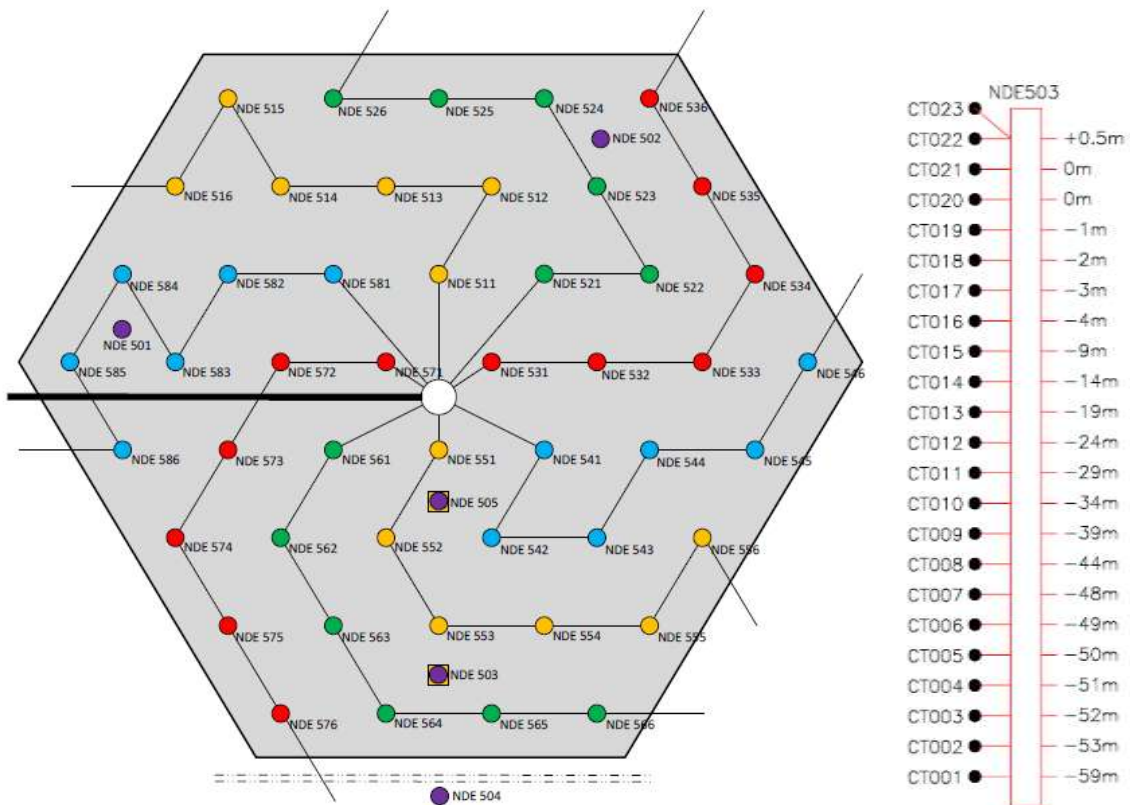

Fig. 7.5: Horizontal positions of vertical temperature sensors lances NDE 501 to NDE 505 (violet) in and around the BTES volume, and alignment of sensor labels and sensor positions below ground surface (the insulation layer is located between +0.5 m and 0 m).

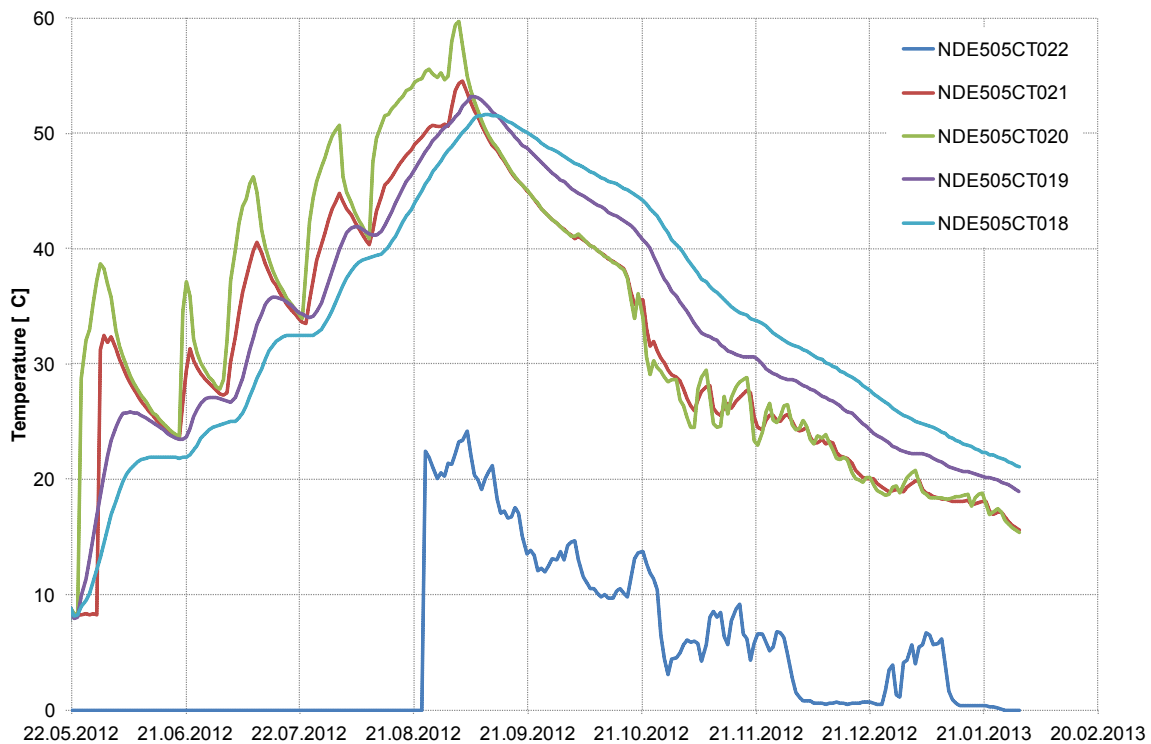

Fig. 7.6: Ground temperature development at the central position NDE 505.

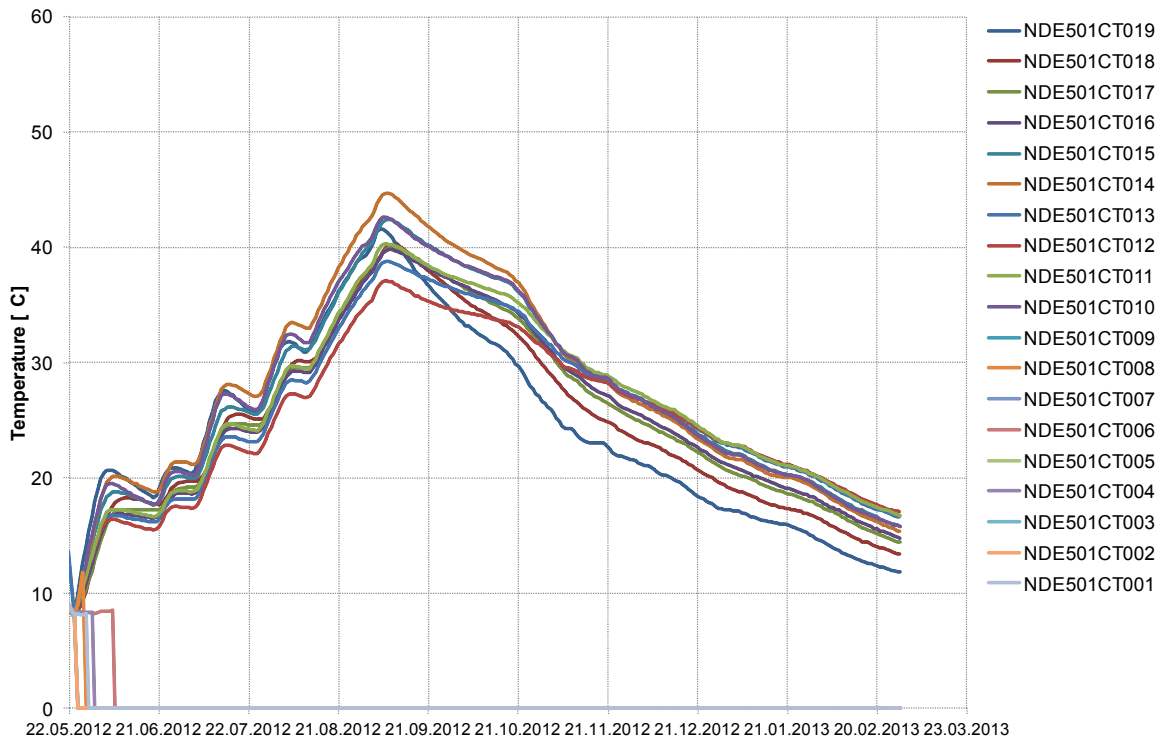

Fig. 7.7: Ground temperature development at position NDE 501.

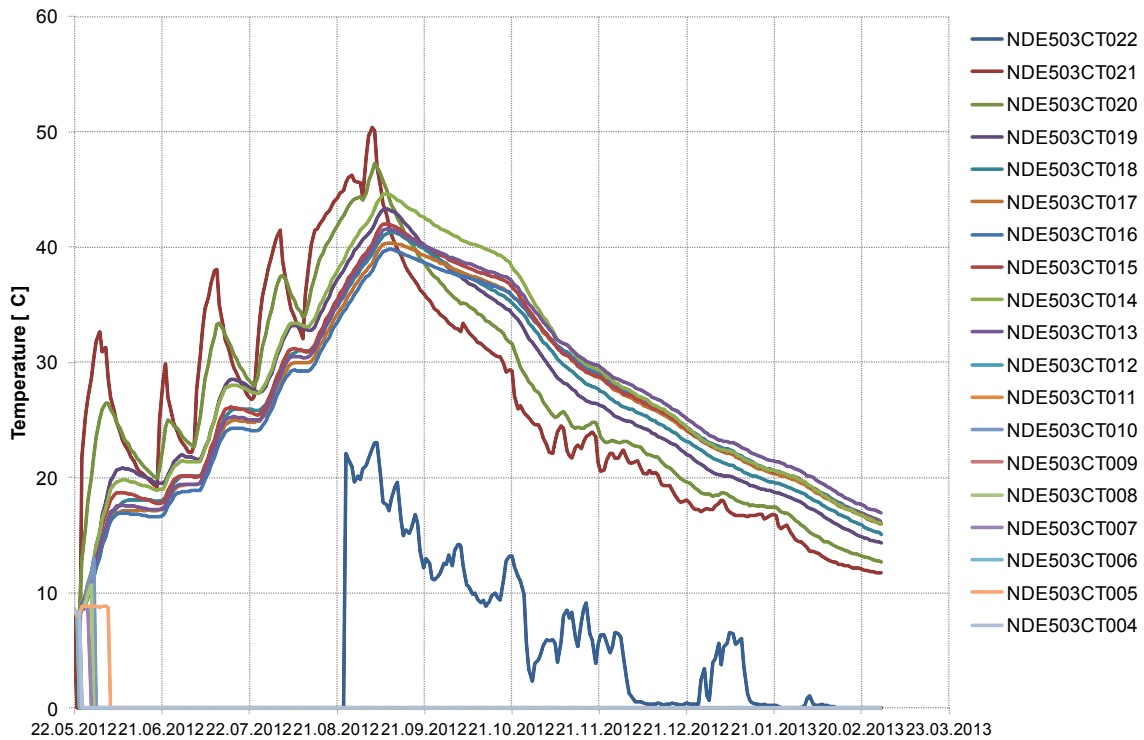

Fig. 7.8: Ground temperature development at position NDE 503.

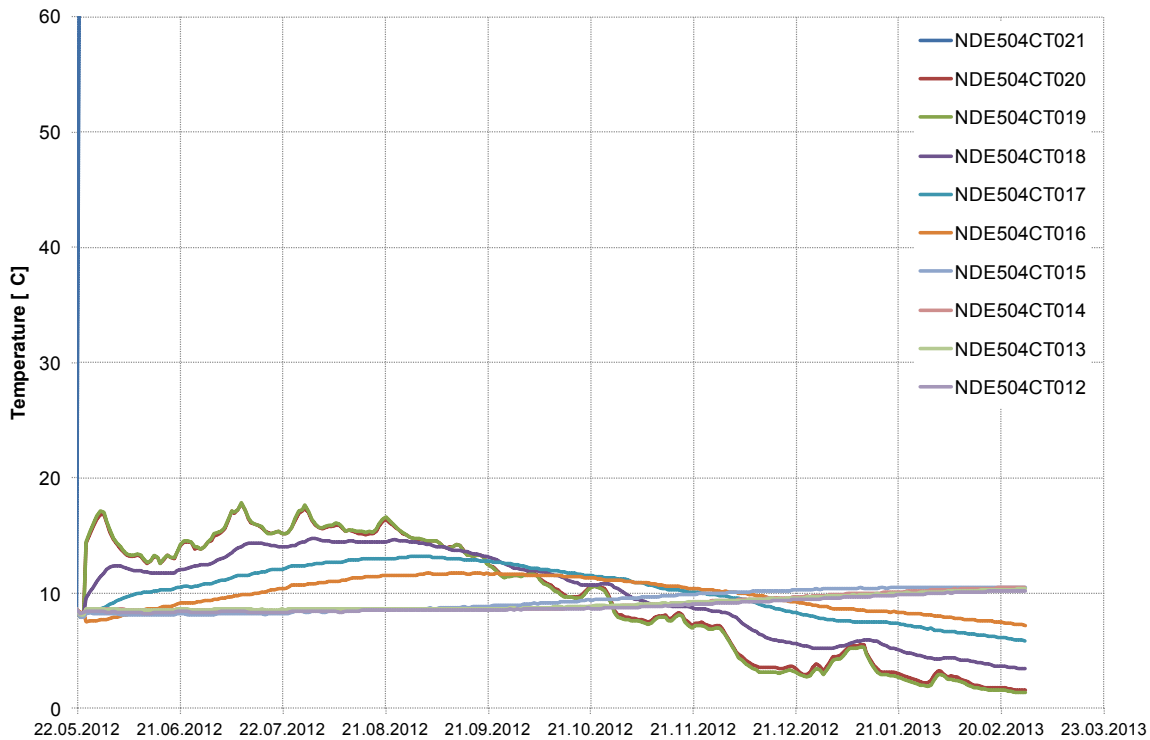

Fig. 7.9: Ground temperature development at position NDE 504, outside the storage volume.

Fig. 7.9 shows the ground temperatures in a distance of 20 m from the center of the BTES and about 10 m outside the storage volume. So far the observed temperature variations in the upper sensors are rather induced by seasonal effects from the ground surface than by thermal losses from the storage.

Fig. 7.10 illustrates the temperature distribution in different depths below the ground surface inside and outside the storage volume on a monthly basis. The temperatures at the locations NDE 501 and NDE 503 show a certain temperature variation at different depths. This can be induced e.g. by different ground properties, or by a certain ground water movement in specific areas. More specific conclusions can first be made after a longer observation of the temperature developments.

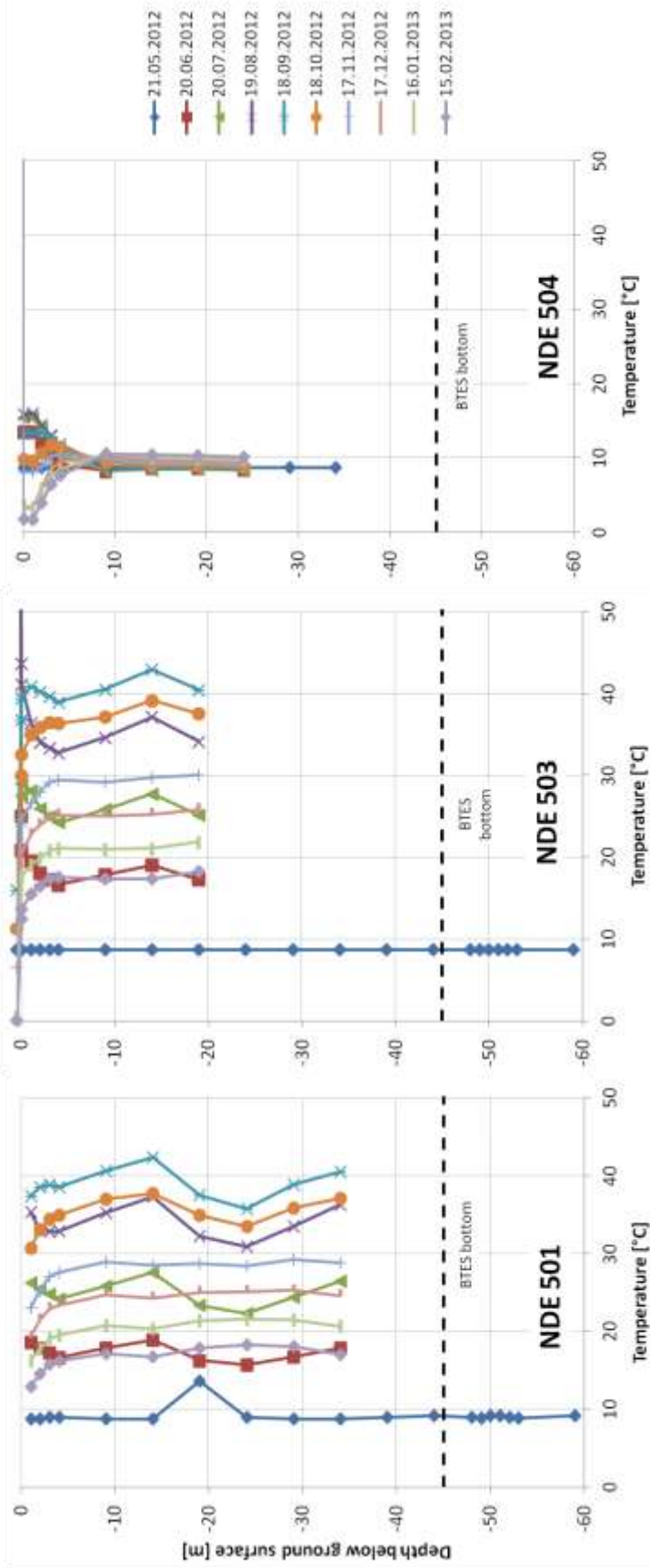

Fig. 7.10: Monthly ground temperatures in and around the BTES storage volume.

In Fig. 7.11 the temperatures, flow rates and power rates of the main charging periods are shown. The BTES was charged with supply temperatures of about 80 °C. In the beginning charging of heat was possible with more than 600 kW. When the temperatures in the storage volume increase the charging power rates decrease as the temperature differences between supply and return line also decrease.

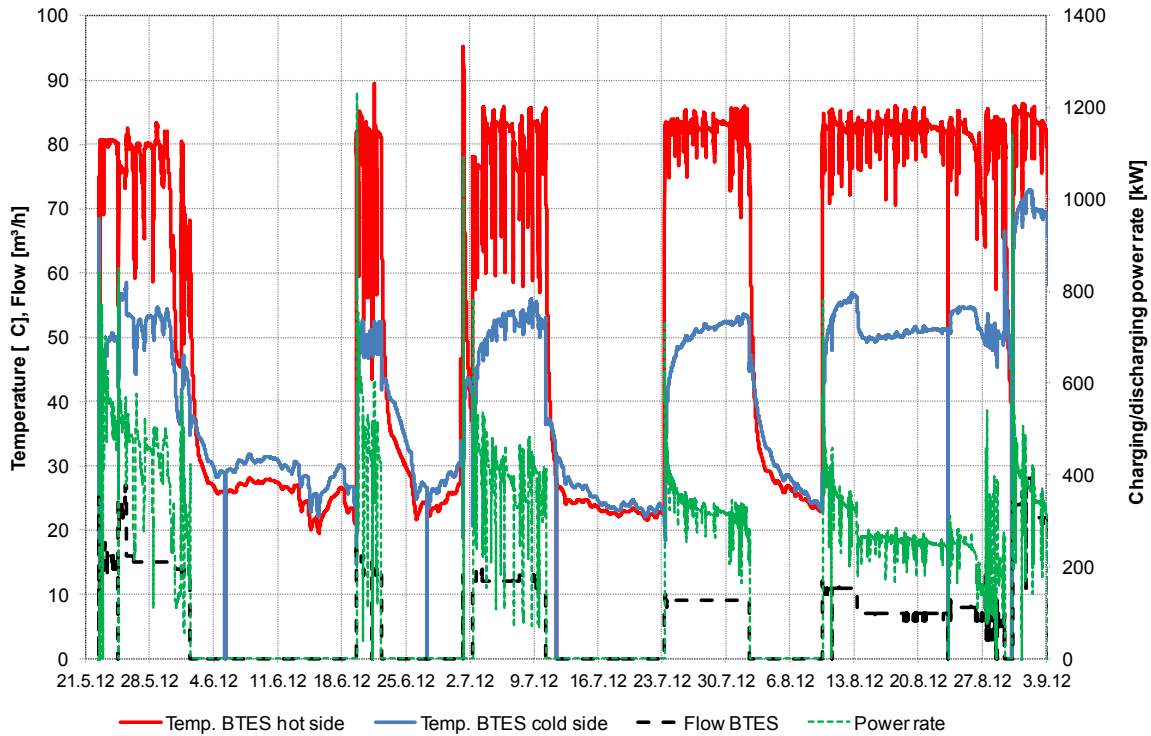

Fig. 7.11: BTES charging periods from May to September 2012.

7.2.3 Solar collector fields

Fig. 7.12 shows the monthly heat production of the existing (8,000 m²) and the new (10,600 m²) solar collector field. According to these numbers the yearly specific heat gain was 406 kWh/m² solar collector area for the existing field. The new field was not in operation for the whole year. When assuming a constant ratio of heat production between the existing and the new field for the entire year the specific heat gain for the new field can be estimated to approx. 435 kWh/m². The yearly efficiency of the solar collector circuit of the existing solar collector field was 36 %.

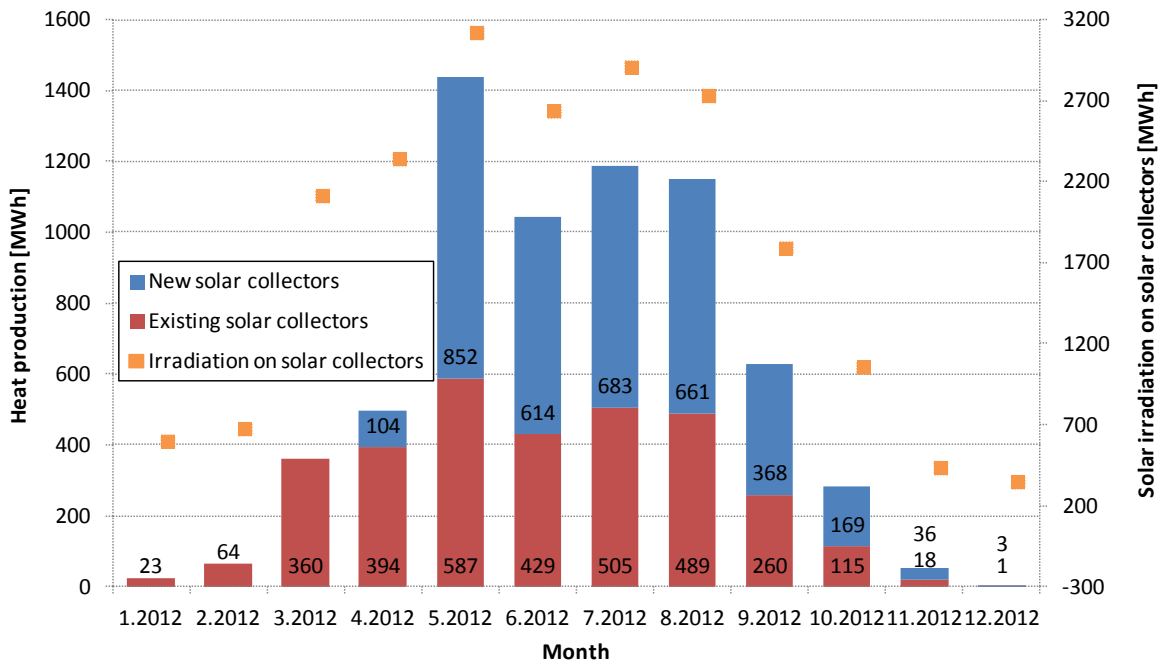

Fig. 7.12: Monthly heat production of solar collectors in 2012.

7.2.4 Heat pump

Fig. 7.13 shows the monthly heat balances and the corresponding COP's of the heat pump. The overall COP for the whole monitoring period is 2.9.

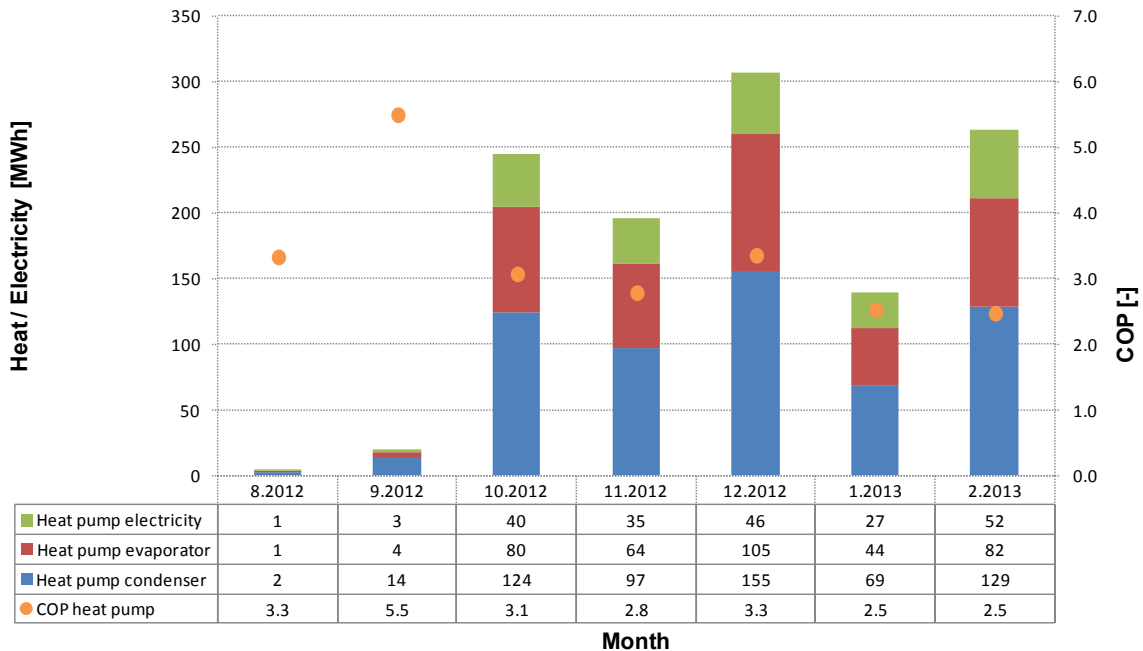

Fig. 7.13: Heat balance and COP of the heat pump (numbers in MWh).

Fig. 7.14 exemplarily shows a one week operation period in February 2013. The heat pump has daily operation periods of 6 to 8 hours and delivers heat at 80 °C to the DH system by cooling water coming from the BTES from below 20 °C to below 10 °C.

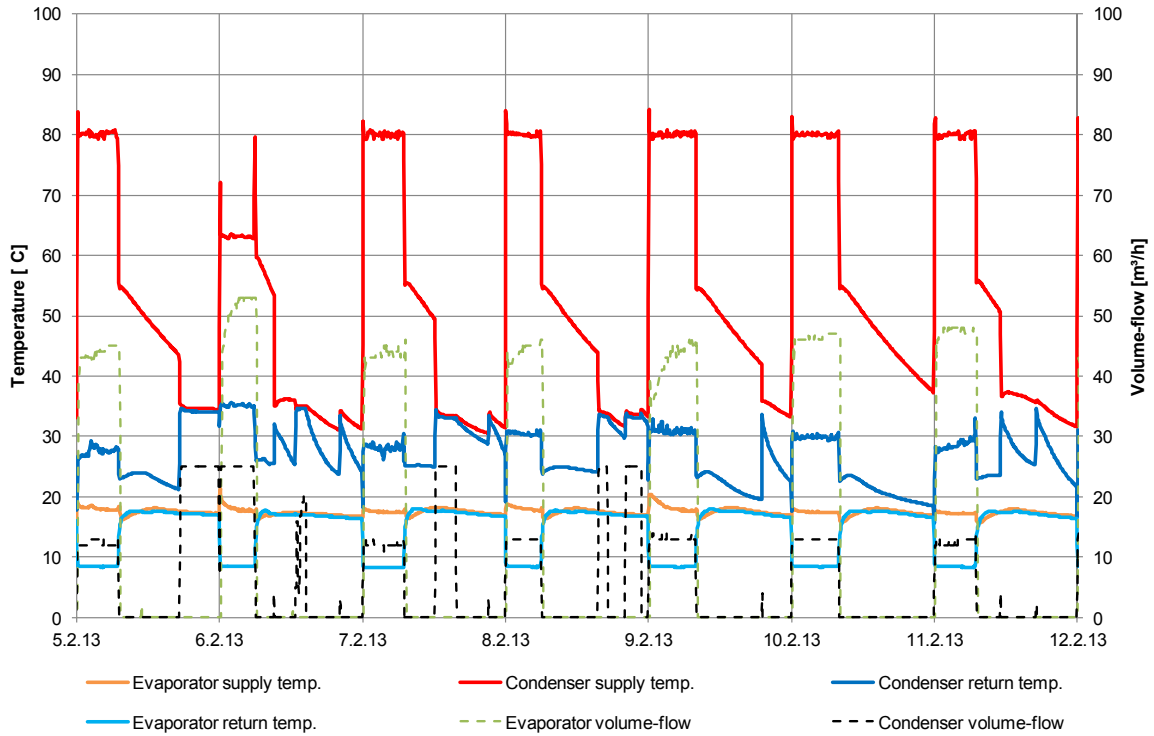

Fig. 7.14: Heat pump operation in February 2013.

8 Control strategy

8.1 The overall control strategy

The energy production plant in Brædstrup includes the following units:

1. Two natural gas fired engines (8.2 MW_{heat})
2. Natural gas boiler 1.
3. Natural gas boiler 3.
4. Accumulation tank 1 (2,000 m³)
5. Accumulation tank 2 (5,000 m³)
6. Solar plant 1 (8,000 m²)
7. Solar plant 2 (10,600 m²)
8. Borehole storage (~5,000 m³ water equivalent)
9. Electrical driven heat pump (1.2 MW_{heat})
10. Electrical boiler (10 MW)

Items 5 plus 7-10 are established in the present project. System diagram can be seen in Annex 6. The control strategy shall minimize the production cost (and maximize income from the electricity market) making the produced heat as cheap as possible, and it has to be as simple as possible making it easy to find failures and optimize the system.

Therefore the units are as autonomous as possible (can be controlled independently).

As a main rule the heat production cost is a function of the natural gas price and the electricity price at the spot market. This is illustrated in Fig. 8.1.

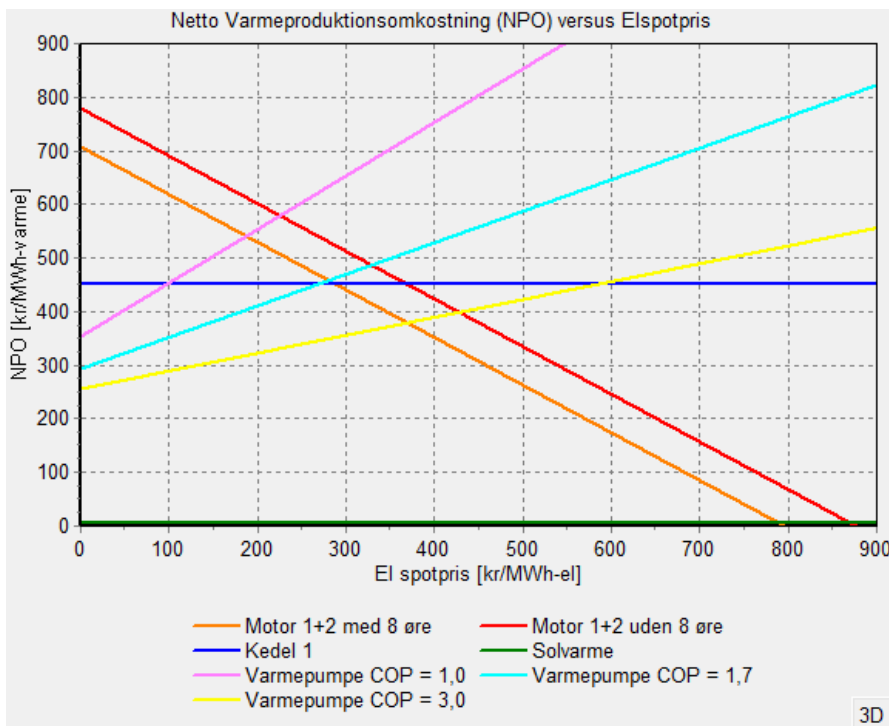

Fig. 8.1: Heat production cost as a function of the electricity spot price with a natural gas price of 2.50 DKK/Nm³.

But this can be overruled by high prices in other electricity markets (see section 8.2).

From Fig. 8.1 it can be seen that solar heat ("Solvarme") has first priority until an electricity spot price of more than 800 DKK/MWh. The system efficiency of the heat pump ("Varmepumpe") is app. 1.7, so heat pumps and engines ("Motor") are the next priorities depending on the electricity price.

Last priorities are the gas boilers ("Kedel") and the electrical boiler ("COP = 1.0", starting when electricity prices are below 100 DKK/MWh).

The units in the present project are controlled as follows:

The main principle is that the units produce to the accumulation tanks. The **accumulation tanks** have two "modes":

- "Winter mode", where the district heating return is added between the two serial connected tanks. The large tank will then be "warm" and the small tank will be "cold".
- "Summer mode", where the district heating return is added in the bottom of the small tank. Both tanks are "warm" in this mode.

Winter mode shall be used as much as possible.

In Winter mode the small tank is a cold storage used to discharge the borehole storage and to maximize solar production.

Change to summer mode occurs if the large tank is "filled".

The **heat pump** runs like the engines in 3 load modes:

0. Stand-by
1. Full load
2. Partial load (by primarily regulation, see section 8.2)

The load mode is decided by the electricity market. In load mode 2 the load is controlled by an external signal (frequency regulation). This has not been implemented yet.

In the most simple situation the heat pump will run in mode 1, when the electricity price is below a calculated value (for instance 250 DKK/MWh as shown in Fig. 8.1). The value has to be recalculated for changing gas prices and to ensure an amount of running hours for the heat pump, which empties the borehole storage.

As an example 450 running hours will empty the borehole storage for 300 MWh if the cooling capacity is 0.67 MW.

The production temperature from the heat pump will be kept as low as possible by shunting with hot water from the top of the large accumulation tank.

The **borehole storage** has 3 load modes:

0. Stand-by (no flow)
1. Charging
2. Discharging

Charging will start, when the accumulation capacity in the large tank is more than 50 % utilized. Water is taken from middle of the large tank to the center of the borehole storage and returned to the connection between the tanks.

At discharging the flow direction in the borehole storage and in the transmission pipe is reversed, and cold water is taken from the bottom of the small tank and returned to the connection between the tanks.

Normally the flow is fixed (100 %), but it will be reduced to maintain a minimum temperature difference between forward and return. When the temperature difference is too small (for instance 2 K) discharging will stop.

Solar plant 2 (10,600 m²) has 6 modes:

0. Stand-by
1. Idle running
2. Production
3. Shut down
4. Frost protection
5. Heat blow off

The possibilities for shift between the modes can be seen in Fig. 8.2.

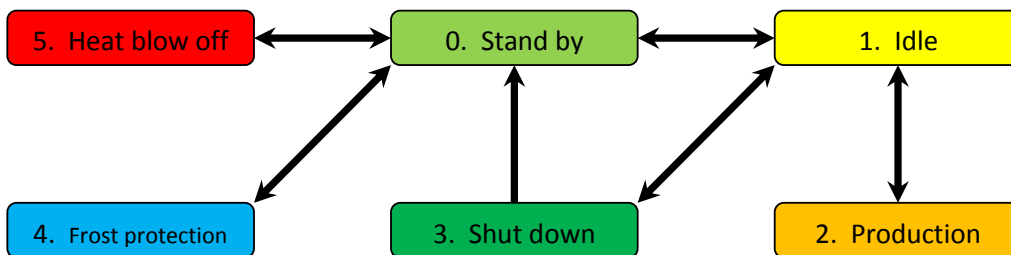

Fig. 8.2: Possibly shift of modes in solar plant 2.

Mode 1 is used to warm up the solar circuit when solar radiation is too low for production.

Mode 2 is used to load the accumulation tank.

Mode 3 is used when the solar plant is closed for the night (the solar circuit will be cooled as much as possible).

Mode 4 is used below -15° C. There is 30 % glycol in the solar circuit liquid. With temperatures below -15° C heat is added by taking heat from the top of the small accumulation tanks.

Mode 5 is used if next days production cannot be stored in the accumulation tanks.

The **electricity boiler** is runned as the engines in 3 load modes:

0. Stand-by
1. Full load
2. Partial load (by frequency regulation)

In the most simple situation the electricity boiler is runned in mode 1 and starting when the electricity price is below a calculated value (for instance 100 DKK/MWh as shown in Fig. 8.1).

8.2 The Danish electricity market

Production Strategy

To ensure as cheap heating prices as possible is a well-defined production strategy necessary. Therefore we must ensure that the cheapest production technology is in play at any time.

The solar system

The first priority is of course solar heat and its application for direct heating to the city of Brædstrup. If the solar plant producing more energy than used, the energy will be stored in the steel tanks and then afterwards in the borehole storage system.

The generator-systems - the spot market

These produce both electricity and heat and are - in terms of planning - profitability compared to the alternatives: The natural gas boilers and the electric boiler. Therefore the economic operation of the motor systems is entirely dependent on electricity prices in the spot market (Nord Pool) and the natural gas prices.

Therefore, it is necessary to calculate the so-called "marginal production cost" for each day. The "marginal production cost" is defined as the minimum production price for the electricity generated and delivered to the spot market, which is needed so the motor systems heat can compete with the price of the produced heat for the alternatives.

The generator-system – the regulate and the available markets

Besides acting in the spot market, Brædstrup Total Energy is strongly committed to the regulate and available markets. For every hour of operation for each day the operation must be assessed whether the most economically either to be engaged in the regulate and available markets or in the spot market.

When speaking of regulate and available markets, it is about the primary (frequency control) and manual regulation markets.

The electric boiler (10 MW)

As in the case of the generating units the electric boiler is used in both the regulating and the available markets and in the spot market. And as for generating-systems it is calculated for every hour of operation for each day of operation for the most economically either to be engaged in and regulate the available markets or the spot market. Again the natural gas boilers are serving as the reference.

The heat pump (0.45 MW electricity)

The heat pump is used primarily to "empty" the borehole storage of heat. This ensures a hot top and a cold bottom of the steel-tanks and boosts the temperature up from the borehole-storage.

To ensure the most economically optimal operation of the heat pump it must also participate in the electricity market and runs when the spot prices are as low as possible.

The heat pump cannot be used for primary regulation (frequency control) but in principle it can be used as up-and down-regulation in the manual regulating market. However the regulation capacity is limited to the rated power (0.45 MW electricity)!

The natural gas boilers

If it is not profitable to use the above production technologies - or their production capacity is not sufficient in the cold periods, the natural gas boilers are used to produce the necessary heat.

Heat production prizes as a funktion of el-prizes
(Prize of natual gas: 2,82 Dkk/m3)

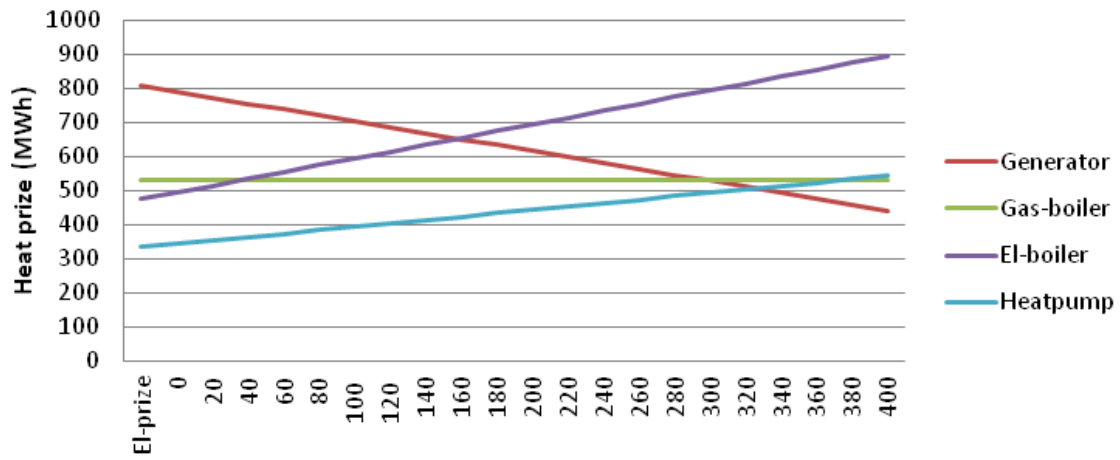

9 Economy

Brødstrup Totalenergianlæg had an initial budget for the new production plant. Including support from ForskEi the total budget was expected to be 21.7 mio. DKK (see Table 9.1). But unforeseen extra costs caused that the realized costs were app. 5.75 mio DKK higher. The most important extra costs were:

- The museum found interesting holes from houses. Investigation costs 486,000 DKK instead of 50,000 DKK.
- Soil had to be changed under the accumulation tank 626,000 DKK instead of 500,000 DKK.
- Punctual foundation had to be changed 1,533,000 DKK instead of 655,000 DKK.
- Drilling and grouting in borehole storage went from 670,000 DKK to 1,113,000 DKK because of complicated drilling and extra grouting.
- Piping of the secondary side went from 500,000 DKK to 1,175,000 DKK after detailed design.
- Lid in the borehole storage went from 300,000 DKK to 843,000 DKK after detailed design.
- Control system and monitoring went from 1,844,000 DKK to 3,322,000 DKK after detailed design.

Because of the extra costs Brødstrup Totalenergianlæg got extra support from ForskEi (600,000 DKK) and EUDP (1,600,000 DKK).

The costs can be seen in Table 9.1 below

Project "Boreholes in Brædstrup"

Budget and realized costs

(amount in 1,000 DKK)

As per 31.12.2012

Part projects	Budget	Realized
Solar plant, transmission pipe and accumulation tank connection	19.422	20.348
Piping of the secondary side	500	1175
Punctual foundation	655	1533
Drilling and pipes, borehole storage	670	1113
Lid, borehole storage	300	843
Test drilling and laboratory	175	279
Aarsleff	65	65
Control system	1.844	3322
Building	640	971
Foundation of building	200	0
Heat pump	750	750
Drawings, pipes in building	48	48
Water to accumulation tank	30	0
Foundation, accumulation tank	500	626
Geological studies tank	100	88
Land	1.100	1790
Plants	150	111
Measuring equipment	500	278
Horsens museum	50	486
Other assistance		653
Sum	27.699	0
Miscellaneous	1.000	
Total excl. support	28.699	34.479
Support	6.955	6.955
Total incl. support	21.744	27.524

Electric boiler		
Electric boiler	4.800	4.800
Connection costs	240	144
Total - electric boiler	5.040	4.944

Total for the project incl. support	26.784	32.468
--	---------------	---------------

Table 9.1: Budget and realized prices for the project

For the extra 5.75 mio. DKK it has to be mentioned that Brædstrup Totalenergianlæg got 10,600 m² solar collectors instead of 8,000 m² and a 5,500 m³ accumulation tank instead of 2,000 m³.

The costs for the borehole storage are:

Drilling 1.113 mio. DKK

Lid 0.843 mio. DKK

Total 1.956 mio. DKK

or app. 103 DKK/m³ (13.8 €/m³)

Labour costs are not totally included since Brædstrup Totalenergianlæg did themselves most of the work implementing the lid and these working hours are not fully included in the realized costs.

10 Dissemination

Project "Boreholes in Brædstrup" has been shrouded in a massive interest. There have been a large number of visitors, both of national and international character. These include fellow companies and their boards, representatives from municipalities, industry associations, interest groups and politicians – latest by Interior Minister Margrethe Vestager.

Especially the borehole storage system, which is the first of its kind in Denmark, is exposed to very great interest.

There has been informed about the project in several forums. These include lectures for municipalities and meetings for Danish and for foreign district heating companies and interest groups.

Under the auspices of the EU projects SDHplus and IEA SHC Task 45 - Large Systems has been organized sessions and workshops in Brædstrup where the project is presented and visited.

Likewise, the project has been a part of the annual recurring "international summer school" where international students learn about the Danish models for energy production and distribution - including renewable energy.

The project is used regularly in education at institutions of higher education. These include Aarhus School of Marine and Technical Engineering, University of Aarhus and VIA University in Horsens.

Not least, the project is a catalyst and motivator for energy planning in particular Horsens and Hedensted municipality and Region Midtjylland.

There has been a great personal interest to visit the plant. Visitors to the site can through posters in a dedicated pavillon gain an insight into the construction of the plant with a description of the individual elements of the concept.

Similarly, in the pavillon, a "pedagogical understandable production barometer" is mounted and shows the instantaneous heat production from both the 2007-plant and the new plant – that means the production from a total of 18,612 m² of solar collectors. The posters can be seen as Annex 8. Also an English version of the poster diagram is made (Annex 9).

The project is presented on the website www.solvarmedata.dk where the actual among other production and historical data can be seen.

Likewise, the project detailed is set out on the Braedstrup District Heating's website www.braedstrup-fjernvarme.dk where incidentally the number of visitors is quite satisfactory.

This point to a continuous interest in the project - even after this is completed, and thus has passed the operational phase!

Some of the external dissemination activities are listed below:

- Article in *Ingeniøren* 17.12.2009
- Article in *El & Energi* (spring 2010)
- Article in *Fjernvarmen* No. 2 2010
- Presentation at Geoteknisk Forenings yearly meeting in Odense, January 2011
- Presentation at Danish District Heating Associations 8 regional meetings, Spring 2011
- Article in *Ingeniøren* February 25th, 2011
- Presentation at ATV's yearly meeting March 8.-9., 2011
- Presentation at IRES, Nov. 28.-30., 2011 in Berlin
- Presentation for VE-net, December 15., 2011 in Aarhus
- Presentation at Intersolar Europe Conference, June 11.-14., 2012 in München
- Presentation at EUROSUN 2012, September 18.-20., 2012 in Rijeka
- Presentation in Kiel, October 23., 2012
- Presentation at Half-year meeting in 4DH-WP2, March 11., 2013 in Aarhus
- Presentations at EGC 2013 (European Geothermal Congress) in Pisa
- Article in *Sonne, Wind & Wärme* 04/2013

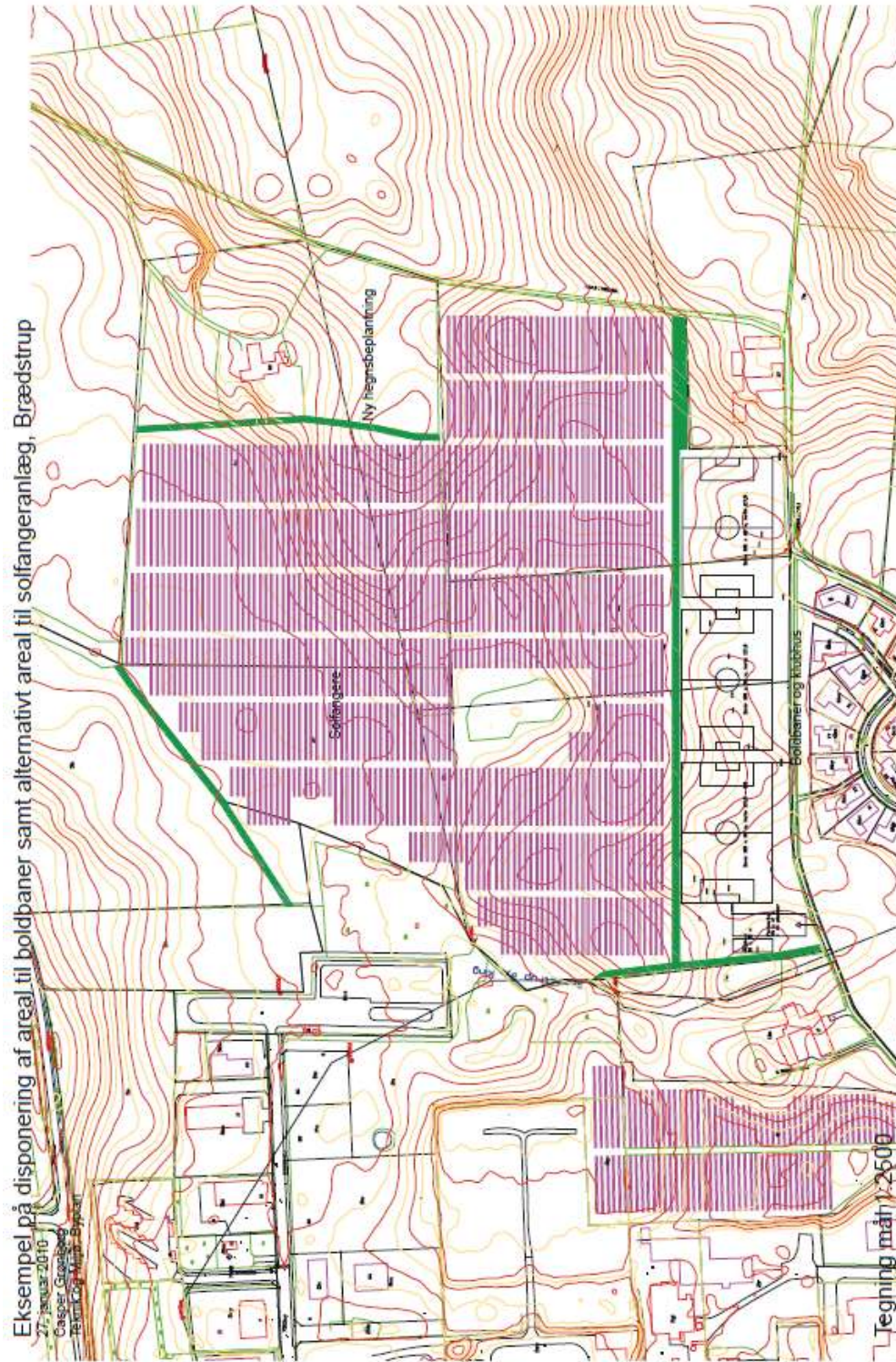

ANNEX 3

Brødstrup. Fjernvarmevej 2
Borehole Thermal Energy Storage (BTES)
Geological og geotechnical site investigation

GEO project no. 32926
Report 2, 2010-06-22

Summary

Brødstrup Totalenergianlæg A/S is planning an expansion of the existing solar heat area. The expansion necessitates an energy storage, which is planned to be established by a pilot Borehole Thermal Energy Storage (BTES) of a equivalent water volume of approx. 8.000 m³.

GEO has conducted a site investigation, which comprises 8 CPT-soundings, 2 borings, 1 thermal response test in a boring and laboratory tests.

The investigations shows, that the soil consists of varying layers of clay till, sand and silt. The groundwater table is in approx. 50 meters depth. The average thermal conductivity down to 45 meter is measured to 1.42 W/(m·K). The average heat capacity is 1.8 – 2.0 MJ/(m³K).

The performed site investigation has shown that the clay till is relatively well suited for energy storage, but the encountered layers of dry sand are less suited. There is no flow of groundwater down to approx. 50 meters depth.

The upper 2 - 3 meters of soil are relatively soft, but the layers below are generally stiff/dense and very stiff/very dense. These conditions shall be taken into account in the planning of drilling method and choice of equipment for the energy boreholes.

GEO
Sødalsparken 12
8220 Brabrand
Tel: +45 8627 3111
Fax: +45 8627 6706
geo@geo.dk
www.geo.dk
CVR-no: 59781812

Prepared for
Brødstrup Totalenergianlæg A/S
Fjernvarmevej 2
8740 Brødstrup

Prepared by Jan Dannemand Andersen,
9879 9387, jda@geo.dk

Controlled by Morten Kjærgaard,
8741 2355, mok@geo.dk

Contents

1	Background	3
2	Investigations	3
	2.1 CPT-soundings	3
	2.2 Borings	4
	2.2.1 Boring 3	4
	2.2.2 Boring 4	4
	2.3 Thermal response test.....	5
	2.4 Thermal laboratory tests.....	5
3	Results.....	6
	3.1 Terrain.....	6
	3.2 Soil strata	6
	3.3 Groundwater.....	6
	3.4 Thermal measurements	7
4	Evaluation	9
	4.1 Generally suitability	9
	4.2 Thermal properties	10

Enclosures

2.1 – 2.8	CPT profiles, CPT nos. 1 - 8
2.9 – 2.10	Boring profiles, boring no. 3 and 4
2.11	Grain size distribution
2.12	Photos
2.13	Site plan

Appendix

2.A	Bericht zum Geothermal Response Test
-----	--------------------------------------

1 Background

Brædstrup Totalenergianlæg A/S is planning an expansion of the existing solar heat area from 8.000 m² to 16.000 m². The expansion necessitates an energy storage, which is planned to be established by a pilot Borehole Thermal Energy Storage (BTES). The storage volume will have a water equivalent of approx. 8.000 m³. In addition a 2.000 m³ buffertank has to be raised.

The position of the BTES is not defined, as the positioning depends on the possibilities of land acquirement, ground conditions, etc.

2 Investigations

2.1 CPT-soundings

The site investigation has initially included CPT-soundings (Cone Penetration Test) in 8 positions as shown in enclosure 2.13. The positions are chosen by Brædstrup Totalenergianlæg.

The positioning and leveling of the CPTs were carried by GEO out using GPS equipment in system 34J/DVR90.

The CPTs were executed according to ISSMGE, Technical Committee 16, 1999 with continued penetration and logging of data. Tip resistance q_c and sleeve friction f_s were recorded during each test. The cones used were Van den Berg Icones (60-degree type with cross sectional areas of 10 cm²).

The CPTs was penetrated unto 9.3 to 20.6 meters depth, where further penetration was restricted by the maximum thrust of the CPT-rig of approx. 9 tonnes.

The results of the CPTs are presented in enclosures 2.1 to 2.8, where the following data are presented in 4 columns for each test:

- Column 1 shows the cone resistance q_c as two curves; one corresponds to a low range scale (0 - 5 MPa) and one to a high range scale (0 - 50 MPa).
- Column 2 shows the sleeve friction f_s .
- Column 3 shows the friction ratio $R_f = (f_s/q_c) \cdot 100$ %.
- Column 4 shows an interpretation of the penetrated soil, using the results of the borings.

In sands the relative density is evaluated using the following graduation:

$0 < q_c \leq 2.5 \text{ MPa}$: Very loose
$2.5 < q_c \leq 2.5 \text{ MPa}$: Loose
$5 < q_c \leq 10 \text{ MPa}$: Medium dense
$10 < q_c \leq 20 \text{ MPa}$: Dense
$20 < q_c$: Very dense

In clay/silt the stiffness is evaluated in the terms soft, firm, stiff and very stiff, using the formula for the undrained shear strength $c_u \approx q_c/N_k$, where N_k for the evaluated soils can be chosen to $N_k = \text{approx. } 10$.

2.2 Borings

2.2.1 Boring 3

Based on the results of the CPTs it was decided to perform a boring adjacent to CPT 3.

Boring 3 has been carried out as Ø6" cased boring unto 25 meters depth. Soil layers were registered and remoulded and undisturbed samples have been extracted. During drilling field vane shear tests were carried out in the deeper cohesive layers.

Upon completion three 25 mm PVC-standpipes were installed in resp. depth of 7.5, 19 and 25 meters depth. The bore hole was filled with quartz sand (0.7 – 1.2 mm grains) and bentonite pellets (Mikolit B) between standpipes and near ground level.

All soil samples have been geologically described by an engineering geologist in accordance with the Danish Geotechnical Society Bulletin 1, "A guide to engineering geological soil description". Lithological descriptions include an evaluation of depositional environment and age. For selected samples the natural moisture content w and gravity weight γ were measured.

The boring profile with all observations and measurements are shown in enclosure 2.9. Legends and abbreviations are shown in the enclosed GEO-Standard.

2.2.2 Boring 4

After completion of boring 3 it was decided that the storage presumably was to be placed in the area of CPT 1 – 5. In order to investigate the soil and groundwater conditions in deeper strata a boring has been executed adjacent to CPT 4.

Boring 4 has been carried out as Ø10" cased boring unto 51 meters depth, where groundwater was encountered. Soil layers were registered and remoulded and undisturbed samples have been extracted. During drilling a few field vane shear tests and SPTs (Standard Penetration Tests) were carried out. At the bottom of the bore hole a Ø63 mm PEH-standpipe was installed, supplemented by a Ø25 mm PVC-standpipe at 7,5

meters depth. In the bore hole above a thermal pipe consisting of 2 loops of Ø32 mm PE-Xa pipes was installed unto 45 meters depth and the bore hole was filled with sand (1.0 – 1,5 mm grains) and bentonite pellets (Mikolit B) in clay layers and near ground level in order to prevent seepages of rain etc. The sand was weathered with water after/during installation.

The samples were brought to VIA University College in Horsens, where the samples have been geological described and the natural moisture content was measured. For selected samples the gravity weight are measured, too.

The boring profile with all observations and measurements are shown in enclosure 2.10. Legends and abbreviations are shown in the enclosed GEO-Standard.

On five samples the grain size distribution have been analysed by sieving in GEOs laboratorium. The results are shown in enclosure 2.11.

2.3 Thermal response test

Two weeks after completion of boring 4 a thermal response test are performed by H.S.W. GmbH., Rostock.

The test report is enclosed in appendix A, "Bericht zum Geothermal Response Test".

2.4 Thermal laboratory tests

On selected samples from boring 4 VIA University College has performed measurements of the thermal conductivity and the heat capacity.

The tests of thermal conductivity have been performed in a Ø7 cm steel cylinder, in which the soil has been compressed. A protection pipe is inserted in the soil for placement of a 15 cm needle for measurements. Some friction heat may develop in the soil during this test procedure, which may require a rest period before measuring, but the procedure is considered to be appropriate for this project.

VIA has not yet prepared a report for the thermal tests. The results are listed in section 3.4.

In addition VIA University College is to perform tests of different grouting materials, which are considered to be used in the pilot thermal storage.

3 Results

3.1 Terrain

The terrain in the considered area is undulated. At the CPTs/borings the ground level are measured in level +115.7 to +119.8 (DVR90).

3.2 Soil strata

Below a thin layer of topsoil (mull) the soil mainly consists of glacial deposits with embedded layers of presumable interglacial strata (might be relocated during glacial periods).

Down to approx. 2 - 3 meters depth a soft (→ very soft) strata of clay till and silt are encountered.

Below this a firm to stiff (→ very stiff) strata of clay till is encountered unto 8 – 10 meters depth, covering melt water deposits of very dense sand (or gravel), in which most of the CPTs are stopped at maximum thrust. In 19 – 20 meters depth a layer of clay till is encountered unto 23.5 – 28 meters depth.

Underneath these layers melt water deposits of fine sand and/or sandy silt is encountered with embedded layers of clay till and sand till.

From 41 to 50 meters depth layers of sand/silt are presumably interglacial fresh water deposits, but they might be relocated during a glacial period.

CPT 6 differs slightly from the others, as the relatively soft/loose strata is encountered unto 5,7 meters depth and the underlying strata are dominated by sand with and embedded layer of clay till from 15.4 to 20.6 meters depth.

For a more precise description we are referring to the CPT and boring profiles in enclosure 2.1 – 2.10.

3.3 Groundwater

During drilling seepage of ground water were registered in the upper clay till, but the standpipes were dry at later soundings of groundwater tables. The borings were made in the late winter and early spring, whereas water from e.g. melting snow presumably has weathered the upper soil (seasonal secondary groundwater).

Below this the different soils were dry down to nearly 50 meters depth. During drilling groundwater was encountered in 49.3 meters depth. At a later sounding in the deep standpipe no groundwater table was recognized. Therefore, the groundwater table in the primary reservoir may be deeper than 51 meters (level +69). A study of other borings in

the neighbourhood (www.geus.dk) indicates a groundwater table in approx. level +65 in the primary groundwater reservoir.

These observations are confirmed by the measured natural water content, which generally is very low ($w = 2 - 8 \%$) in the sand deposits.

3.4 Thermal measurements

The thermal response test has shown a ground temperature of approx. $8 \text{ }^\circ\text{C}$. Thus, according to seasonal influence higher and lower temperatures have been measured in the upper approx. 8 meters, see figure 2.1. The response test is performed after a relatively cold winter and in the beginning of spring, which has caused respectively a colder zone in 2 to 8 meters depth and a warmer zone down to approx. 2 meters depth. During the introduction of the thermal test an average temperature of $8.18 \text{ }^\circ\text{C}$ is measured.

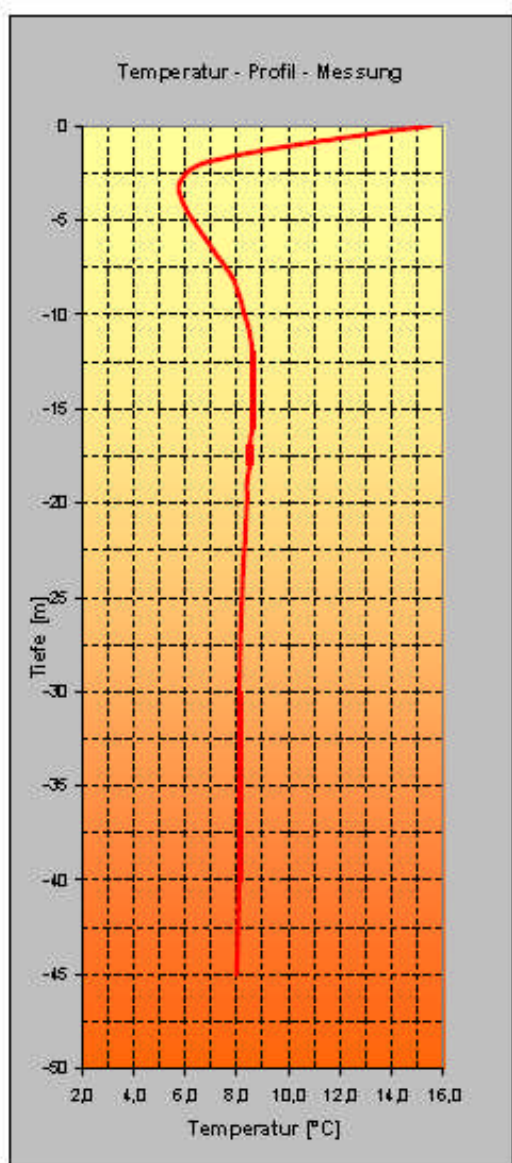

Figure 2.1: Temperature in borehole before thermal test

The thermal response test shows an overall thermal conductivity of the soil $\lambda = 1.42$ W/(m·K) and a thermal resistance for the actual borehole of $R_b = 0.172$ W/(K/m), referring to the formula given in the test report, appendix A, page 8.

VIA's test of thermal conductivity is shown in the following table 2.1:

Table 2.1: Thermal conductivities

Sample depth (m)	Main lithology	Thermal conductivity (W/(m·K))	Standard deviation (W/(m·K))
3-4	Silt and clay till	2.12*	0.11
3-4	Silt and clay till	2.88	2.21
7-8	Clay till	3.60	0.25
18-19	Sand, medium-coarse	0.22	0.00
26-27	Sand, fine	1.69*	0.01
37-38	Silt and sand	1.02	0.03
48-49	Sand and silt	0.55	0.02
49-50	Sand and silt	1.71*	0.02

*) The soil in these samples is manual compressed, the others are pressured by hydraulic.

These values are generally comparable with the result of the thermal response test, which represent an average value for the soil to 45 meters depth.

Danish soils consist mainly of quartz and feldspar, and the heat capacity c can be calculated using the formula:

$$c = \frac{1}{\gamma} \left[\left(c_f \gamma_f \frac{V_f}{V} \right) + \left(c_q \gamma_q \frac{V_q}{V} \right) + \left(c_w \gamma_w \frac{V_w}{V} \right) + \left(c_a \gamma_a \frac{V_a}{V} \right) \right]$$

where	$c_f = 0.803$ kJ/kg·K	Heat capacity of feldspar
	$c_q = 0.699$ kJ/kg·K	Heat capacity of quartz
	$c_w = 4.160$ kJ/kg·K	Heat capacity of water
	$c_a = 1.010$ kJ/kg·K	Heat capacity of air
	γ	Unit weight of soil
	$\gamma_f \approx 2670$ kg/m ³	Unit weight of feldspar grains
	$\gamma_q \approx 2650$ kg/m ³	Unit weight of quartz grains
	$\gamma_w \approx 1000$ kg/m ³	Unit weight of water
	$\gamma_a \approx 12$ kg/m ³	Unit weight of air
	$V_f V_q V_w V_a$	Volume of resp. feldspar, quartz, water and air
	V	Volume total

The distribution of feldspar and quartz in the soil, the unit weight of the soil etc. can be evaluated on basis of the measurements and our general experience with the encountered soils as listed in table 2.2. The values are given for soils above groundwater level.

Table 2.2: Estimation of heat capacities (above groundwater).

Soil	Unit weight (kg/m ³)	Natural water content (%)	Estimated distribution of minerals (%)		Estimated distribution of volume (%)				Heat capacity (kJ/(kg·K))	Volumetric heat capacity (MJ/(m ³ K))
			Feldspar	Quartz	Feldspar	Quartz	Water	Air		
Sand, sorted	1800	5	5	95	3	65	5	27	0.82	1.5
Silt/sand, unsorted	2000	7	10	90	8	67	7	18	0.86	1.7
Clay till	2200	13	20	80	17	66	13	4	0.97	2.1

VIA has performed one test of the heat capacity on a partial sample from 10-11 meters depth in boring 4. The results of the test are listed in table 2.2.

Table 2.3: Measured heat capacity

Sample depth (m)	Main lithology	Heat capacity c (KJ/kg K)	Unit weight γ (kg/m ³)	Volumetric heat capacity C (MJ/m ³ K)
10-11	Sand, unsorted	0.99	1934	1.91

The measured heat capacity seems to be slightly higher than expected from the calculated values, but within a general uncertainty of approx. 10 %.

4 Evaluation

4.1 Generally suitability

The performed site investigation has shown that the area is suitable for a borehole energy storage, primarily caused by the fact that no horizontal groundwater flow may be expected down to (at least) 50 meters depth.

The soil consists of clay till, which is a relatively well suited for energy storage. The encountered layers of dry sand are though less suited.

The upper 2 - 3 meters of soil are relatively soft, but the layers below are generally stiff/dense and very stiff/very dense. These conditions shall be taken into account in the planning of drilling method and choice of equipment for the energy boreholes.

4.2 Thermal properties

On the basis of the performed site investigation we recommend to use the following average values in the design of a pilot energy storage with borings to 45 meters depth.

Thermal conductivity: $c = 1.42 \text{ W}/(\text{m}\cdot\text{K})$

Heat capacity: $c = 0.9 - 1.0 \text{ kJ}/(\text{kg}\cdot\text{K})$

Volumetric heat capacity: $C \approx 1.8 - 2.0 \text{ MJ}/(\text{m}^3\text{K})$

The thermal conductivity is relatively low, primarily caused by dry sands.

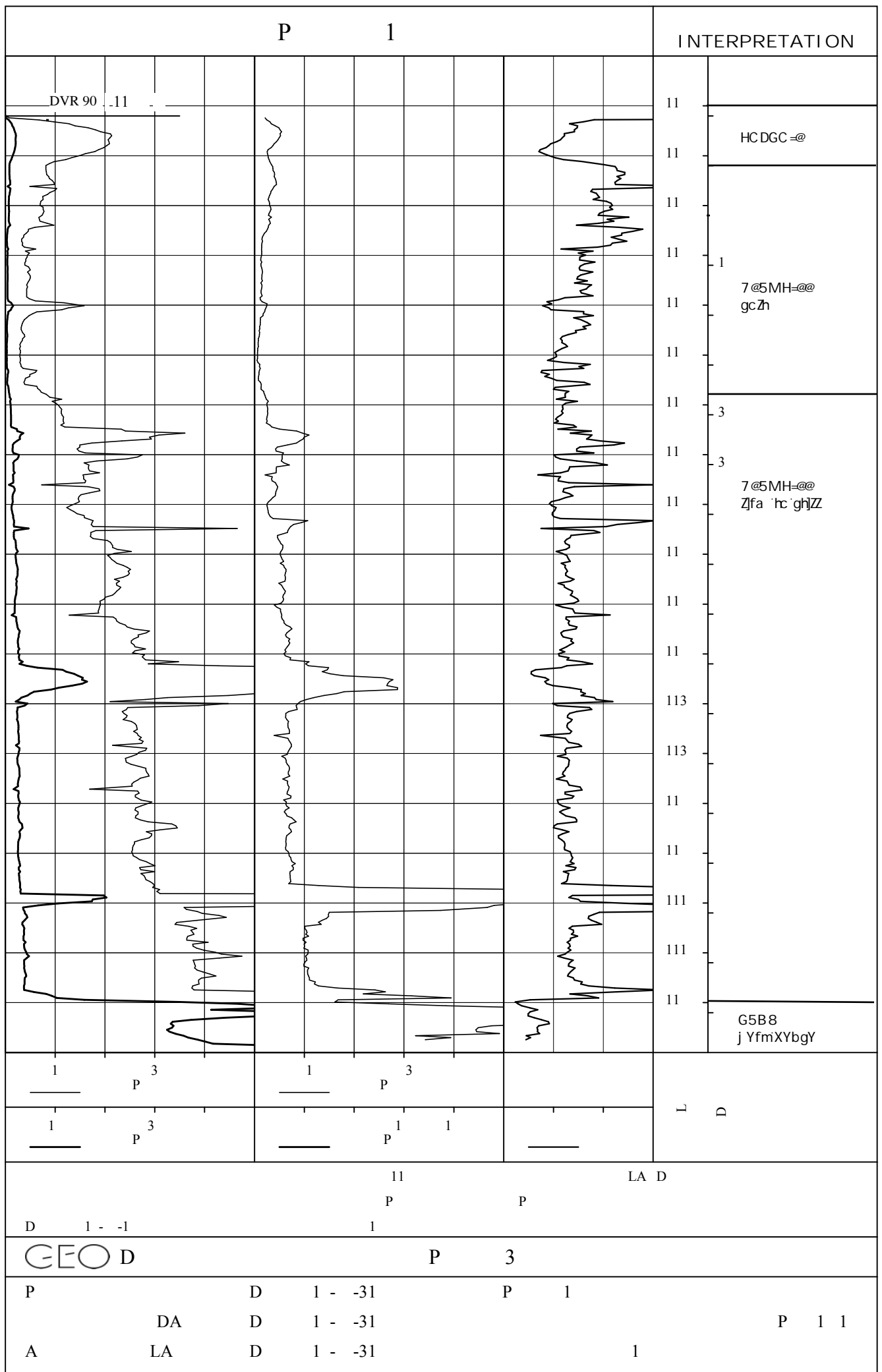

P						INTERPRETATION	
8JF- \$ 11						11	
						11	HCDGC=@
						11	
						11	1 7@5MH=@@ gcZh
						11	
						11	3 7@5MH=@@ Zjfa 'hc'ghjZ
						11	3
						11	
						11	
						113	
						113	
						11	
						11	
						111	
						111	
						11	
						L	D
						11 LA D	
						P	P
D 1 - -1						1	1
GEO D						P	3
P		D	1 - -31		P		
	DA	D	1 - -31			P	1
A	LA	D	1 - -31				

P										INTERPRETATION			
										1	1	G5B8 j YfmXYbgY	
										1	1		
										1	1		
										1	11		
										1	11		
										1	1		
										1	1		
										1	13		
										1	13		
										1	1		
										1	1		
										1	1		
										1	1		
										1	1		
										1 3	1		
										1 3	1		
										1	1		
										1	1		
										1 1	1		
										1 1	1		
										1	1		
1 P 3													
1 P 3										1 D			
1 P 1 1													
11 LA D													
P P													
D 1 - -1 1 1													
EEO D P 3													
P D 1 - -31 P													
DA D 1 - -31 P													
A LA D 1 - -31													

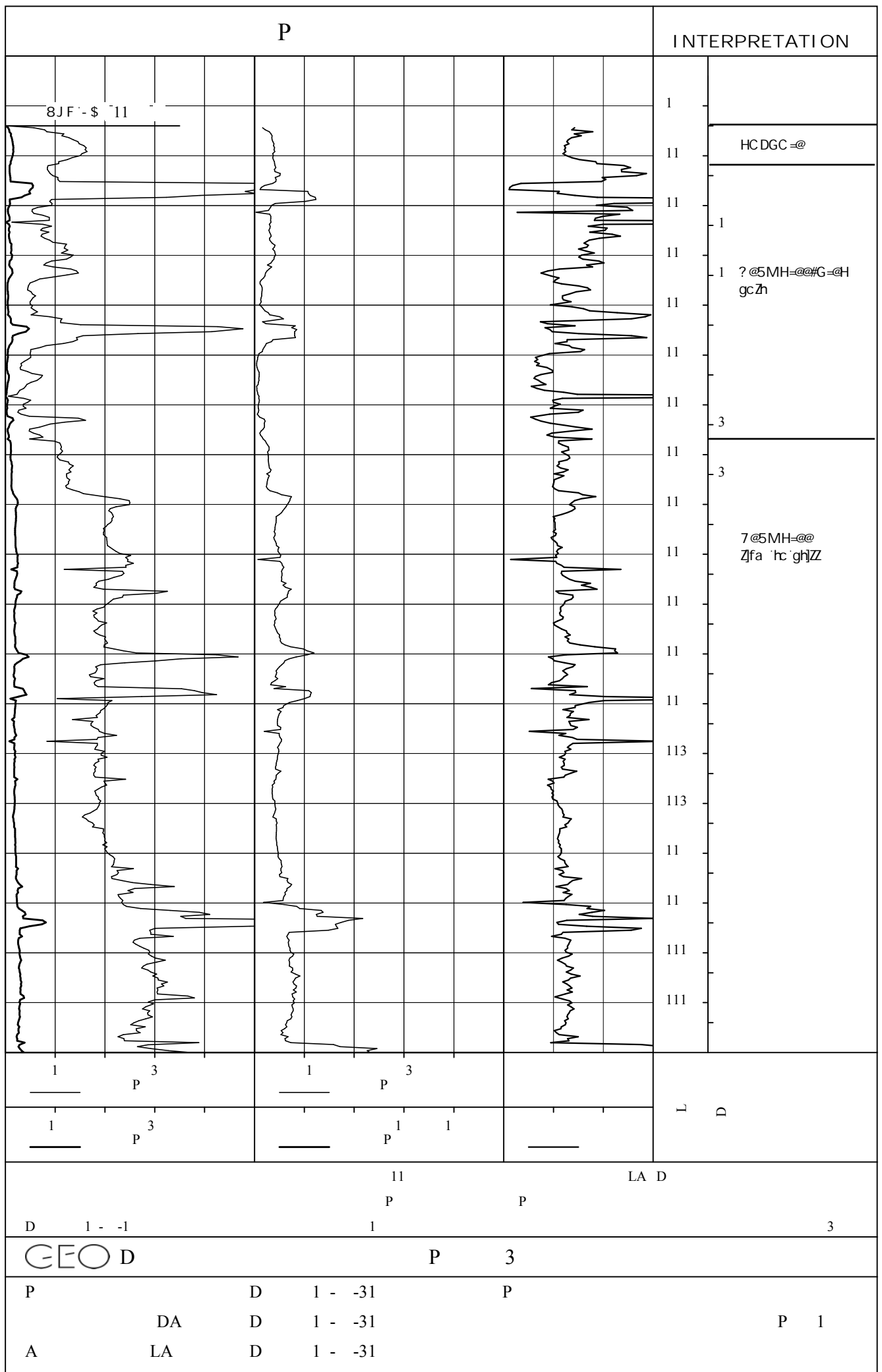

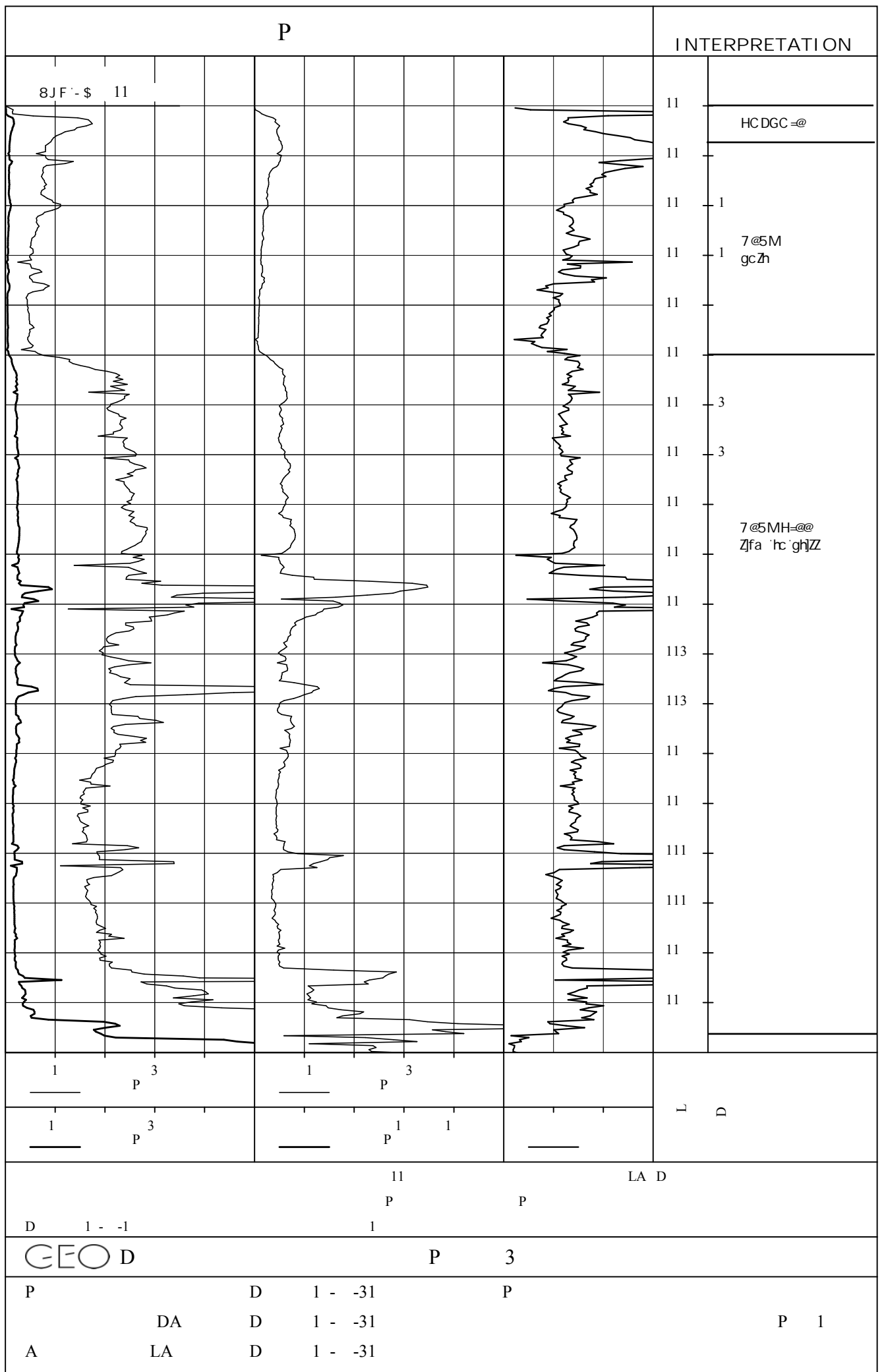

P			INTERPRETATION
8JF-\$ 11			11
			11 HCDGC=@
			11 7@5MH=@@ gcZh k]h`gUbX`UmYfg
			113
			113
			3
			11
			3
			111
			111 G=@H j YfmgcZh k]h`WUm`UmYfg
			11
			1 G=@H Z]fa`hc`gh]Z [fUj Y`mB
			1
			1
			1 G5B8 `ccgY`hc XYbgY
			1
1	3		L D
1	3		
1	3	1 1	
11			LA D
P			P
D	1 - -1	1	3
GEO D			P 3
P		D	1 - -31 P
	DA	D	1 - -31 P 1 3
A	LA	D	1 - -31

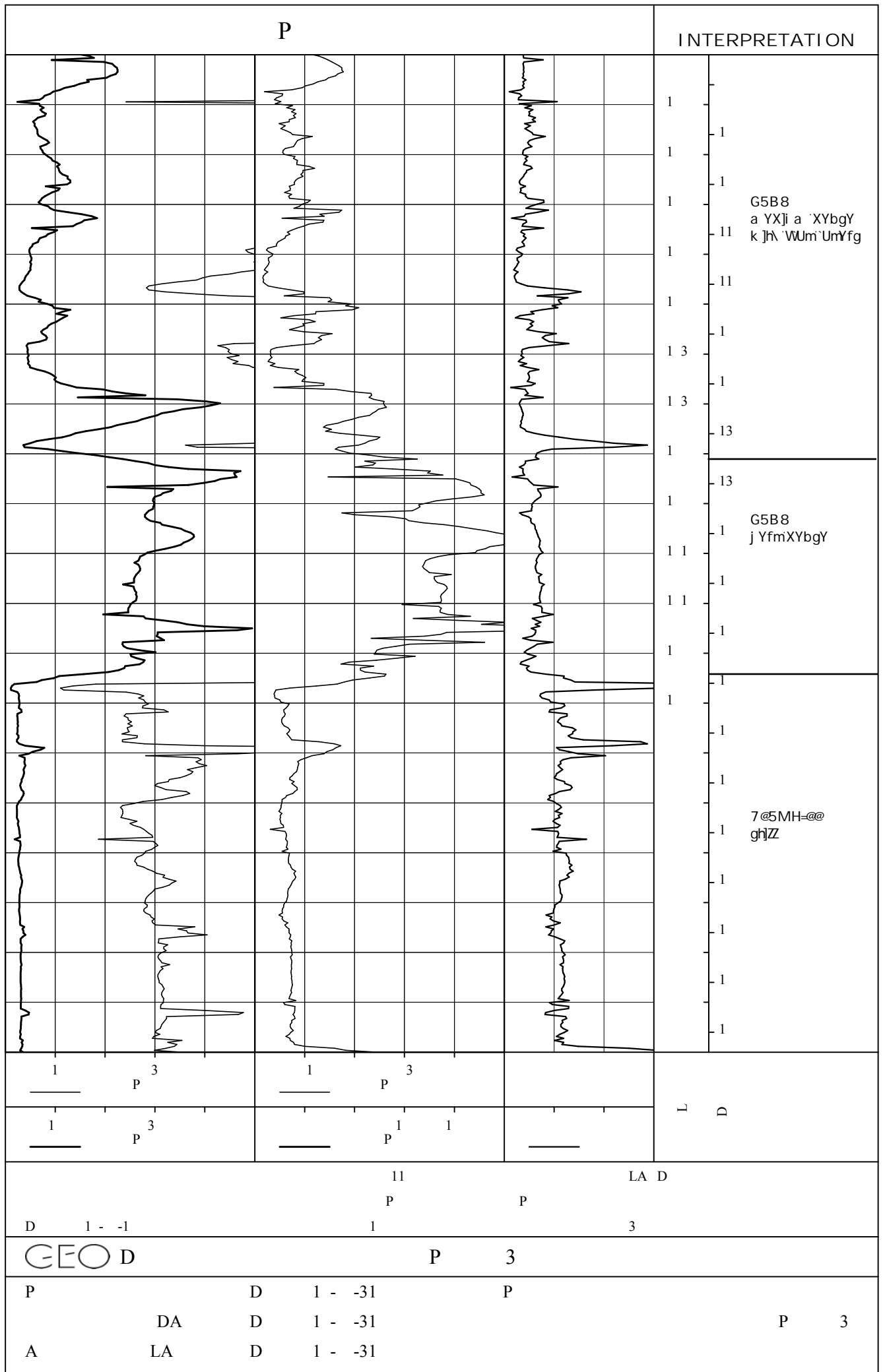

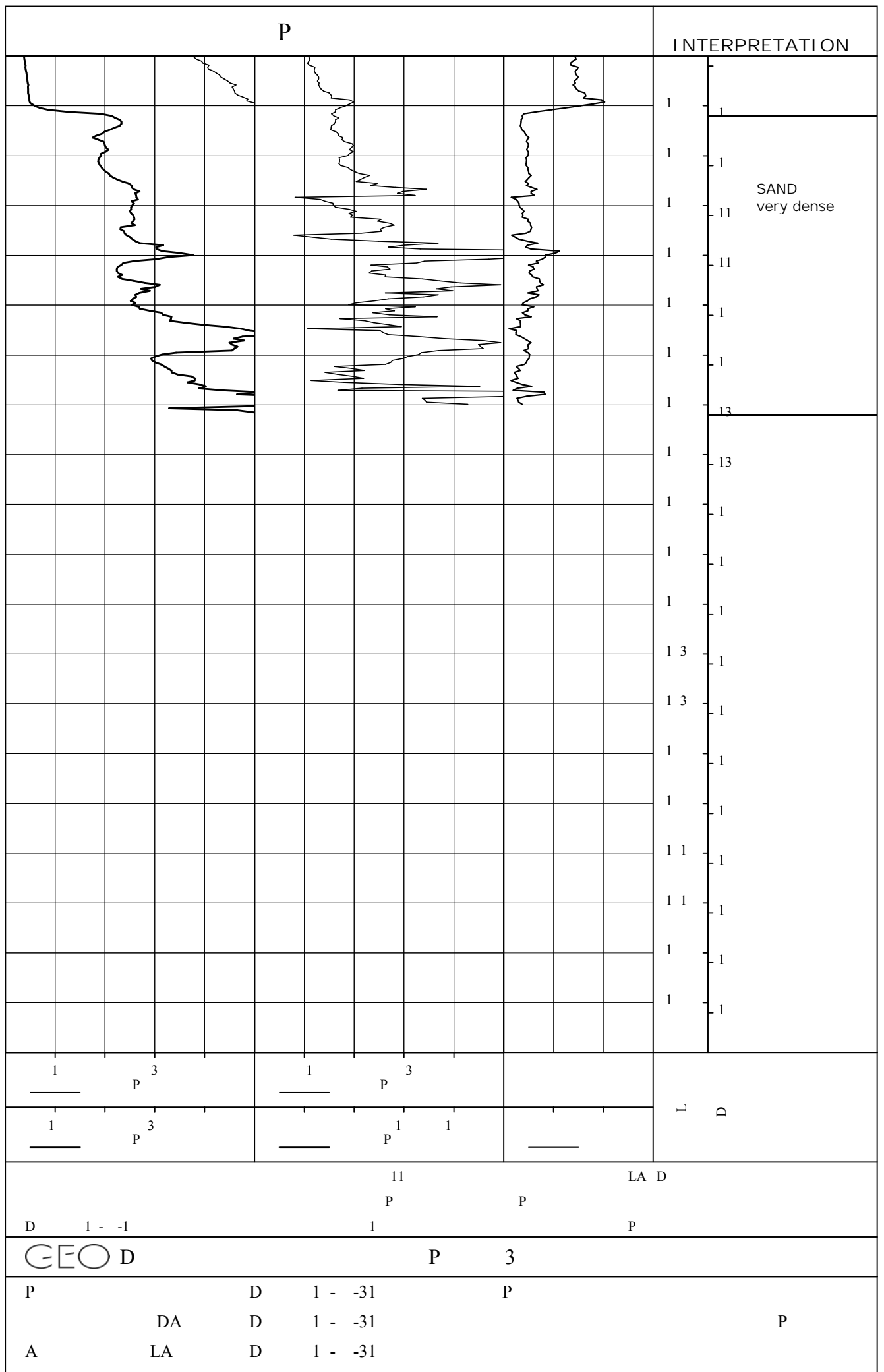

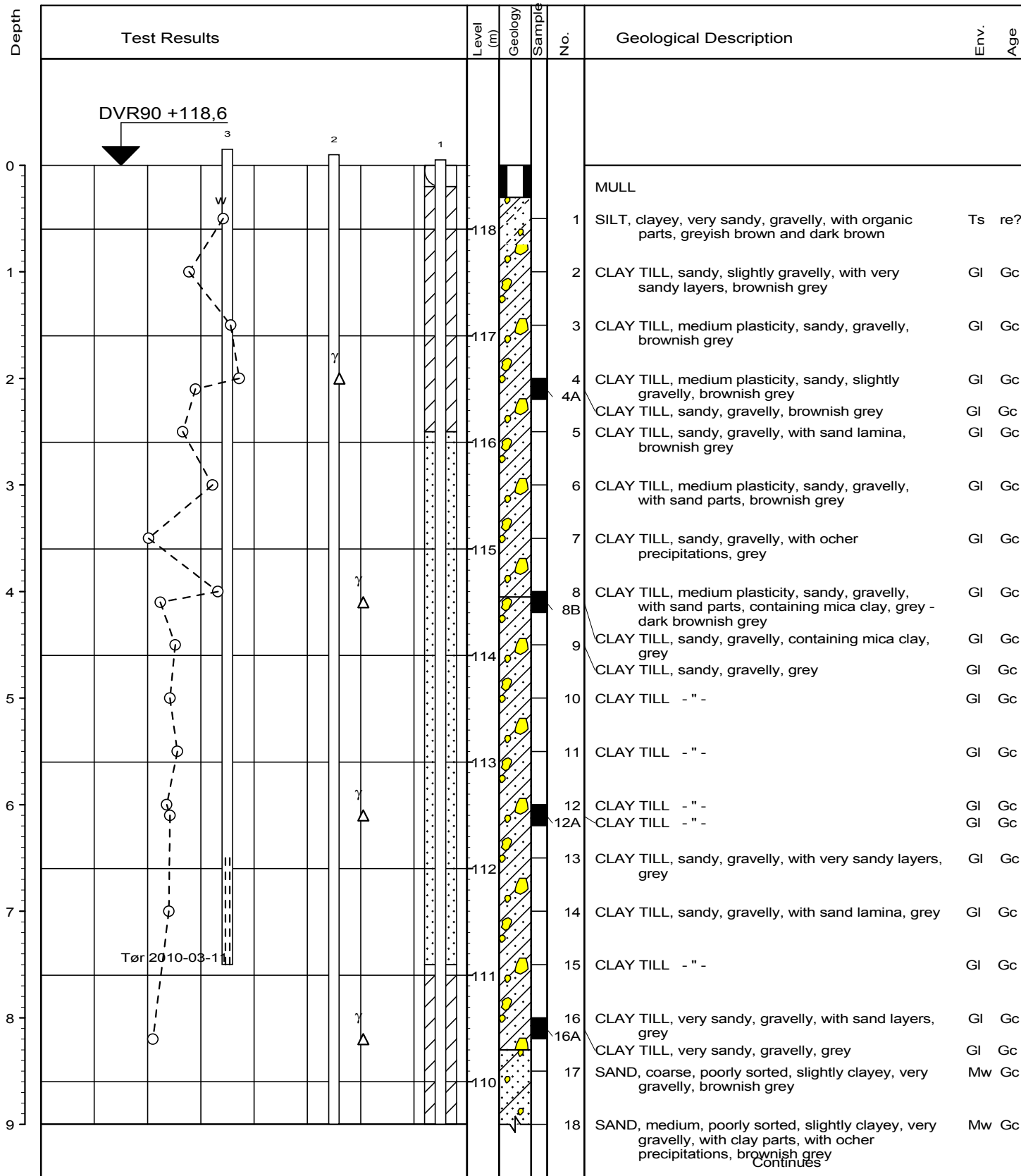

Method : Tørboring 6"

Location plan :

Job : 32926

Brædstrup

Ing. geologSFJ

Drilled by : GEO BAO

Date : 2010-02-23

Synonym :

Boring : 3

Executed by : GSJ

Checked by : JDA

Approved by : PBF

Date :

Encl. No.: 2.9

P. 1 / 3



Sødalsparken 12, 8220 Brabrand
tlf 8627 3111 , www.geo.dk

Profile

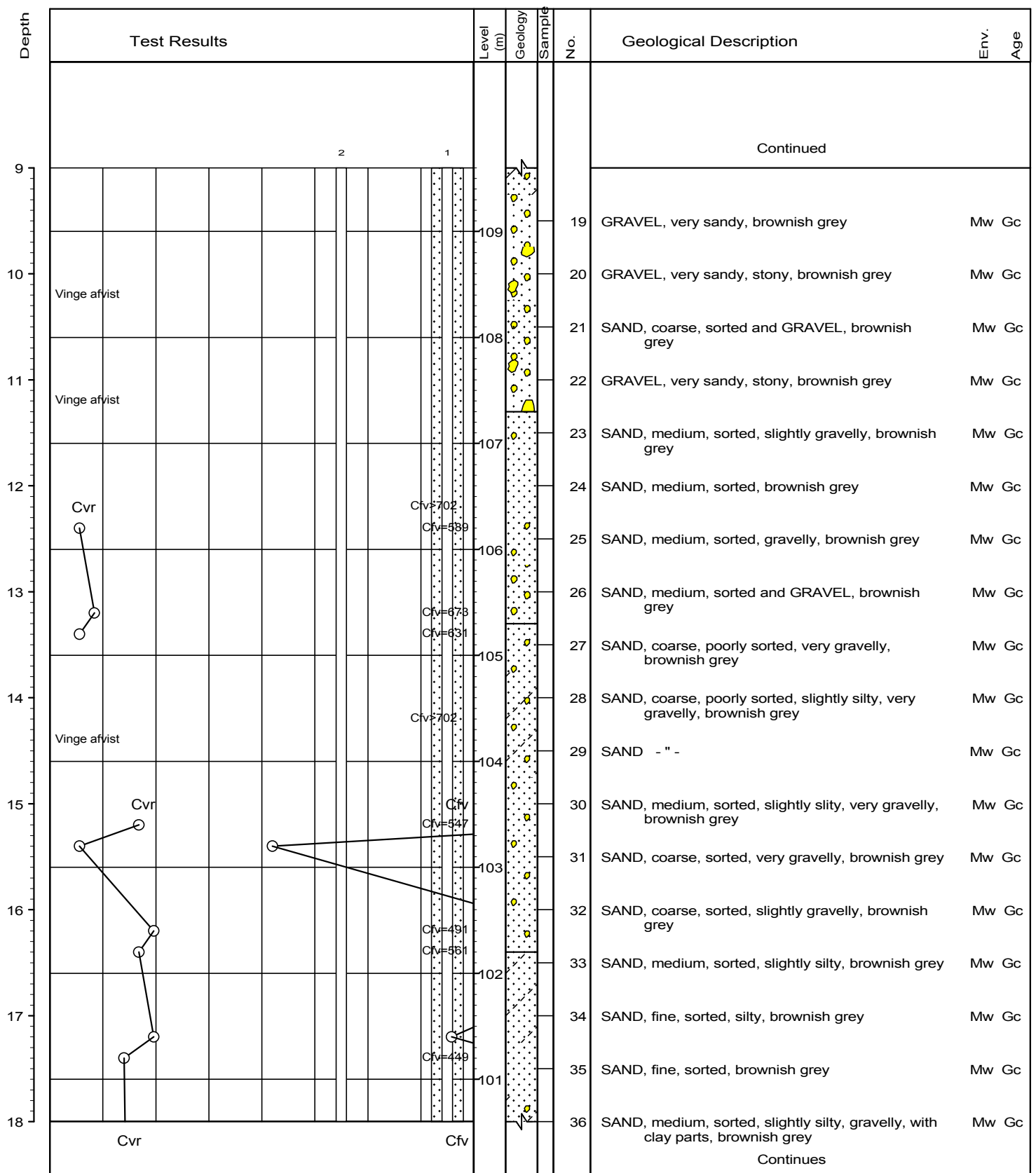

○	10	20	30	W (%)
△	14	18	22	γ (kN/m³)
○	100	200	300	Cfv, Cvr (kN/m²)

Method : Tørboring 6"

Location plan :

Job : 32926 Brædstrup
 Ing. geologSFJ Drilled by : GEO BAO Date : 2010-02-23 Synonym : Boring : 3
 Executed by : GSJ Checked by : JDA Approved by : PBF Date : Encl. No.: 2.9 P. 2 / 3



Sødalsparken 12, 8220 Brabrand
 tlf 8627 3111 , www.geo.dk

Profile

BRegister - PSTGUK 2.0 - 24/06/2010 09:07:11

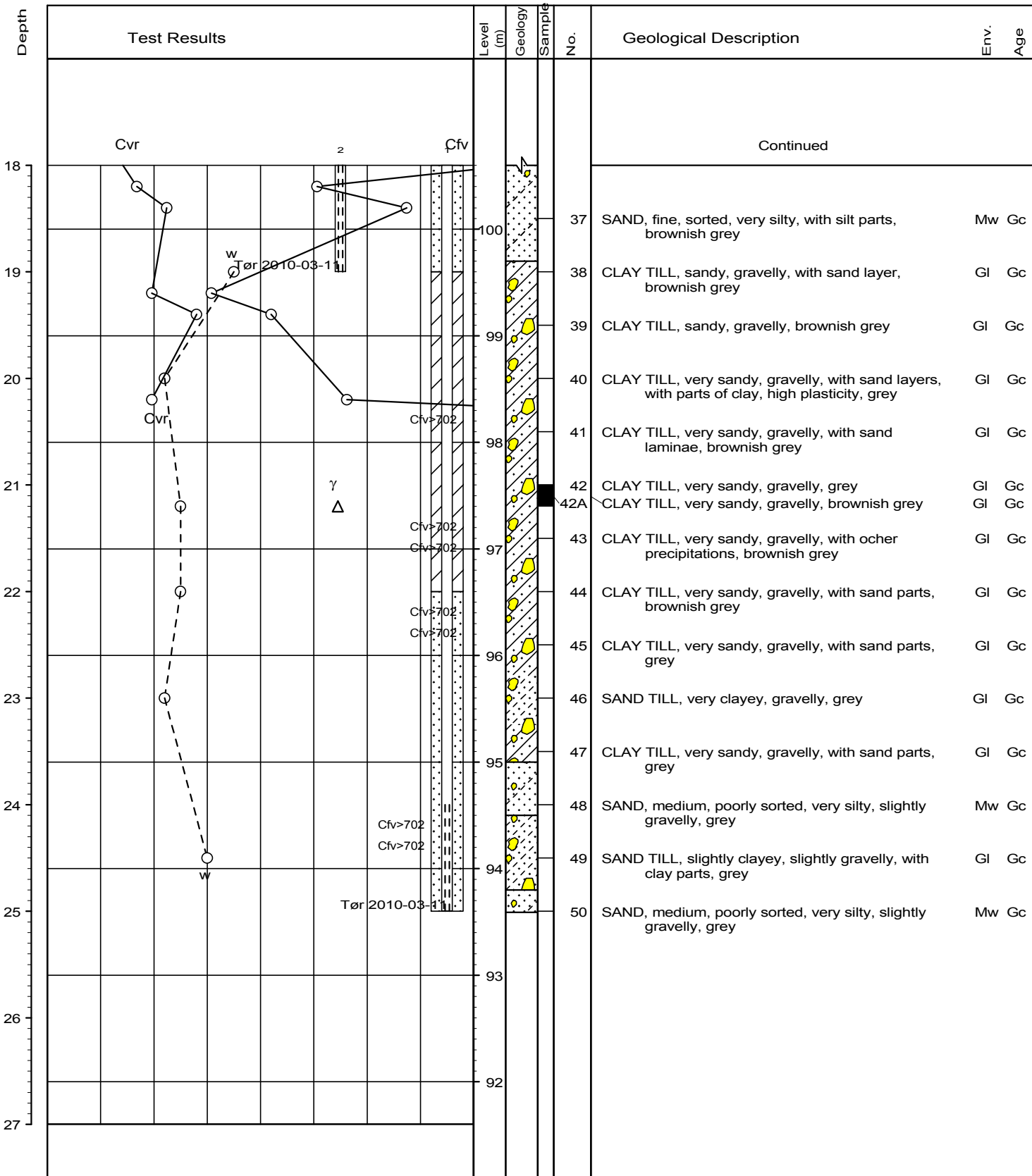

○	10	20	30	W (%)
△	14	18	22	γ (kN/m ³)
○	100	200	300	Cfv, Cvr (kN/m ²)

Method : Tørboring 6"

Location plan :

Job : 32926

Brædstrup

Ing. geologSFJ

Drilled by : GEO BAO

Date : 2010-02-23

Synonym :

Boring : 3

Executed by : GSJ

Checked by : JDA

Approved by : PBF

Date :

Encl. No.: 2.9

P. 3 / 3



Sødalsparken 12, 8220 Brabrand
tlf 8627 3111 , www.geo.dk

Profile

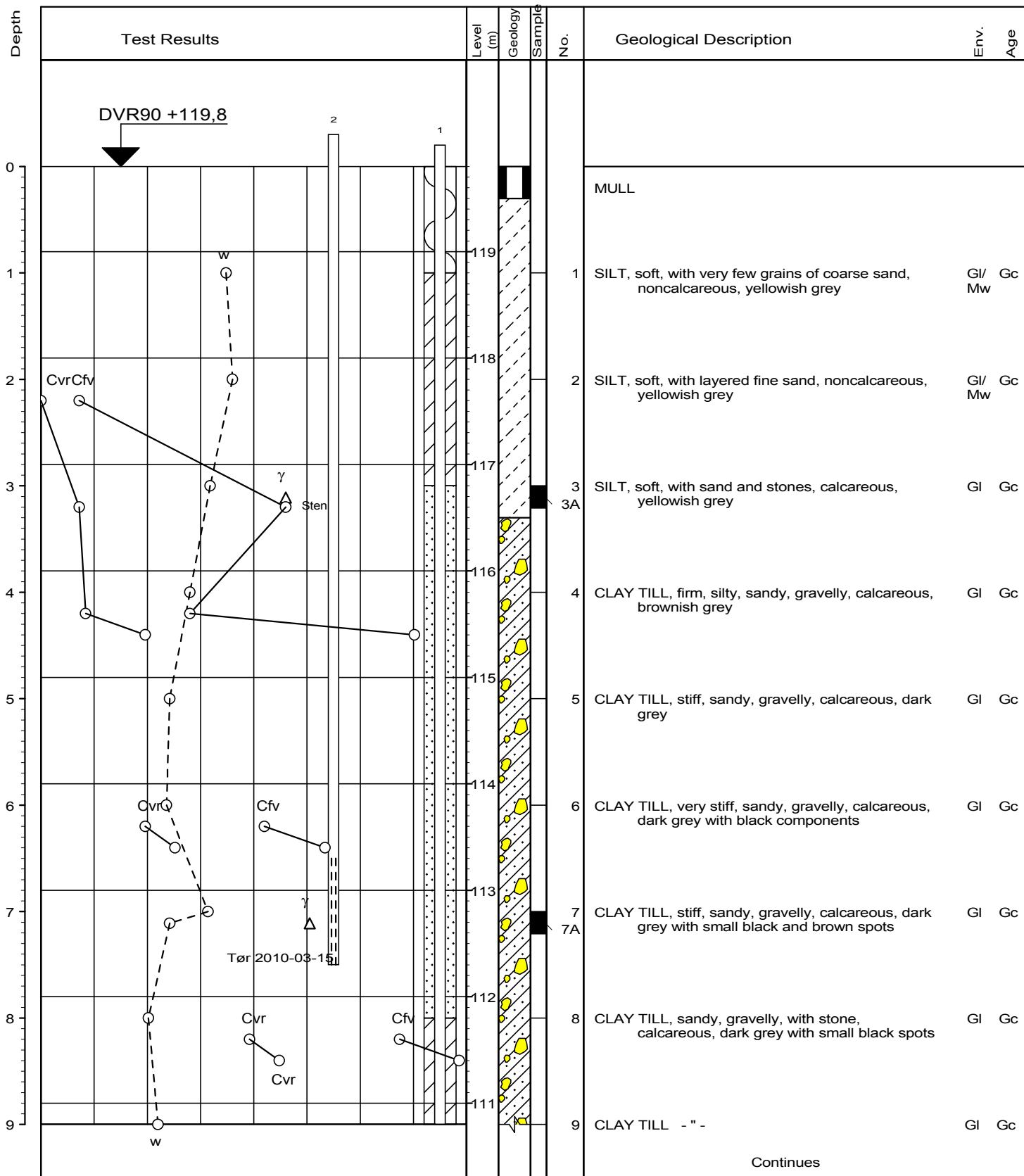

○	10	20	30	W (%)
△	14	18	22	γ (kN/m ³)
○	100	200	300	Cfv, Crv (kN/m ²)
▼	10	20	30	N (Blows/30 cm)

Method : Foret rotationsboring 10"

Location plan :

Job : 32926

Brødstrup

Ing. geolog :

Drilled by : GEO KHH/WIH Date : 2010-03-09

Boring : 4

Executed by : BEB

Checked by : JDA

Approved by :

Date :

Encl. No.: 2.10

P. 1 / 6



Sødalsparken 12, 8220 Brabrand
tlf 8627 3111 , www.geo.dk

Profile

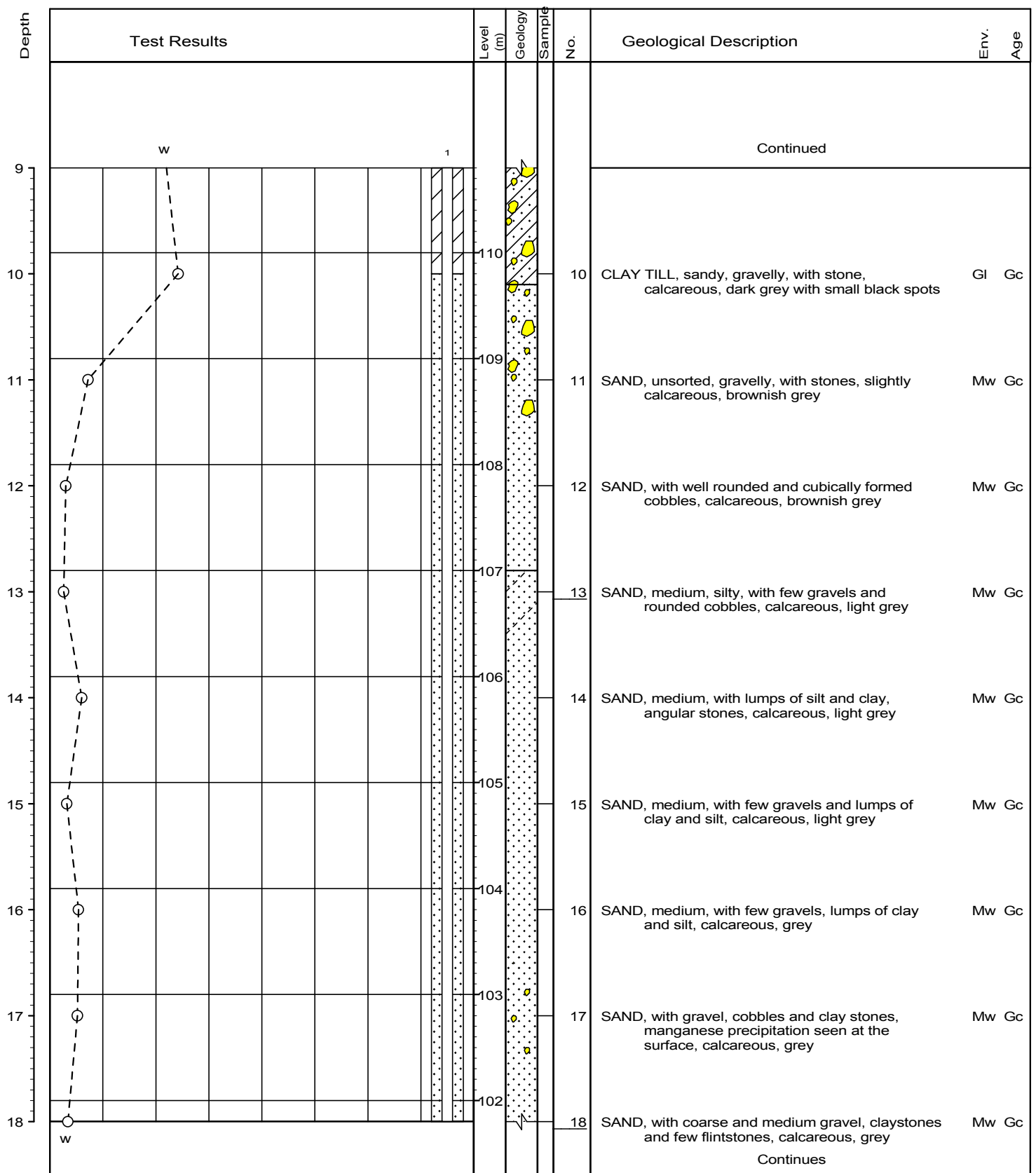

○	10	20	30	W (%)
△	14	18	22	γ (kN/m ³)
○	100	200	300	C _f , C _{rv} (kN/m ²)
▼	10	20	30	N (Blows/30 cm)

Method : Foret rotationsboring 10"

Location plan :

Job : 32926 Brædstrup
 Ing. geolog : Drilled by : GEO KHH/WIH Date : 2010-03-09 Synonym : Boring : 4
 Executed by : BEB Checked by : JDA Approved by : Date : Encl. No.: 2.10 P. 2 / 6



Sødalsparken 12, 8220 Brabrand
 tlf 8627 3111 , www.geo.dk

Profile

BRegister - PSTGUK 2.0 - 24/06/2010 09:08:42

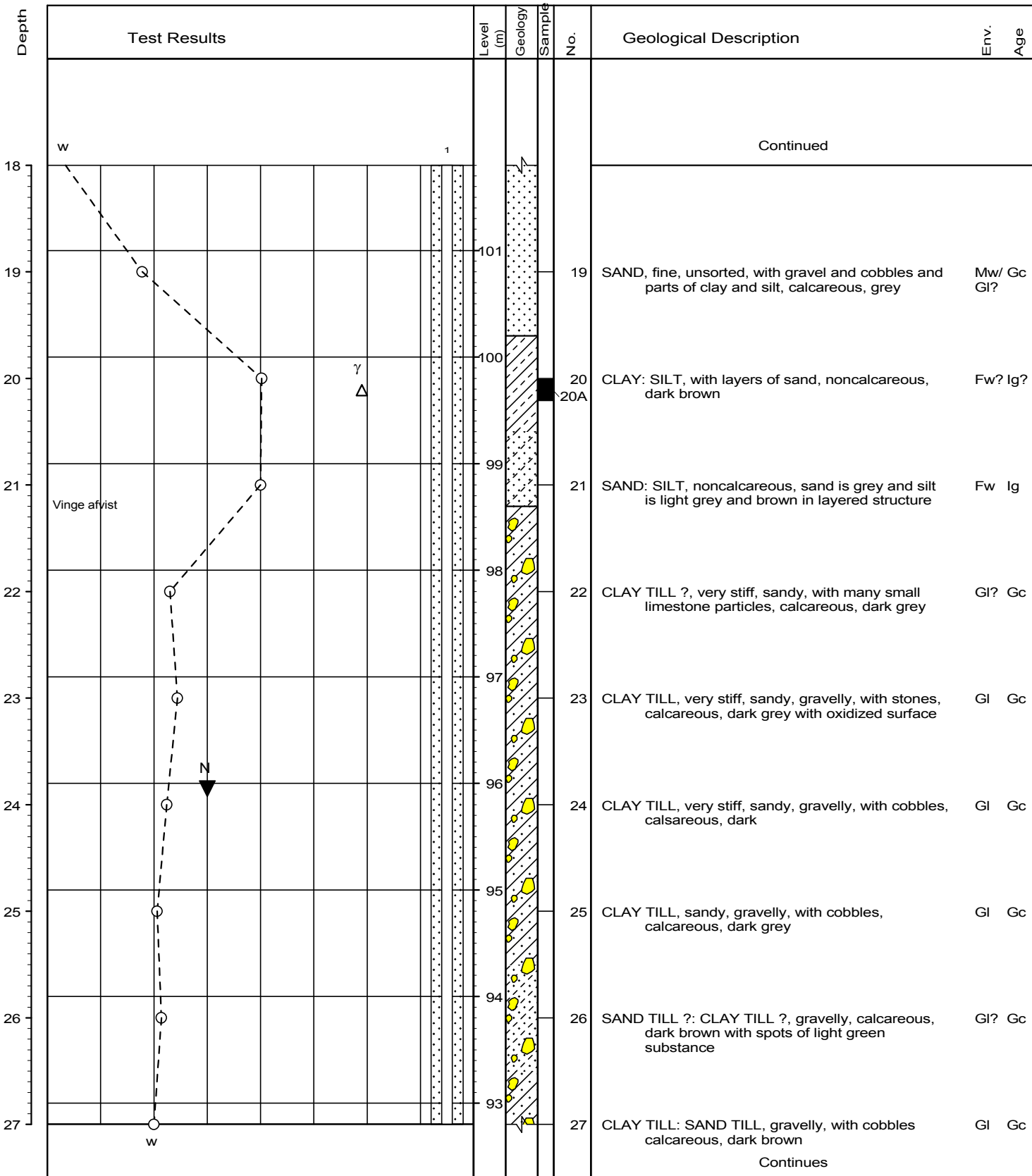

○	10	20	30	W (%)
△	14	18	22	γ (kN/m ³)
○	100	200	300	Cfv, Crv (kN/m ²)
▼	10	20	30	N (Blows/30 cm)

Method : Foret rotationsboring 10"

Location plan :

Job : 32926 Brødstrup
 Ing. geolog : Drilled by : GEO KHH/WIH Date : 2010-03-09 Synonym : Boring : 4
 Executed by : BEB Checked by : JDA Approved by : Date : Encl. No.: 2.10 P. 3 / 6



Sødalsparken 12, 8220 Brabrand
 tlf 8627 3111 , www.geo.dk

Profile

BRegister - PSTGUK 2.0 - 24/06/2010 09:08:42

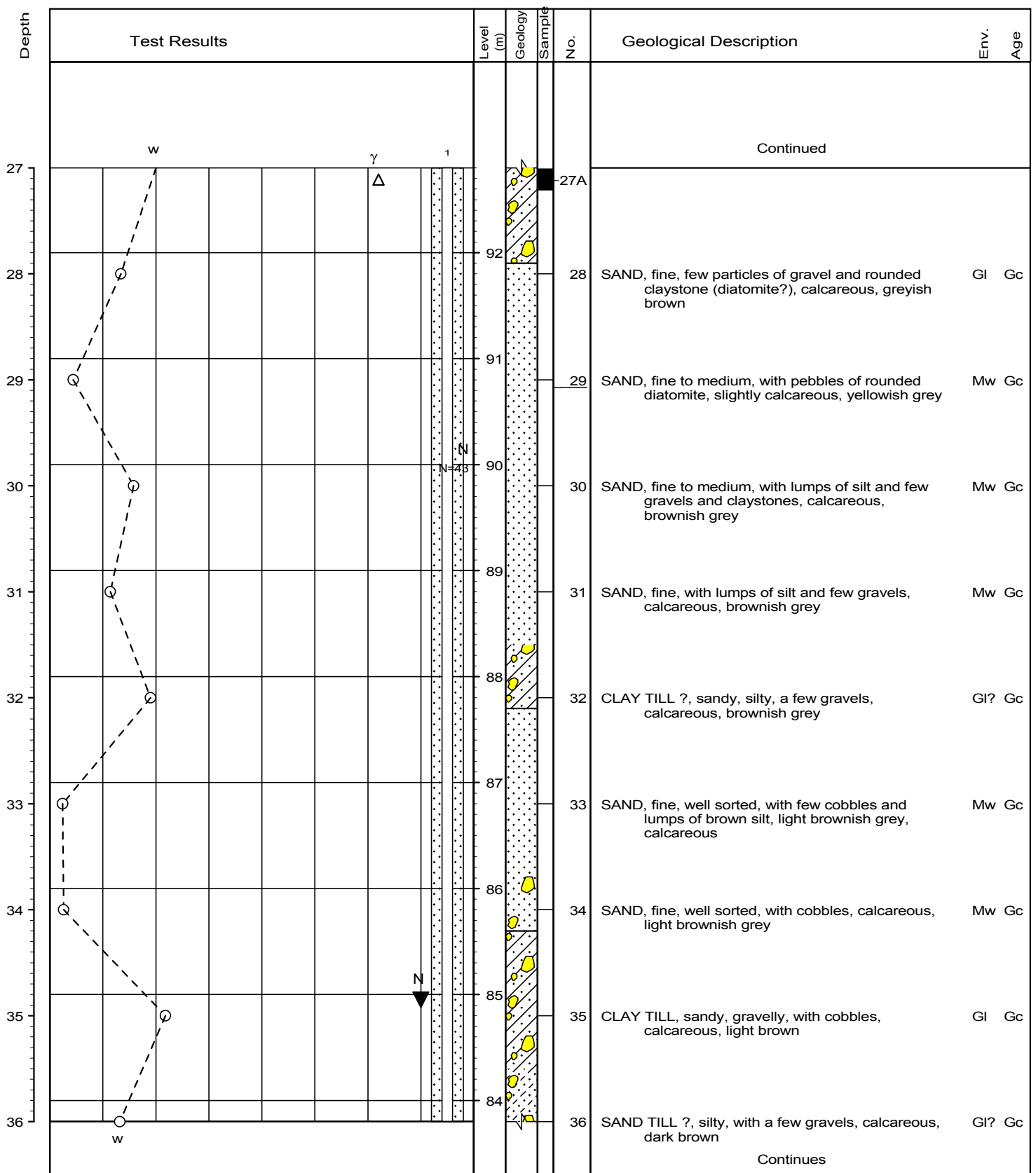

○	10	20	30	W (%)
△	14	18	22	γ (kN/m³)
○	100	200	300	Cfv, Crv (kN/m²)
▼	10	20	30	N (Blows/30 cm)

Method : Foret rotationsboring 10"

Location plan :

BRegister - PSTGUK 2.0 - 24/06/2010 09:08:42

Job : 32926 Brædstrup
 Ing. geolog : Drilled by : GEO KHH/WIH Date : 2010-03-09 Synonym : Boring : 4
 Executed by : BEB Checked by : JDA Approved by : Date : Encl. No.: 2.10 P. 4 / 6



Sødalsparken 12, 8220 Brabrand
 tlf 8627 3111 , www.geo.dk

Profile

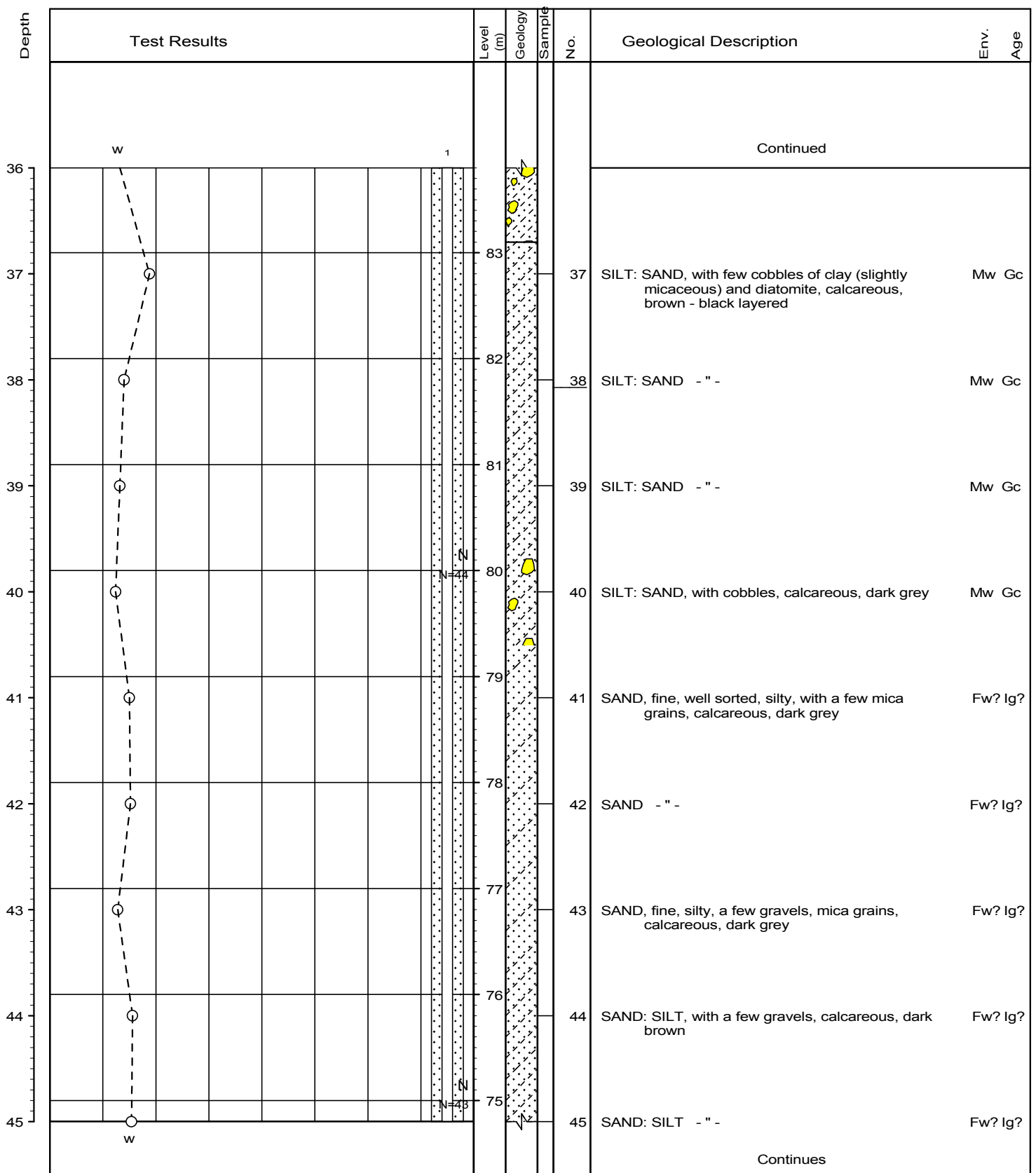

○	10	20	30	W (%)
△	14	18	22	γ (kN/m³)
○	100	200	300	C _{fv} , C _{rv} (kN/m²)
▼	10	20	30	N (Blows/30 cm)

Method : Foret rotationsboring 10"

Location plan :

Job : 32926 Brædstrup
 Ing. geolog : Drilled by : GEO KHH/WIH Date : 2010-03-09 Synonym : Boring : 4
 Executed by : BEB Checked by : JDA Approved by : Date : Encl. No.: 2.10 P. 5 / 6



Sødalsparken 12, 8220 Brabrand
 tlf 8627 3111 , www.geo.dk

Profile

BRegister - PST/GUK 2.0 - 24/06/2010 09:08:42

Depth	Test Results					Level (m)	Geology	Sample No.	Geological Description	Env.	Age
45									Continued		
46						74		46	SAND: SILT, with a few gravels, calcareous, dark brown	Fw?	Ig?
47						73		47	SAND: SILT - " -		Fw? Ig?
48						72		48	SAND: SILT, with a little gravel, calcareous, dark brown	Fw?	Ig?
49						71		49	SAND: SILT - " -		Fw? Ig?
50						70		50	SAND: SILT, with a little gravel, calcareous, dark brown	Fw?	Ig?
51						69		51	CLAY TILL: SILT TILL, sandy, with a few gravels and claystone cobbles, calcareous, dark brown	Gl	Gc
52						68			note, the geological descriptions are performed by inga sørensen, via, and adjusted by geo		
53						67			note, the borehole is equipped with geothermal pipes to 45 meters depth (2 loops of ø32mm pexa)		
54						66					

2010-03-15

○	10	20	30	W (%)
△	14	18	22	γ (kN/m³)
○	100	200	300	Cfv, Crv (kN/m²)
▼	10	20	30	N (Blows/30 cm)

Method : Foret rotationsboring 10"

Location plan :

BRegister - PSTGJUK 2.0 - 24/06/2010 09:08:42

Job : 32926 Brædstrup
 Ing. geolog : Drilled by : GEO KHH/WIH Date : 2010-03-09 Synonym : Boring : 4
 Executed by : BEB Checked by : JDA Approved by : Date : Encl. No.: 2.10 P. 6 / 6



Sødalsparken 12, 8220 Brabrand
 tlf 8627 3111 , www.geo.dk

Profile

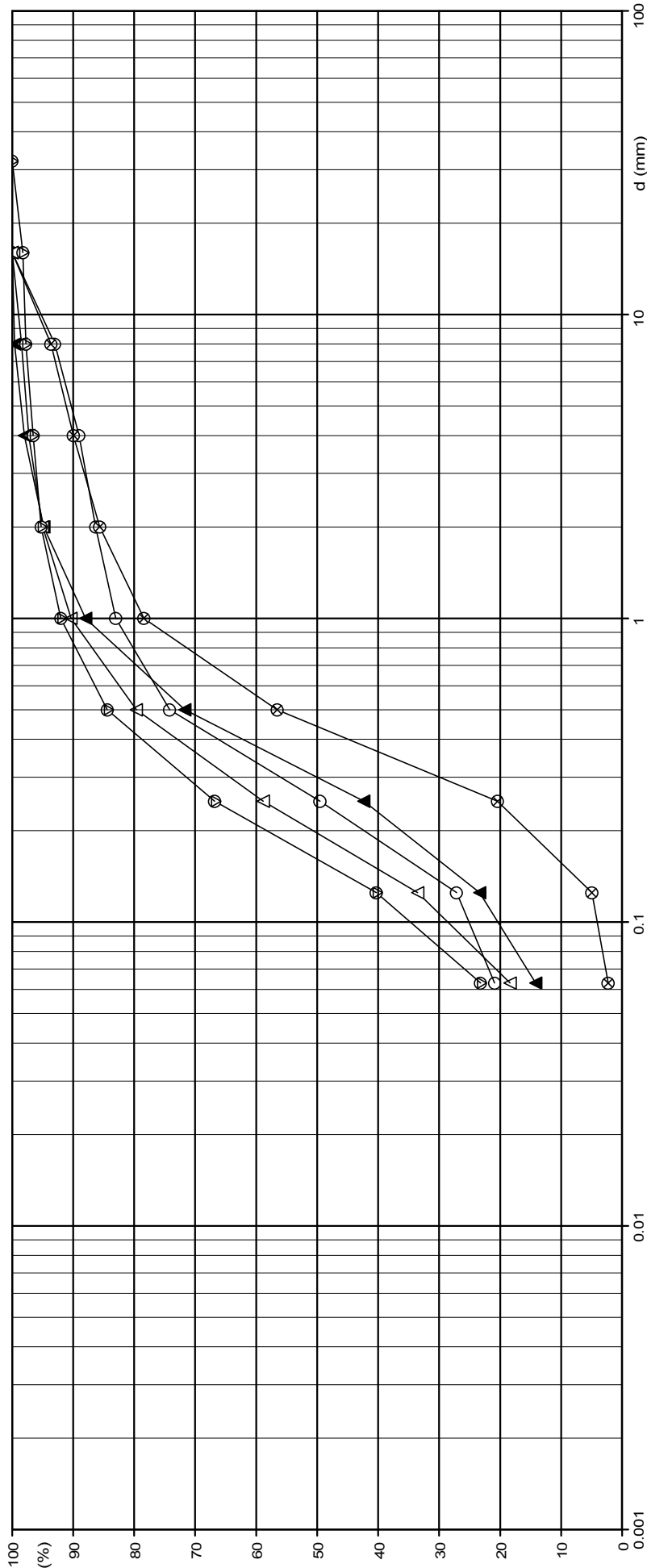

LER	SILT			SAND			GRUS			STEN					
	FIN	MELLEM	GROV	FIN	MELLEM	GROV	FIN	MELLEM	GROV						
Boring/Prøve Nr. :			4 / 13			4 / 18			4 / 29			4 / 38			4 / 46
Kurvesignatur			○			⊗			▲			△			⊙
Geologi			SAND			SAND			SAND			SILT: SAND			SAND: SILT
Middelkornstørrelse d_{50} (mm)			0,253			0,441			0,3			0,196			0,161
Uensformighedsindeks $d_{60}(mm) / d_{10}(mm)$			0,336 /			0,558 / 0,157 = 3,55			0,379 /			0,26 /			0,209 /
Plasticitetsindeks $W_L - W_P = I_P$ (%)			-			-			-			-			-
Aktivitet I_P (%) / ler (%) = I_A			/			/			/			/			/
CaCO ₃ (%)															
Kornrumvægt d_s															
Sandækvivalent SE															
Note															



Sødalsparken 12, 8220 Brabrand
tlf 8627 3111, www.geo.dk

KORNKURVE

Forsøg : GSJ Dato : 100526
Kontrol : GSJ Dato : 100526
Godkendt : JDA Dato : 100526

Sag : 32926 Brædstrup



Sødalsparken 12, 8220 Brabrand
Tlf.: +45 8627 3111, www.geo.dk

Project: 32926 Brædstrup

Prepared : MOK Dato: 2010-04-11

Subject: Fotos of installation of thermal pipe

Controlled : Dato:

Approved : JDA Dato: 2010-06-09

Report 2

Enclosure 2.12



Signatures :

CPT and boring



CPT



GEO 12 Sødalsparken, DK-8220 Brabrand
Phone: +45 8627 3111, www.geo.dk

JOB: 32926 Brødstrup

Prepared	: BEB	Date: 2010-06-01	Subject: Siteplan
Controlled	: JDA	Date: 2010-06-03	Scale ~1:2000
Approved	: MOK	Date: 2010-06-09	Report 2

Enclosure 2.13

Appendix 2.A

Bericht zum Geothermal Response Test



Sødalsparken 12, 8220 Brabrand
Tel: +45 8627 3111, www.geo.dk

Job: 32926 Brædstrup

Prepared : JDA Date: 2010-06-03 Subject: Geothermal Response Test

Controlled : Date:

Page 1 / 19

Approved : Date:

Report 2

Appendix 2.A

Bericht zum Geothermal Response Test

für die geplante Erdwärmenutzung am Standort
Fjernvarmvej 2
in 8740 Braedstrup (Königreich Dänemark)

Auftraggeber:

GEO (The Danish Geotechnical Institute)

Sodalsparken 12
8220 Brabrand

Auftragnehmer:

H.S.W. GmbH

Ingenieurbüro für Angewandte und Umweltgeologie

Gerhart-Hauptmann-Straße 19
18055 Rostock



DAP-PL-3135.00

DIN EN ISO/IEC 17025:2005
u.a. Probenahme von Wasser, Böden und Beprobung von Grundwasserleitern; Durchführung und Auswertung von Geothermal Response Tests

phone: 0049(0)381/37015

fax: 0049(0)381/31224

e-mail: hsw.ingbuero@t-online.de

Bearbeiter:

Dipl.-Ing. Thomas Hanschke

Dipl.-Ing. Jens-Uwe Kühl

erstellt: Rostock, am 11.05.2010

www.response-test.de



Inhalt	Seite
1. Anlass.....	1
2. Testdurchführung und Auswertung.....	5
3. Zusammenfassung und Bewertung	14

Anlagen:

Anlage 1: Bohrprofil der Erkundungsbohrung (übermittelt GEO, redigiert durch die H.S.W. GmbH)

1. Anlass

Im Rahmen der Planung eines Erdwärmeverhabens zur saisonalen Speicherung von Solarwärme am Standort Fjernvarmvej 2, in 8740 Braedstrup (Königreich Dänemark) wurde die H.S.W. GmbH Rostock (Deutschland) durch das GEO (The Danish Geotechnical Institute) beauftragt eine in-situ-Messung der thermophysikalischen Parameter des Untergrundes mittels Geothermal Response Test (GRT) an einer bauseits hergestellten Test-Erdwärmesonde vorzunehmen.

Für die Planung und Leistungsberechnung von mittleren bis großen Anlagen zur Nutzung der oberflächennahen Geothermie sind Kenntnisse über die thermophysikalischen Eigenschaften des Untergrundes erforderlich. Im Allgemeinen kann nach Durchführung eines GRT auf Sicherheitszuschläge der konventionellen Bemessung nach Literaturwerten verzichtet werden. Zudem ermöglicht der GRT eine Absicherung der in der Vorplanung angesetzten Rechenwerte. Mittels Geothermal Response Test ist eine in-situ-Bestimmung der entscheidenden Parameter (effektive Wärmeleitfähigkeit und thermischer Bohrlochwiderstand) zur optimalen Bemessung der Erdwärmeanlage möglich.

Der Vorteil eines GRT im Vergleich zu Laboruntersuchungen an Bodenproben ist, dass die Messung bei quasi ungestörten Untergrundverhältnissen über die gesamte Erdwärmesondenlänge durchgeführt wird und thermische Einflüsse des Verpressmittels, die technische Qualität der Erdwärmesonde bzw. des Sondeneinbaus und die Grundwasserströmung mit in die Messung eingehen. Die Test-Erdwärmesonde steht nach Beendigung des GRT für eine uneingeschränkte Nachnutzung zur Verfügung.

Die Herstellung der Test-Erdwärmesonde erfolgte am 09.03.2010.

Der mittlere Bohrlochdurchmesser betrug bis zur Endteufe der Bohrung (50 m) ca. 10 Zoll (ca. 254 mm). Für den Ausbau der Bohrung kam eine werksgefertigte Doppel-U-Erdwärmesonde (Fabrikat Rehau PE-Xa, 32 x 2,9 mm) zum Einsatz. Als Verfüllmaterial des Bohrlochringraumes wurde Quarzsand verwendet.

Die Einbautiefe der Test-Erdwärmesonde wurde durch die H.S.W. GmbH im Zuge der Lotung mittels TLC-Meter bis 45 m nachgewiesen.

Das geologische Schichtenprofil wurde durch einen Fachgeologen der GEO (The Danish Geotechnical Institute) vor Ort aufgenommen und der H.S.W. GmbH übergeben. (siehe Anlage 1).

Die prozentualen Anteile der Substrate des erbohrten Profils bis zur Ausbautiefe der Test-Erdwärmesonde stellen sich gemäß dem aufgenommenen Schichtenprofil wie folgt dar:

- ca. 4 % Ton/Schluff,
- ca. 40 % Lehm,
- ca. 56 % Sand.

Die erbohrten Substrate können aufgrund der gesteinsphysikalischen Eigenschaften sowie variierender Wassergehalte erhebliche Unterschiede in der Wärmeleitfähigkeit aufweisen. Des Weiteren können regionale Unterschiede der scheinbaren bzw. effektiven Wärmeleitfähigkeit aufgrund eines zusätzlich lateralen Wärmetransportes durch das Grundwasser auftreten.

Der Grundwasserspiegel wurde im Zuge der Bohrung bei 49 m unter GOK nachgewiesen.

In der VDI-Richtlinie 4640 sowie in der Datenbank der Geosoftware Earth Energy Designer (EED) werden für die einzelnen Substrate entsprechende Wärmeleitfähigkeiten angegeben u.a. für:

- Geschiebelehm/Geschiebemergel zwischen 1,10 und 2,90 W/(m·K),
- Ton/Schluff zwischen 0,40 - 1,00 W/(m·K) (trocken) und zwischen 1,10 - 3,10 W/(m·K) (wassergesättigt),
- Sand zwischen 0,30 - 0,90 W/(m·K) (trocken) und zwischen 2,00 - 3,00 W/(m·K) (wassergesättigt).

Der Geothermal Response Test begann am 27.04.2010. Die Phase der Wärmeeinspeisung wurde über einen Zeitraum von ca. 72 Stunden durchgeführt.

Zur Mindest-Messdauer eines Geothermal Response Tests werden Empfehlungen von 48 bzw. 50 h gegeben [u.a. Sanner, B. (2001)].

Das Mindestzeitkriterium für die Auswertung eines Geothermal Response Test, welches Auswertedifferenzen infolge ggf. auftretender Messstörungen reduzieren soll, lautet:

$$t > (5r_b^2)/a \rightarrow t > \text{ca. } 12 \text{ h}$$

Hierbei ist t die Startzeit des zur konventionellen Auswertung (stationäre Betriebsphase) herangezogenen Zeitraumes.

Bei der Durchführung des GRT kam ein mobiles GRT-Gerät mit spezieller speicherprogrammierbarer Steuerung (SPS) zum Einsatz. Die Temperaturmessung erfolgte während der gesamten Testzeit am Vor- und Rücklauf der Sonde an der GRT-Testeinheit.

Im Zuge der Auswertung des Geothermal Response Tests sollten die Parameter:

- lokale effektive Wärmeleitfähigkeit λ_{eff} und
- lokaler thermischer Bohrlochwiderstand R_b bestimmt werden.

Die Wärmeleitfähigkeit beschreibt das Wärmetransportvermögen mittels Wärmeleitung (Konduktion) im Untergrund. Sie wird im Wesentlichen vom anstehenden Gestein und dessen Wassersättigung bestimmt. Kann sich Grundwasser frei bewegen, so ist zusätzlich ein lateraler Wärmetransport gegeben. Die effektive Wärmeleitfähigkeit berücksichtigt sowohl den konduktiven, als auch den lateralen Wärmetransport. Die Einheit für die effektive Wärmeleitfähigkeit wird in $W/(m \cdot K)$ angegeben.

Der thermische Bohrlochwiderstand ist ein Maß für die Temperaturdifferenz, die infolge des Wärmestroms vom Gebirge zum Wärmeträgerfluid in der Sonde bzw. umgekehrt entsteht und wird in $K/(W/m)$ angegeben. Der thermische Bohrlochwiderstand setzt sich aus folgenden Komponenten zusammen: den Übergangswiderständen 1. Erdreich \rightarrow Ringraumverpressung; 2. Ringraumverpressung \rightarrow Rohr; 3. Rohr \rightarrow Wärmeträgerfluid und aus den Materialwiderständen: 1. Verpressmaterial und 2. Rohrmaterial.

Der thermische Bohrlochwiderstand verhält sich umgekehrt proportional zur Wärmeleitfähigkeit, d.h. je höher die Wärmeleitfähigkeit der Bohrlochinstallation (Verfüllung,

Sondenmaterial), desto kleiner ist der Wärmewiderstand. Der per Geothermal Response Test gemessene thermische Bohrlochwiderstand beschreibt somit die thermische Qualität der Installation einer Erdwärmesonde.

2. Testdurchführung und Auswertung

Eine Übersicht der Sonden- und Bohrlochparameter der Test-Erdwärmesonde gibt nachfolgende Tabelle:

Teufe: (Bohrung/Erdwärmesonde)	50 m/45 m
Ausbau:	PE-Xa, Doppel-U-Erdwärmesonde (32 x 2,9 mm)
Bohrlochdurchmesser:	im Mittel 254 mm
Verfüllungsmaterial:	Quarzsand
Durchgang	keine Beanstandung
Testdatum:	Beginn: 27.04.2010 ca. 18:30 Uhr
Testverfahren:	Wärmeeinspeisung ca. 3,8 kW
Testausrüstung:	mobiles GRT-Gerät mit SPS (H.S.W. GmbH) Baujahr 2008
Messfühler:	Pt100, IDM



Abbildung 1: GRT-Einheit am Messstandort in Braedstrup, Fjernvarmvej 2

Zur **Bestimmung der mittleren Gebirgstemperatur** wurde am 27.04.2010 in der Test-Erdwärmesonde eine Temperatur-Profilmessung mit einem TLC-Meter durchgeführt. Im Ergebnis der Temperatur-Profil-Messung stellte sich ein Temperatur-Teufen-Verlauf gemäß dem Diagramm 1 dar.



Diagramm 1: Temperatur-Teufen-Verlauf nach Temperaturmessung mittels TLC-Meter

Von der Oberfläche bis ca. 30 m Tiefe ist der Temperaturverlauf durch saisonale Einflüsse (Wirkung klimatischer Randbedingungen, Strahlung, ggf. Niederschlag - hier: Frühjahr und Winter) gekennzeichnet.

Von 30 m bis zur Messentiefe von 45 m wurde eine Gebirgstemperatur im Bereich zwischen 8,0...8,1 °C nachgewiesen.

Das Temperaturprofil bis zur Messtiefe von 45 m weist eine momentane mittlere Gebirgstemperatur von ca. 8,13 °C vor Beginn der Messung aus.

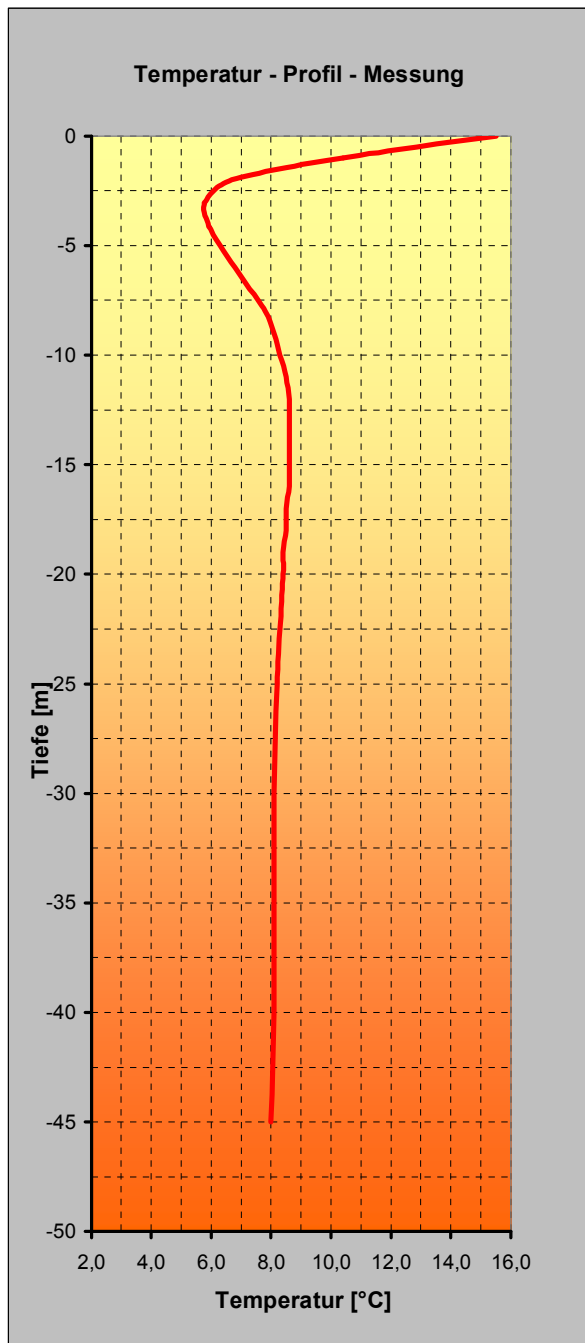
Aus dem gemessenen Temperaturverlauf bis 45 m unter GOK ist kein natürlicher geothermischer Gradient ableitbar.

Die Fluid-Temperaturen (im Vor- und Rücklauf der GRT Test-Einheit) wurden zu Beginn der Messung bei der Start-Zirkulation (Phase der Umwälzung des Fluids vor Wärmeeinspeisung) an der Sonde bei durchschnittlich 8,18 °C gemessen (Diagramm 2).

Die im Zuge der Tiefen-Profil-Messung nachgewiesene mittlere Gebirgstemperatur wurde somit bestätigt.



Diagramm 2: Messung der Fluidtemperatur vor GRT- Beginn

Der Geothermal Response Test an der Test-Erdwärmesonde in Braedstrup wurde am 27.04.2010 um ca. 18:30 Uhr begonnen.

Das Diagramm 3 zeigt den Temperaturverlauf während der Wärmeeinspeisung sowie die eingebrachte Heizleistung. Die Temperaturganglinien (Vorlauf- und Rücklauf-temperatur) erreichten sehr schnell einen einheitlich parallelen Verlauf (ΔT_i).

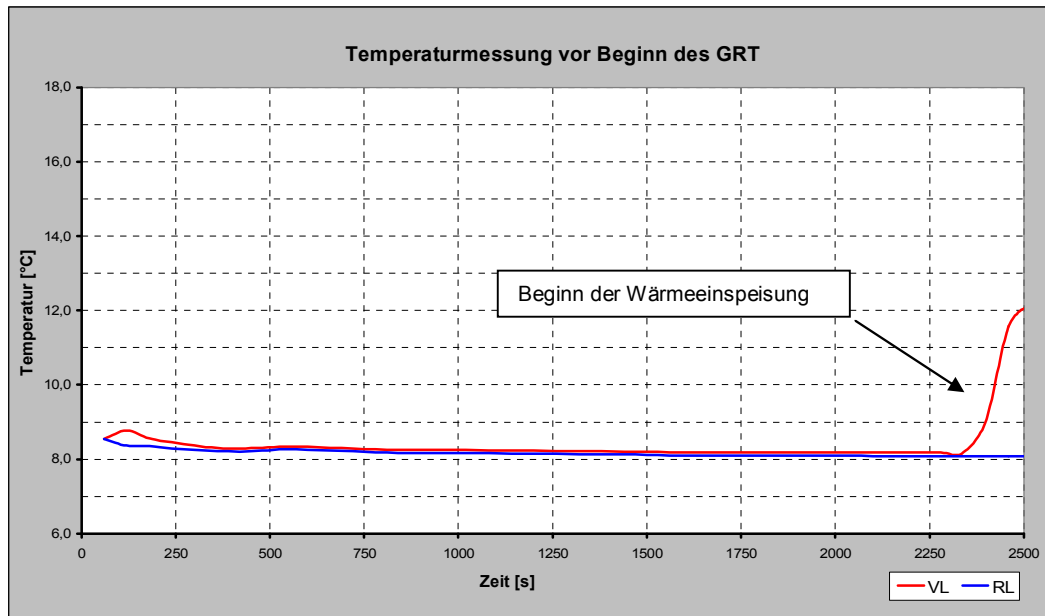

Diagramm 3: Temperaturverlauf Fluid und Heizleistung während der Wärmeeinspeisung

*Erläuterung: [TVL] Vorlauftemperatur, [TRL] Rücklauftemperatur und [T mid] mittlere Fluidtemperatur

Die eingebrachte Heizleistung wurde während der gesamten Wärmeeinspeisung auf durchschnittlich 3,8 kW geregelt. Bei der Aufzeichnung der gemessenen Temperaturen stellte sich nach ca. 12 Stunden Betrieb ein stetig steigender Verlauf der Temperaturganglinien ein (semilogarithmische Darstellung der stationären Betriebsphase, siehe Diagramm 4).

Die konventionelle Auswertung eines GRT erfolgt nach der Kelvin'schen Linienquellentheorie [u.a. Hellström, G. (1991 - 1994), Gehlin, S. (1996 - 2000)]:

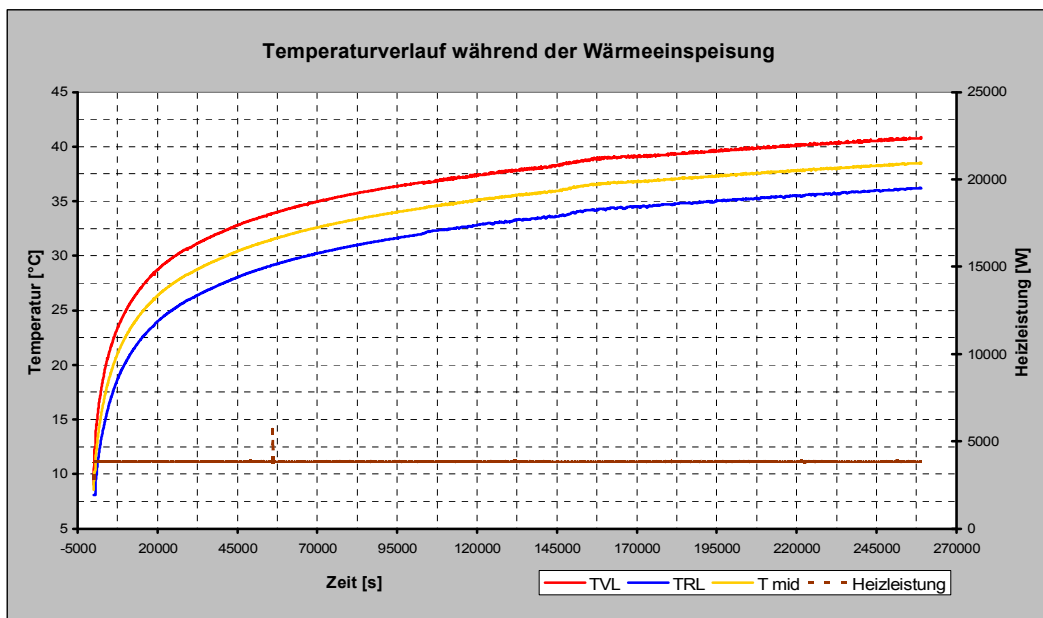
$$Gl. 1 \quad T_f = \frac{\dot{Q}}{4 \cdot \pi \cdot \lambda \cdot H} \cdot \ln(t) + \left[\frac{\dot{Q}}{H} \left(\frac{1}{4 \cdot \pi \cdot \lambda} \cdot \left[\ln \left(\frac{4 \cdot \alpha}{r_0^2} \right) - \gamma \right] + R_b \right) + T_s \right]$$

mit:

T_f	mittlere Fluidtemperatur	[°C],	Q	Heizleistung	[W]
λ	Wärmeleitfähigkeit des Untergrundes	[W/(m·K)],	H	Tiefe der Erdwärmesonde	[m]
t	Zeit	[h],	α	Temperaturleitfähigkeit	[m ² /s]
r_0	Bohrlochradius	[mm],	γ	Euler'sche Zahl	
R_b	thermischer Bohrlochwiderstand	[K/(W/m)],	T_s	Temp. des ungestörten Untergrundes	[°C]

Grundlage der Auswertung des GRT ist der mittlere Fluid-Temperatur-Verlauf in der Erdwärmesonde während des Tests.

Im Ergebnis einer Auftragung der Messwerte der während eines GRT aufgezeichneten mittleren Fluidtemperatur auf eine logarithmische Zeitachse, kann die effektive Wärmeleitfähigkeit des Untergrundes aus der Steigung der sich ergebenden Geraden ermittelt werden. Nach Bestimmung der effektiven Wärmeleitfähigkeit kann der thermische Widerstand zwischen Fluid und Bohrlochwand (thermischer Bohrlochwiderstand) berechnet werden.

Der Verlauf der Fluidtemperatur in der stationären Betriebsphase stellt sich bei Logarithmierung der Zeitwerte für den durchgeführten Test wie im Diagramm 4 abgebildet dar.



Diagramm 4: Verlauf der Fluidtemperatur in der stationären Betriebsphase (logarithmische Zeiteinteilung) und lineare Regression

Das ermittelte Bestimmtheitsmaß von $R^2 = 0,9985$ gibt den linearen Zusammenhang zwischen der Messreihe und der Regressionsgeraden an. Demzufolge können ca. 97,8 % der Streuung der Ordinatenwerte (Y) durch lineare Abhängigkeit der Abszissenwerte (X) beschrieben werden.

Für die Auswertung der Kurvenanpassung nach „objective function“ (Anpassung der gesamten Messkurve der Aufheizung) werden der gemessene und der sich gemäß funktionalem Zusammenhang [u.a. Hellström, G.(1991 - 1994), Gehlin, S. (1996 - 2000)] ergebende mittlere Fluid-Temperatur-Verlauf gegenübergestellt (siehe Diagramm 5) und die gesuchten Parameter durch Kurvenanpassung nach dem „best fit“ ermittelt. Die Anpassung der „fitting curve“ erfolgte nach der „objective function“ über den Messzeitraum der Aufheizung nach dem Kriterium: Summe der Abweichungsquadrate $\rightarrow 0$.

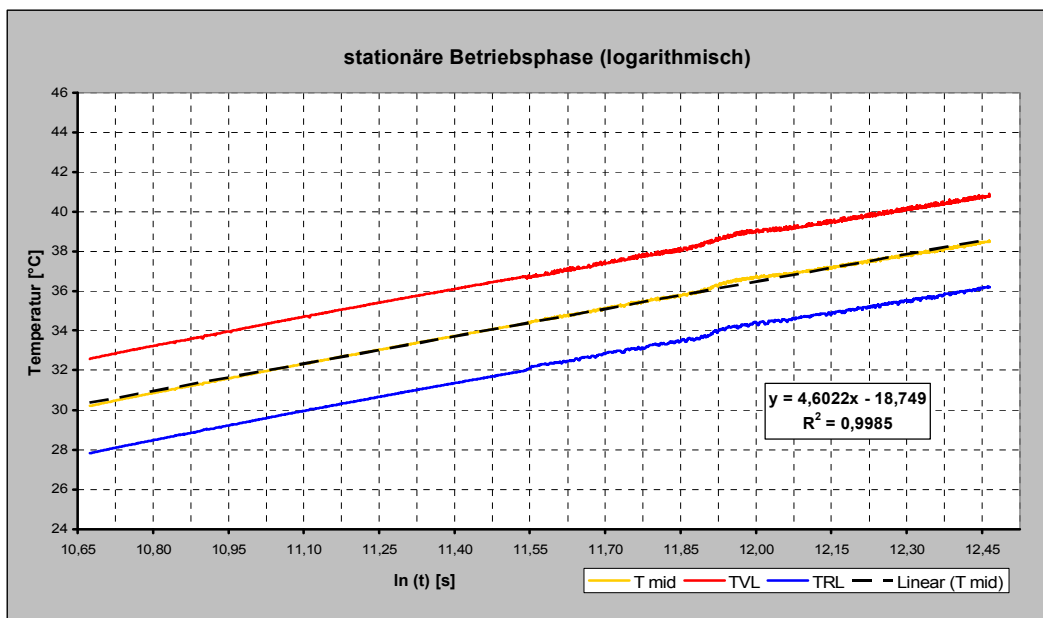

Diagramm 5: Vergleich gemessene mittlere Fluidtemperatur und fitting curve

Die Abweichung der gemessenen Fluidtemperaturen von der „fitting curve“ wird im Diagramm 6 dargestellt.

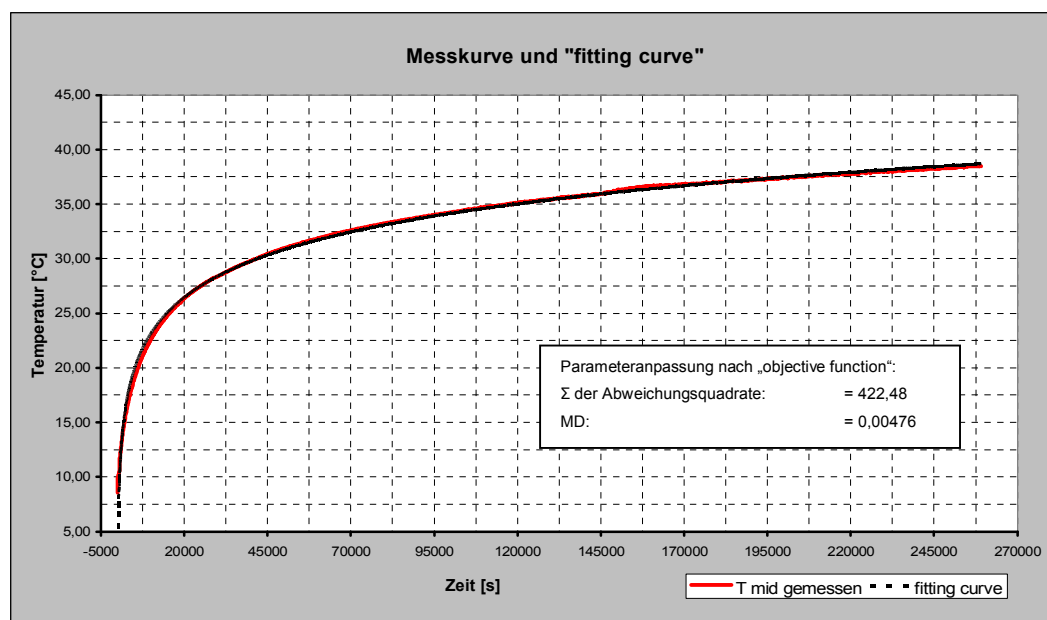

Diagramm 6: Abweichung der Messwerte von der fitting curve

Im **Ergebnis** der Auswertung des GRT wurden nachfolgende thermophysikalische Parameter für das Gesamtprofil ermittelt:

Auswertung	effektive Wärmeleitfähigkeit λ_{eff}	thermischer Bohrlochwiderstand R_b
konventionell (Auswertung der stationären Betriebsphase)	1,47 W/(m·K)	0,176 K/(W/m)
„objective function“ (Auswertung des gesamten Temperaturanstiegs)	1,42 W/(m·K)	0,172 K/(W/m)

Die spezifische Wärmekapazität wurde in den Berechnungen als gewichtetes Mittel entsprechend dem Verhältnis der anstehenden Substrate mit $c = 1,9 \text{ MJ}/(\text{m}^3 \cdot \text{K})$ angesetzt.

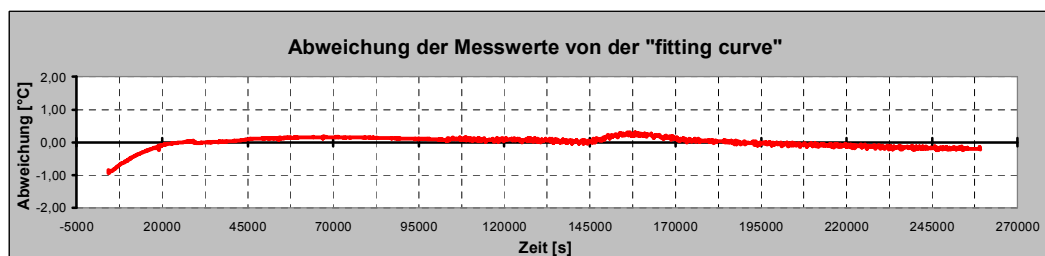
Für die weitere Bemessung des Erdwärmesondenfeldes wird bei einer Einheitstiefe von ca. 45 m die Verwendung der effektiven Wärmeleitfähigkeit von $\lambda_{\text{eff}} = 1,42 \text{ W}/(\text{m} \cdot \text{K})$ empfohlen. Dieser Wert geht aus der Auswertung nach „objective function“ hervor.

Der thermische Bohrlochwiderstand kann unter Berücksichtigung adäquater Ausbauparameter für die Erdwärmesonden des Erdwärmesondenfeldes (hier: Verfüllung mit Quarzsand, Doppel-U-EWS 32 mm, Durchmesser der Bohrung 254 mm u.a.) mit $R_b = 0,172 \text{ W}/(\text{K}/\text{m})$ für weitere Berechnungen zugrunde gelegt werden.

Anhand der **Darstellung der Fehlerabschätzung** ist der Einfluss von Abweichungen der verwendeten Eingangparameter im Bezug auf die sich einstellenden Bemessungsergebnisse dokumentiert. Grundlage der Fehlerabschätzung ist die Parameteranpassung nach „objective function“.

Bemessungsparameter	Mess-/ Erwartungswert	Abweichung vom Mess- /Erwartungswert	Ergebnis λ_{eff} [W/(m·K)]	Ergebnis R_b [K/(W/m)]
Sondenlänge	45 m	+ / - 1 %	1,40 / 1,43	0,175 / 0,170
Bohrlochdurchmesser	Ø 254 mm	+ / - 10 %	kein Einfluss	0,183 / 0,160
Heizleistung	3,8 kW	+ / - 5 %	1,49 / 1,35	0,161 / 0,184
ungestörte Erdreich- temperatur	8,13 °C	+ / - 10 %	kein Einfluss	0,163 / 0,182
geschätzte spezifische Wärmekapazität des Erdreichs	2,5 MJ/(m³K)	+ / - 10 %	kein Einfluss	0,178/ 0,166



Diagramm 7: Temperatur-Teufen-Verlauf gemäß Temperaturmessung mittels TLC-Meter

Nach Beendigung des GRT wurde am 03.05.2010 um 14:00 Uhr (ca. 116 Stunden nach Abschalten der Wärmeinjektion) eine erneute Temperatur-Profil-Messung mittels TLC- Meter durchgeführt.

Die Temperaturverläufe vor und nach dem GRT sowie das schematisierte Bohrerprofil sind im Diagramm 7 gegenübergestellt.

Über die die gesamte Tiefe ist eine geringfügig voneinander abweichende thermische Wiederangleichung an die ursprüngliche Gebirgstemperatur ersichtlich. Dies zeigt geringe Unterschiede der effektiven Wärmeleitfähigkeit im Bohrerprofil an.

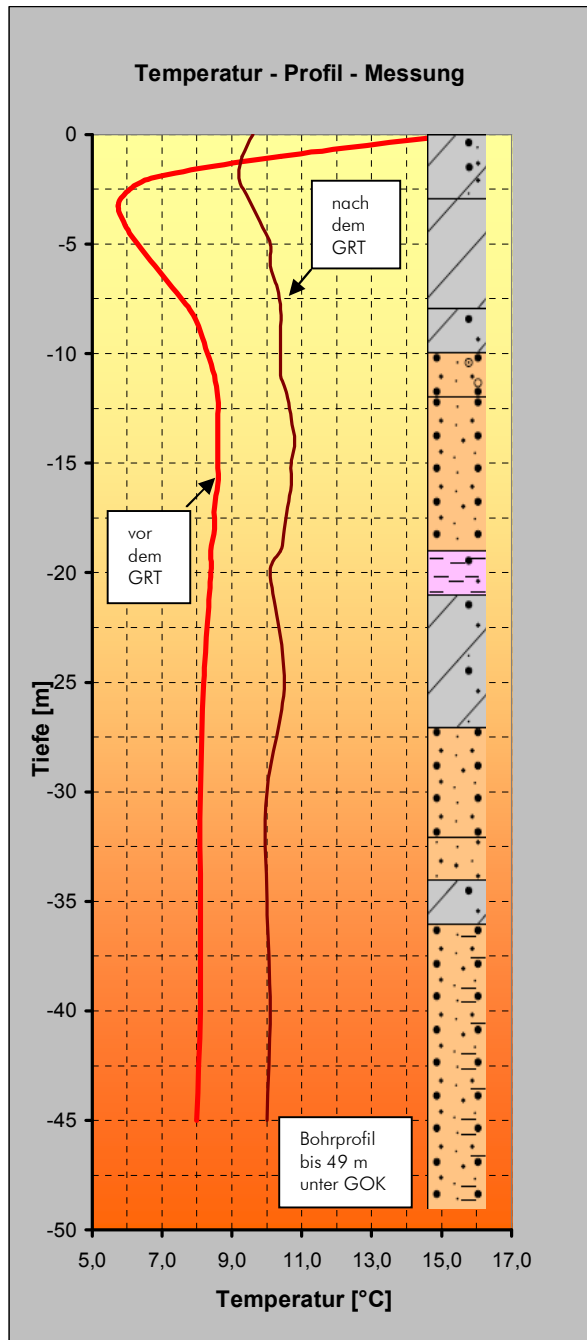
3. Zusammenfassung und Bewertung

Im Rahmen der Planung eines Erdwärmeverhabens zur saisonalen Speicherung von Solarwärme am Standort Fjernvarmvej 2, in 8740 Braedstrup (Königreich Dänemark) wurde im Auftrag des GEO (The Danish Geotechnical Institute) eine in-situ-Messung der thermophysikalischen Parameter des Untergrundes mittels Geothermal Response Test (GRT) vorgenommen.

Die Auswertung des Geothermal Response Tests zur Ermittlung der effektiven Wärmeleitfähigkeit und des thermischen Bohrlochwiderstandes erfolgte

1. nach der konventionellen Methode für die stationäre Betriebsphase,
2. als Kurvenanpassung nach „objective function“ für die gesamte Phase der Wärmeeinspeisung.

Der GRT führte zu plausiblen Werten der effektiven Wärmeleitfähigkeit von ca. $1,42 \text{ W}/(\text{m}\cdot\text{K})$ und des thermischen Bohrlochwiderstandes von $0,172 \text{ K}/(\text{W}/\text{m})$.

Die mittels GRT bestimmte effektive Wärmeleitfähigkeit für die getestete Erdwärmesonde repräsentiert mit $1,42 \text{ W}/(\text{m}\cdot\text{K})$ den oberen Erwartungswert der gemäß VDI-Richtlinie 4640 angegebenen integrierten Wärmeleitfähigkeit für das erbohrte Profil über die gesamte Tiefe (hier: vornehmlich trockene bis erdfeuchte Substrate). Der gemessene Wert erscheint plausibel.

Der gemessene thermische Bohrlochwiderstand ist repräsentativ für die Bauart und Qualität der Ringraumverfüllung/Sondeninstallation.

Dipl.-Ing. T. Hanschke
(Fachgruppenleiter Geothermie)

Dipl.- Ing. Jens-Uwe Kühl
(Bearbeiter)

Literatur:

Chiasson, A. - Advances in Modelling of Ground-Source Heat Pump Systems. Dissertation Oklahoma State University, 1999

Eugster, W.J. und Laloui, L. - Workshop „Geothermische Response Tests“, Geothermische Vereinigung e.V. 49744 Geeste, 2002

Gustafson, A.-G. - Thermal Response Test - Numerical simulations and analyses, Lulea University of Technology, 2006

Gehlin S. - Thermal Response Test - In Situ Measurements of Thermal Properties in Hard Rock, Licentiate Thesis, Lulea 1998

Hanschke, Th. & Freund, R. Geothermal Response Tests mit geregelter Wärmeeintrag - erste Betriebserfahrungen mit der neuen GRT-Messeinheit. 9. Geothermische Fachtagung Karlsruhe, Oktober 2006

Untersuchungsberichte Geothermal Response Test (u.a.):

- IC Roggentin (2003)
- Silo 4 + 5 Rostock, Test an EWS und Energiepfahl (2003)
- Bürogebäude Rostock, Doberaner Platz (2004)
- HDPG Rügen (2004)
- Universitätsbibliothek Rostock (2004)
- Spredreieck Berlin-Mitte (2006)
- Ecopark Emsteck (2006)
- Reedereigebäude Beluga in Bremen (2006)
- Gebäude für altersgerechtes Wohnen in Teterow (2007)
- Friedrich-Franz-Bahnhof Rostock (2007)
- Ärztehaus Leer (2007)
- ZOO Frankfurt am Main (2007)
- Hamburg Sandtorpark (2007) u.a.
- Ahlbeck auf Usedom - Ostseeresidenz (2007)
- List auf Sylt - Naturgewalten (2007)
- MaritimHotel - Heringsdorf (2007)
- WAZ - Mahlow-Blankenfelde (2008)
- Altstadtchule - Wedel (2008)
- Oberstufenzentrum - Lübben und Königs-Wusterhausen (2008)
- Deichmann - Essen (2008)
- Grundschule Juillac Frankreich (2009)
- Katholisches Heim Zagreb Kroatien (2009)

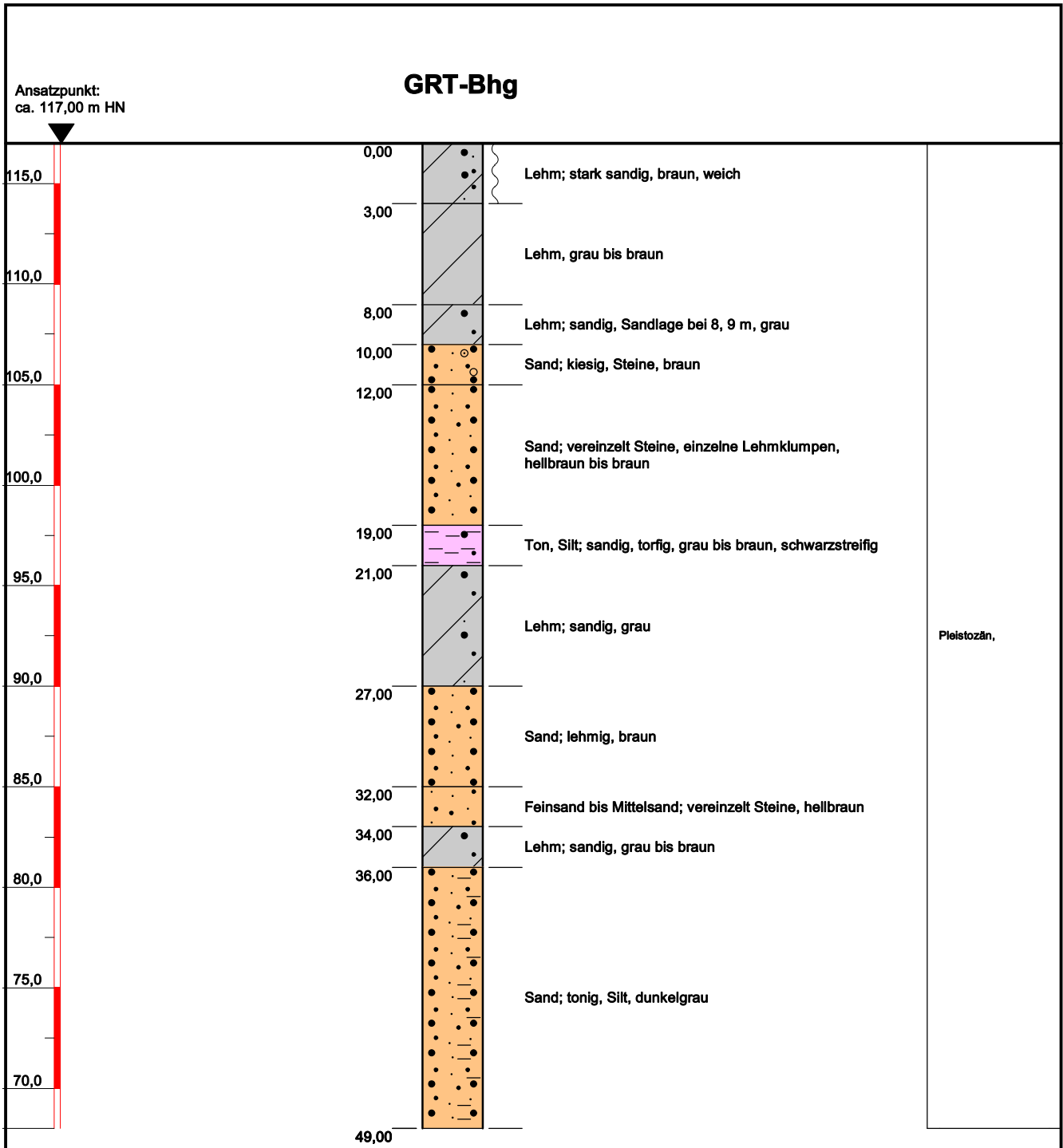

Bemerkungen:
Höhenmaßstab: 1:300, Koordinatensystem: RD/83 (Bessel)

Projekt: Braedstrup, Fjernvarmevej 2		 H.S.W. GmbH Ingenieurbüro für Angewandte und Umweltgeologie Gerhart-Hauptmann-Straße 19 D-18055 Rostock Tel. 0381.37015 / Fax 0381.31224 email: hsw.ingbuero@t-online.de
Bohrung: Braedstrup-GRT-04/010 (GRT-Bhg)		
Auftraggeber: GEO Brabrand	Rechtswert: 3539170	
Bohrfirma: GEO Brabrand	Hochwert: 6205900	
Bearbeiter: J.-U. Kühl	Ansatzhöhe: 117,00 m	
Datum: 27.04.2010	Endteufe: 49,00 m	

ANNEX 4

Borehuller i Brødstrup

PlanEnergi, den 28. juli 2010 / nf

Pilot-projekt	Tin °C	Tout °C	m kg/h	Q kJ/h	m m ³ /h	Q kW	
Loop 1	Max.	35	95	233.293	-828.223	233	-230
	Middel	34	58	99.850	-7.779.426	100	-2.161
	Min.	33	34	17.363	-25.961.710	17	-7.212
Loop 2	Max.	95	90	7.203.354	60.901.578	7.203	16.917
	Middel	63	45	189.745	7.887.535	190	2.191
	Min.	35	33	0	-892.668	0	-248
Loop 3	Max.	23	28	139.756	0	140	0
	Middel	10	15	6.922	-144.671	7	-40
	Min.	5	10	0	-2.920.855	0	-811
Loop 4	Max.	70	26	25.000	1.105.345	25	307
	Middel	33	12	13.156	136.357	13	38
	Min.	10	7	0	0	0	0
Loop 5	Max.	70	95	25.000	0	25	0
	Middel	33	58	3.150	-183.078	3	-51
	Min.	10	34	0	-1.982.111	0	-551
BTES	Max.	75	70	25.000	1.986.906	25	552
	Middel	42	33	18.886	46.639	19	13
	Min.	8	10	0	-1.109.218	0	-308
HP_CS	Max.	28	23	139.759	2.927.911	140	813
	Middel	15	10	6.922	145.018	7	40
	Min.	10	5	0	0	0	0
HP_WS	Max.	90	100	46.262	3.944.075	46	1.096
	Middel	45	81	1.282	222.086	1	62
	Min.	33	80	0	0	0	0

Max, middel og min-værdierne er beregnet ud fra 8760 årlige timeværdier, excl. de 24 højeste og laveste værdier.

Loop 1, 2, 3, 4 og 5 er flow ind og ud af ståltankene.

Loop 1: Fjernvarme fra / til by

Loop 2: **Summen af** varme fra solfangere, motor og varmepumpens varme side
Flowet i loop 2 skal være meget mindre end den opgivne max-værdi
(nogle få årlige timeværdier er beregningsteknisk meget høje).

Loop 3: Varmepumpens kolde side

Loop 4: Afladning af BTES

Loop 5: Opladning af BTES

BTES: Borehole Thermal Energy Storage

HP_CS og HP_WS er varmepumpens kolde og varme side.

Borehuller i Brødstrup

PlanEnergi, den 28. juli 2010 / nf

Fuldskala-projekt	Tin °C	Tout °C	m kg/h	Q kJ/h	m m ³ /h	Q kW	
Loop 1	Max.	35	125	233.293	-3.021.462	233	-839
	Middel	34	73	94.350	-11.542.069	94	-3.206
	Min.	33	38	11.393	-27.905.052	11	-7.751
Loop 2	Max.	121	97	7.519.451	108.969.786	7.519	30.269
	Middel	72	52	289.612	13.001.034	290	3.611
	Min.	39	33	0	-2.126.863	0	-591
Loop 3	Max.	45	50	773.607	0	774	0
	Middel	16	21	62.852	-1.312.594	63	-365
	Min.	5	10	0	-16.150.060	0	-4.486
Loop 4	Max.	73	48	228.000	8.465.934	228	2.352
	Middel	47	18	119.979	1.576.103	120	438
	Min.	13	7	0	0	0	0
Loop 5	Max.	73	125	228.000	0	228	0
	Middel	47	73	24.256	-1.911.478	24	-531
	Min.	13	38	0	-17.518.587	0	-4.866
BTES	Max.	76	73	228.000	17.560.596	228	4.878
	Middel	49	47	206.752	330.816	207	92
	Min.	8	13	0	-8.479.563	0	-2.355
HP_CS	Max.	50	45	773.637	16.200.000	774	4.500
	Middel	21	16	62.878	1.316.302	63	366
	Min.	10	5	0	0	0	0
HP_WS	Max.	97	107	247.593	19.440.000	248	5.400
	Middel	52	82	9.760	1.629.501	10	453
	Min.	33	80	0	0	0	0

Max, middel og min-værdierne er beregnet ud fra 8760 årlige timeværdier, excl. de 24 højeste og laveste værdier.

Loop 1, 2, 3, 4 og 5 er flow ind og ud af ståltankene.

Loop 1: Fjernvarme fra / til by

Loop 2: Summen af varme fra solfangere, motor og varmepumpens varme side
Flowet i loop 2 skal være meget mindre end den opgivne max-værdi
(nogle få årlige timeværdier er beregningsteknisk meget høje).

Loop 3: Varmepumpens kolde side

Loop 4: Afladning af BTES

Loop 5: Opladning af BTES

BTES: Borehole Thermal Energy Storage

HP_CS og HP_WS er varmepumpens kolde og varme side.



ANNEX 6

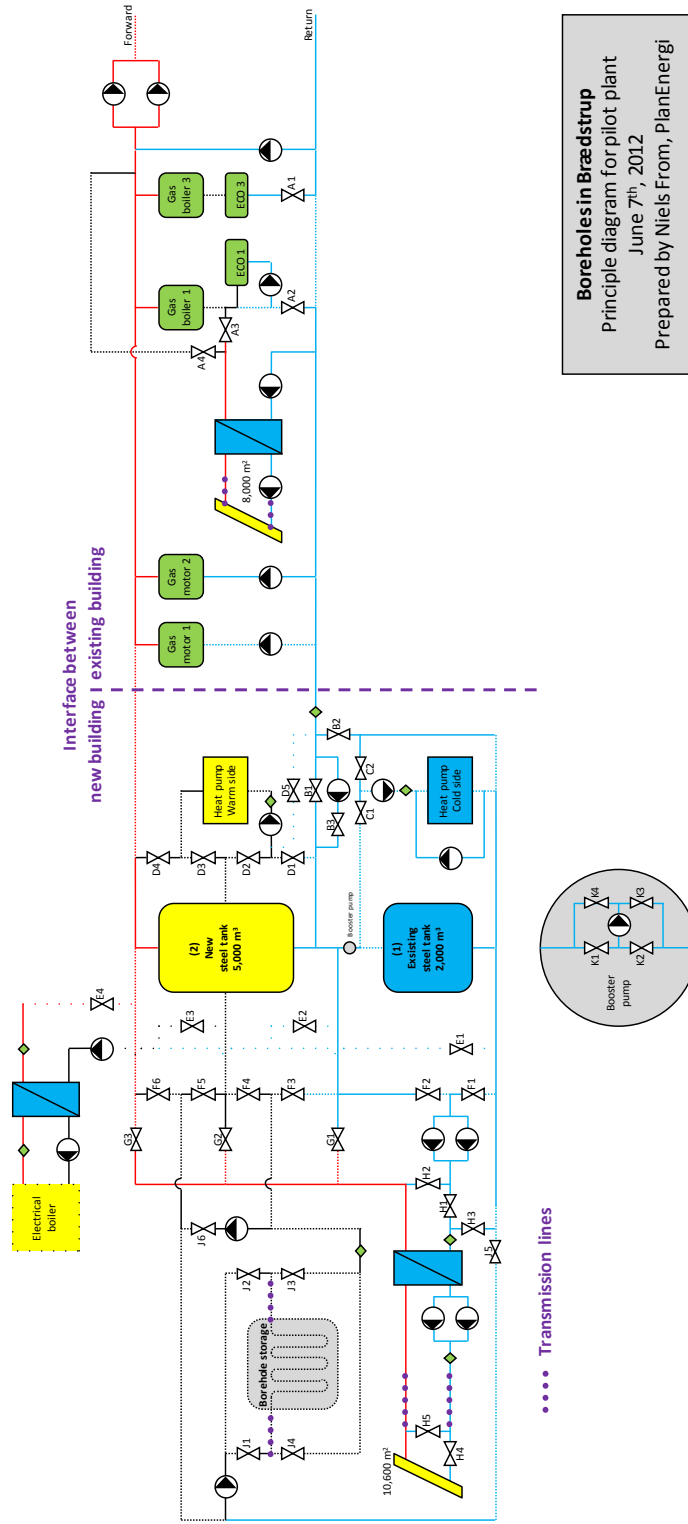

Boreholes in Brædstrup
 Principle diagram for pilot plant
 June 7th, 2012
 Prepared by Niels From, PlanEnergi

Notat

Vedr.: Borehuller i Brædstrup
Kontrol af varmepumpens ydelse og COP

Dato: 7. juni 2013

Indledning

Undertegnede har modtaget målinger for varmepumpen den 31/1-2013.

I nærværende Notat er de modtagne målinger anvendt til en kontrol af varmepumpens ydelse og COP.

Garanti

Garantien er beskrevet i kontrakten mellem Brædstrup Totalenergianlæg og JCI, dateret 11/10-2011. Heraf fremgår bl.a. følgende:

7. Efter den under punkt 6 nævnte testperiode overgår ejendomsretten over aggregatet til Brædstrup Totalenergianlæg mod betaling af DKK (...) excl. moms inden 30 dage efter udløb af den under punkt 6 nævnte periode. Brædstrup Totalenergianlæg har dog ret til at undlade at overtage aggregatet, såfremt Field testen viser, at totalydelsen eller COP-værdierne er ringere end 85% af det angivne i i eksempel 2 i vedlagte beskrivelse, hvor den optagne el-effekt er incl. frekvensomformeren. Køleydelsen og COP-værdierne under driftsbetingelserne i eksempel 2 beregnes af PlanEnergi på baggrund af de data der logges af Brædstrup Totalenergianlæg under fieldtesten.”

samt

Eksempel 2

Fordamper:

Tilgangstemperatur: 25°C

(Afgangstemperatur = 22,1°C)

Volumenstrøm: 245 m³/h

Kondensator:

Tilgangstemperatur: 40°C

Afgangstemperatur: 80°C

Beregnete værdier:

Kondenseringstemperatur: 75°C

Køleeffekt: 815 kW

Afgivet effekt: 1121 kW

Effekt optaget af kompressor incl VSD: 318 kW

Massestrøm opvarmet medie: 6.54 kg/s

(= 24,0 m³/h)

Udvælgelse af data

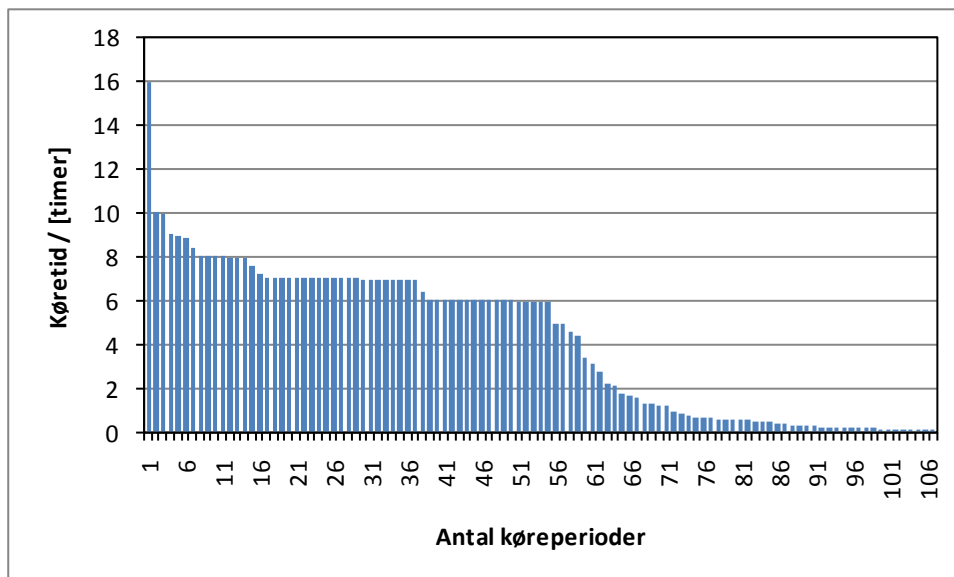

Figur 2: Varighedskurve for driftstiderne.

Den samlede driftstid har været ca. 450 timer fordelt på 107 køreperioder, hvoraf én har været på 16 timer, 54 stk. har været mellem 6 og 10 timer og de resterende 52 mellem 0 og 6 timer, jf. figur 2.

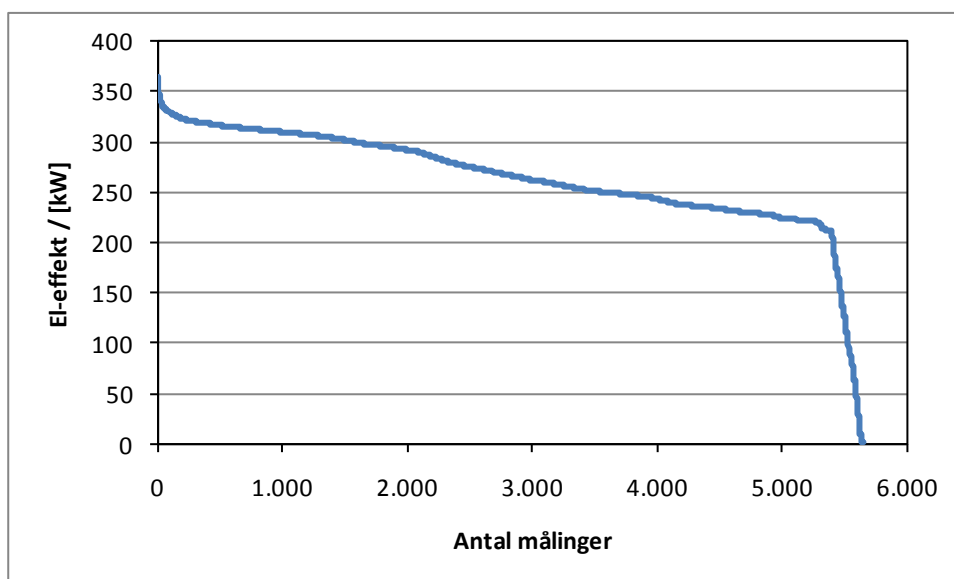

Figur 3: Varighedskurve for den optagne el-effekt.

Figur 3 viser en varighedskurve for den optagne el-effekt. Effekten er > 0 kW i 5.657 (16%) af de 36.287 målinger. I 5.404 målinger er effekten ≥ 210 kW.

Det er valgt udelukkende at bruge målinger der opfylder følgende kriterier:

- $P \geq 210$ kW
- Dato > 28/11-2012 (fordi varmepumpen er blevet optimeret forud for denne dato)
- Kompressor ≥ 6.000 rpm
- Shunt ≥ 50 Hz & SP ≥ 50 Hz
- $74^{\circ}\text{C} < \text{Kondenseringstemperatur} < 76^{\circ}\text{C}$
- Koldt flow ≥ 75 m³/h

Hermed reduceres antallet af målinger til 464 stk., svarende til knap 39 timers drift.

Resultater

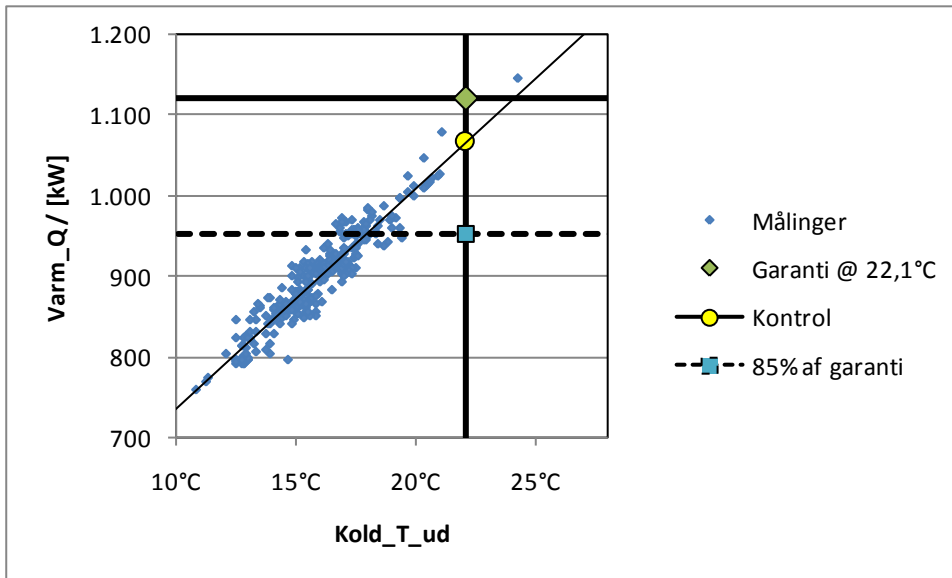

Figur 4: Garanteret og målt varmeydelse som funktion af T_{kold_ud} .

Figur 4 viser den garanterede varmeydelse og den målte ydelse.

Med målingerne efter den 28/11-2012 er ydelsen målt til 1.068 kW svarende til 95,3% af garanti-
en på 1.121 kW, og således over mindstekravet på 85%.

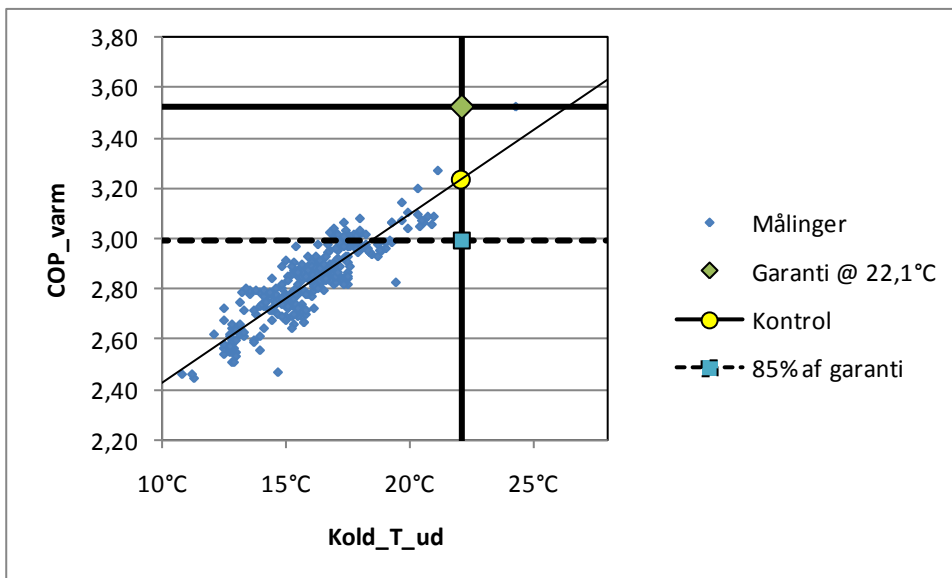

Figur 5: Garanteret og målt COP som funktion af T_{kold_ud} .

Figur 5 viser den garanterede COP og den målte COP.

Med målingerne efter den 28/11-2012 er COP målt til 3,23 svarende til 91,5% af garantien på 3,53, og således over mindstekravet på 85%.

Konklusion

Det fremgår af Figur 4 og teksten til denne, at **ydelsesgarantien ER opfyldt.**

Det fremgår tilsvarende af Figur 5 og teksten til denne, at **COP-garantien ER opfyldt.**



Brædstrup SolPark

Hovedelementerne i projektet:

- **Solvarme**
Som supplement til de 8.000 m², der blev idriftsat i 2007 er etableret yderligere 10.600 m² solfangere således at det samlede solfangerareal bliver 18.600 m². Dette anlæg er pr. 1. april 2012 Europas største.
- **Ny akkumuleringstank**
Som supplement til den eksisterende akkumuleringstank på 2.000 m³ er der bygget en ny stor akkumuleringstank, der rummer 5.500 m³ vand. Den samlede akkumuleringskapacitet er nu ikke mindre end 7,5 mio. liter vand. De 2 tanke kan gemme varmen, der produceres på solvarmeanlæg, elkedel, varmepumpe og motoranlæg. Den producerede varme kan opbevares i nogle få dage – men ikke fra f.eks. sommer til vinter. Her skal anvendes en anden teknologi – nemlig sæsonvarme-lagre som f.eks. et borehulslager.
- **Borehulslager**
Der er en grænse for, hvor store solvarmeanlæg der kan etableres og tilsluttes et fjernvarmeværk. Hvis anlæggene overstiger en produktion på 15 - 20 % af årsproduktionen på et fjernvarmeværk, vil der opstå problemer med for stor en solproduktion om sommeren. Hvis der derfor skal etableres meget store solvarmeanlæg, skal varmen kunne gemmes fra sommer til vinter i såkaldte sæsonvarmelagre. Dette kan gøres i meget store underjordiske lagre med varmt vand – en slags swimmingpool med et stort isoleret låg. Men det kan også gøres uden at akkumulere vand – nemlig i såkaldte borehulslagre.

Borehuls-teknologien er ny i Danmark og er nu etableret for første gang i Brædstrup. Brædstrup Fjernvarmes borehulslager består af 48 stk. 45 m. dybe huller. Heri er indstøbt et rørsystem, der henholdsvis tilfører jorden varme fra bl.a. solvarmeanlægget om sommeren og henter varmen op fra jorden om vinteren. Ca. 19.000 m³ jord opvarmes af

solvarmeanlægget om sommeren og kan efter beregningerne hentes ind igen med et tab over et år på ca. 20 %. Tiden vil vise om beregningerne holder stik og om der skal satses på en senere udvidelse af såvel solvarmeanlæg som borehulslager.

- **El-kedel**
I den nye teknikbygning er der ligeledes installeret en ny elkedel. Denne kan optage elektricitet op til 10.000 kilowatt (svarende til 5.000 almindelige el-kedler, der bruges i husholdningen) og omdanne elektriciteten til varme, som sendes ud til varmekunderne eller som akkumuleres i akkumuleringstankene.
El-kedlen opstartes lynhurtigt når elektriciteten er meget billig og når der er for meget elektricitet i el-nettet. Dette fænomen opstår, når vindmøllerne producerer mere strøm, end der forbruges. I disse situationer skal elektriciteten sælges billigt til vores nabolande eller omdannes til varme hos f.eks. Brædstrup Fjernvarme. Vi er på denne måde med til at stabilisere el-systemet.
- **Varmepumpe**
Den installerede varmepumpe er blevet til i et udviklings-samarbejde mellem Brædstrup Fjernvarme og firmaet Johnson Controls (tidl. Sabroe) i Århus. Der er tale om en såkaldt ”ammoniak-kølet skrue-kompressor varmepumpe”. Denne er som nævnt helt ny-udviklet og formår at booste vand-temperaturen op fra borehulslageret. Det samme gælder for akkumuleringstankene således, at disse får en lav bundtemperatur og en høj toptemperatur. Herved forøges effektiviteten i solvarmeanlægget, og varmekunderne sikres en tilpas fremløbstemperatur.
Varmepumpen startes akkurat som el-kedlen når elprisen er billig og når der er for meget el i systemet.
- Den nye teknikbygning indeholder bl.a. el-kedel, varmepumpe samt rør, pumper, varmeveksler og opsamlingstank for solvarmeanlægget.

Projekt Brædstrup SolPark (Projekt ”Boreholes in Brædstrup”) og forprojektet til dette har modtaget økonomisk støtte fra Energinet.dk, EUDP og Region Midtjylland.

Bredstrup Fjernvarme



"Solvarme og sæsonvarmelagring"

- varmestyringscenter



18.600 m² solvarmeanlæg



El fra bl.a. vindmøller

Varmevæksler

Varmepumpe

Varme (ca. 40 grader)

Borekulslegår /
sæsonvarmelagring
(Gemmer varmen
fra sommer til vinter)



Varme

El-kedel



Varme

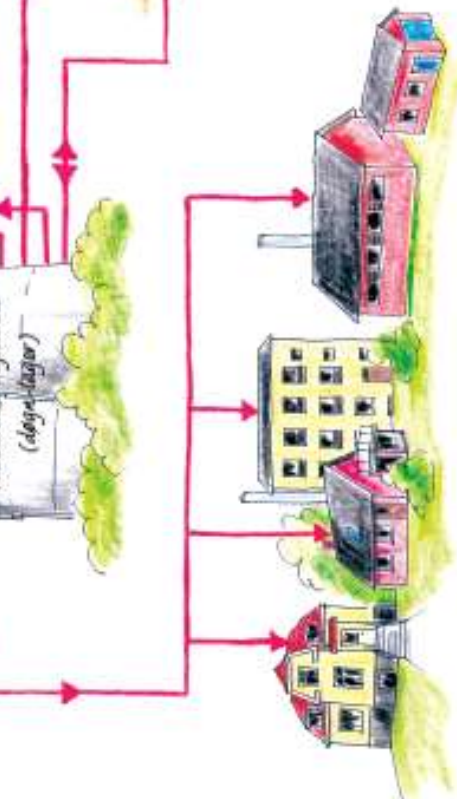

Borehulslager

- gemmer varmen fra sommer til vinter

Brædstrup Fjernvarme



Tværsnit
Borshul 30 cm
i diameter



PEX slange
32 mm i diameter

48 stk. borshuller. Hvert borshul er 45 m dybt

Grundplan

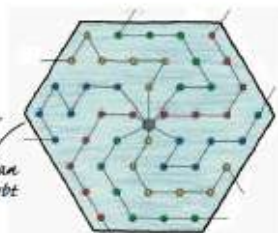

Borshulslager 24 m i diameter

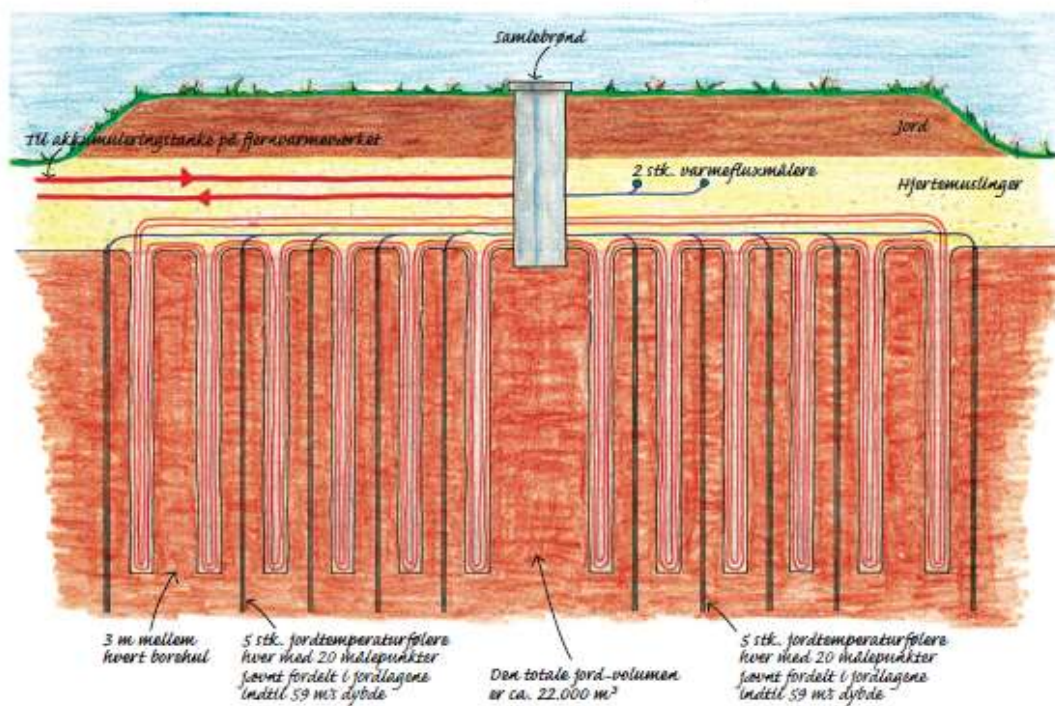

Tværsnit af isoleringslag

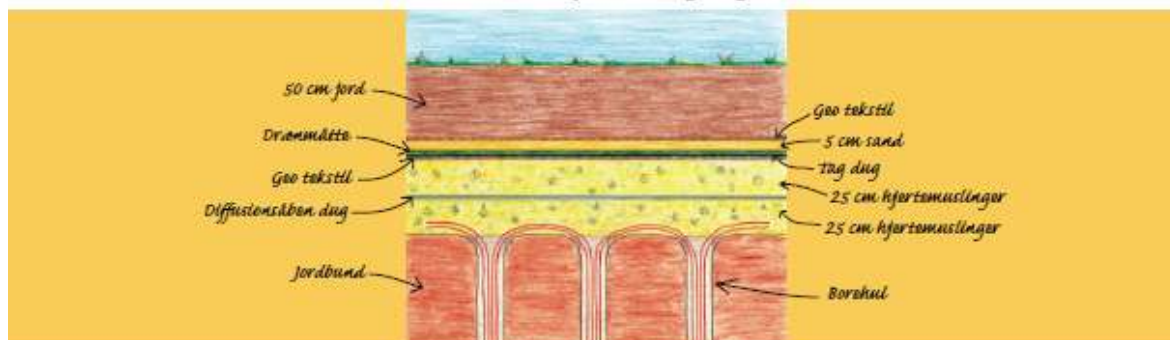

Varmeproduktionen på Brædstrup Fjernvarme måned for måned

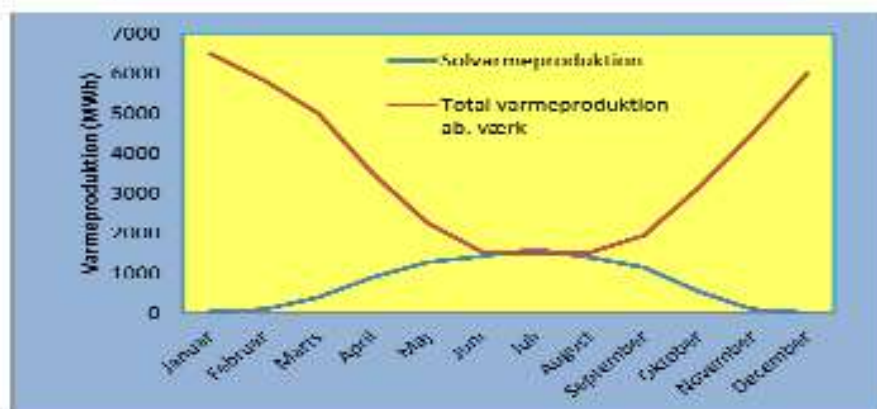

Aflæs varmeproduktionen på søjlen

På produktionssøjlen kan du se solvarmeanlæggets øjeblikkelige varmeproduktion.

Øjebliksproduktionen er anskueliggjort ved, at der for hver inddeling på søjlen er angivet hvor mange kW (kilowatt) varme, der produceres her og nu.

Derudover er vist, hvor mange nye boliger med et årsforbrug på ca. 13.500 kWh (kilowatt-timer), der kan opvarmes hele året, hvis den viste produktion er konstant et helt år.

Varmeproduktionen er aldrig konstant

Den viste produktion er naturligvis ikke konstant hele året. Der produceres som bekendt ikke varme fra anlægget om natten.

Ligeledes er produktionen begrænset, når solen er dækket af et tæt skydække.

Solvarmeanlægget producerer knap 9 mio. kWh forureningsfri varme om året – svarende til årsforbruget i ca. 700 nyere boliger.

De 9 mio. kWh svarer til ca. 20 % af Brædstrup Fjernvarmes varmeproduktion.

Af ovenstående graf kan solvarmeanlæggets varmeproduktion i forhold til den totale varmeproduktion på værket ses måned for måned.

