

TotalFlex Final Report

Document information	
Identifier:	D101-TotalFlex_report
Work Package	WP10 Demonstration
Type:	Report
Classification:	External
Version:	0.1
Date:	Dec 09 th 2016

Partnere:



conscious



AALBORG UNIVERSITET



NEAS ENERGY



zensehome

Revision history

Version	Date	Author	Reviewer	Description
0.1	1-1-2017	Project team		First edition
0.5	1-4-2017			Release for final review
1.0	7-4-2017			Release 1.0

Table of Contents

Revision history	2
Table of Contents	3
1 Introduction.....	6
1.1 Objective	6
2 General description.....	9
2.1 User story	9
2.2 Expected findings.....	9
3 WP1 – Communication infrastructure for metering and control	11
3.1 Executive summary	11
3.2 Introduction	12
3.3 Homeport (2a).....	13
3.4 Tool chain (2b)	15
3.5 Feature interactions (2c).....	16
3.6 Testing smart home software (2d)	17
3.7 Aggregation service architecture (3).....	18
3.8 References	20
4 WP2 – Intelligent detection and prediction.....	22
4.1 Introduction	22
4.2 Dataset.....	23
4.2.1 Data pre-processing.....	23
4.3 Flexibility Analysis	24
4.4 Device Level Demand Forecast.....	26
4.5 Flex-Offer generation.....	27
4.6 Market Evaluation	29
4.6.1 Effect of Flexible demand on Regulation Market	29
4.6.2 Financial Evaluation	30
4.7 Online Platform	31
4.8 Conclusion and Future Work	31
4.9 References	32
5 WP3 – Data aggregation and analysis	33
5.1 Flex-Offer Aggregation and Disaggregation.....	33
5.2 Aggregation and analysis system (ADS)	36
5.3 Deliverables	41
5.4 References	42
6 WP4 – User involvement within demand response	43

6.1	Introduction	43
6.2	Deliverable 1: State of the art analysis	43
6.3	Deliverable 2: Analysis of power consumption and production.....	44
6.4	Deliverable 3: Analysis of user awareness of power consumption	45
6.5	Deliverable 4: Functional Smartphone App	46
6.6	Deliverable 5: Demonstration of smartphone App in field trials	50
6.7	References	51
7	WP5 – Development of a grid load model and Technical VPP (TVPP).....	52
7.1	Executive summary of WP5	52
7.2	Project Objectives	53
7.3	Results and Dissemination of results.....	53
7.3.1	State-of-the-art analysis.....	53
7.3.2	Decentralised Short Term Load Forecasting.....	54
7.3.3	Estimation of Flexible Consumption.....	55
7.3.4	Load Monitoring in Low Voltage Distribution Systems	56
7.3.5	Congestion Management in Low Voltage Distribution Grids.....	57
7.3.6	Flexible Demand Management in Distribution Networks	60
7.4	Conclusions	61
7.5	References	63
8	WP6 – Development of Commercial VPP (CVPP)	64
8.1	Aggregator	64
8.2	BRP	64
8.3	CVPP functionality	64
9	WP7 – Design and development of a Market Place	68
9.1	Introduction	68
9.2	Deliverable 1: State of the art analysis – status of today, what has been done	68
9.3	Deliverable 2: Analysis of the Flex-Offer as a commodity	68
9.4	Deliverable 3: Analysis of pricing principles	69
9.5	Deliverable 4: Design of a state-of-the-art electronic marketplace.....	69
9.6	Deliverable 5: Test and demonstration of the marketplace in terms of:	69
9.7	References	69
9.8	Abstracts of papers produced in WP7	70
9.9	Presentations by PhD student Luis Boscan from WP7	71
10	WP8 – Demonstration	72
10.1	Key actors in a simple Market Place.....	72
10.2	Functionality to be demonstrated	73
10.3	Clearing the Market Place.....	75

10.4	Contract and settlement.....	79
10.4.1	House owner	79
10.4.2	Aggregator	80
10.4.3	BRP	80
10.4.4	DSO	80
10.4.5	Market Place	81
10.5	GUI	81
10.6	Demonstration setup	82
11	WP9 – Standardisation	84
11.1	Workpackage objectives.....	84
11.2	Results and disseminations of results.....	85
11.2.1	Standardisation activities	85
11.2.2	Market Model 2.0	86
11.2.3	EvolvDSO	86
11.3	Conclusions and future focus	86
12	Dissemination	88
12.1	PhDs and Postdocs	88
12.2	TotalFlex events.....	88
12.3	Seminars and workshops	88
12.4	Cooperation with other projects	88
12.4.1	Cities	88
12.4.2	Arrowhead.....	89
13	Conclusion	90

1 Introduction

This is the final reporting from ForskEL project 10774: TotalFlex. TotalFlex is demonstrating a Market Place for flexibility.

Project key information:

- Time Schedule: Start 2012 – End 2016
- Partners:



- Project Management:



- Budget: 4.7 M€

TotalFlex is split into:

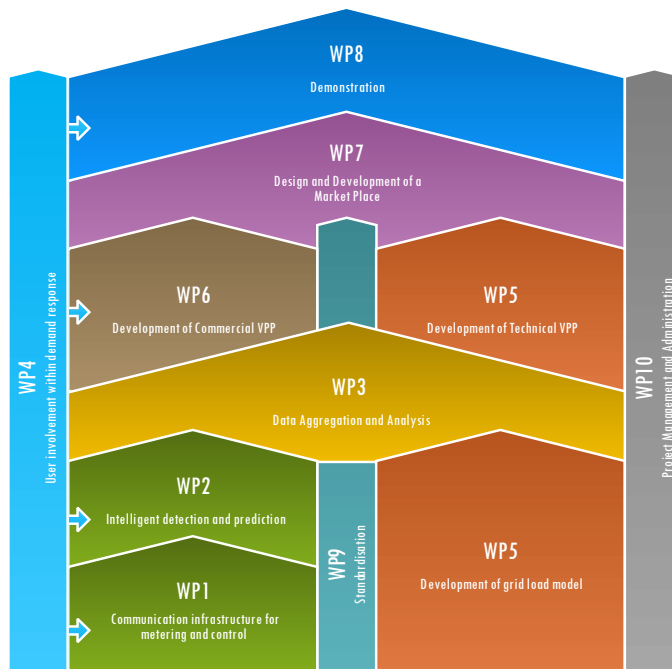

Figure 1: Overview on work packages within TotalFlex

The work packages 1-5 and 7 has the biggest share of research content.

1.1 Objective

The main focus for TotalFlex is to deal with these two global trends:

Increasing share of fluctuating electricity in the grid

<ul style="list-style-type: none"> ● Activation of demand response ● Synchronise consumption with production 	<ul style="list-style-type: none"> ● Export of "cheap" electricity out of Denmark ● Major expense to "stand by" power plants
--	--

Global power consumption increasing due to increased wealth and conversion from fossil-based consumption to green consumption (to i.e. heat pumps and Electrical Vehicles)

<ul style="list-style-type: none"> ● Activation of demand response ● Move consumption away from peak hours 	<ul style="list-style-type: none"> ● Strengthen the grid
--	---

Right side in the above table indicates the traditional solution to the challenges and left side is the solution pursued by TotalFlex.

The status today is:

- Literally no households are delivering flexibility today, only special huge industries
- No general modelling and online monitoring of low voltage radials in the grid
- No business model or link exist today between DSO¹ and BRP²
- A few VPP's³ exist, but mainly aggregating CHPs, not household devices

Actually, there might be conflicting interest between a BRP and DSO which can be shown like below:

¹ DSO: **D**istribution **S**ystem **O**perator has solely grid operation responsibility for a unique geographical area

² BRP: **B**alance **R**esponsible **P**arty has been delegated a balance responsibility from the TSO (**T**ransmission **S**ystem **O**perator, i.e. Energinet in DK) for a share of Prosumers

³ VPP: **V**irtual **P**ower **P**lant

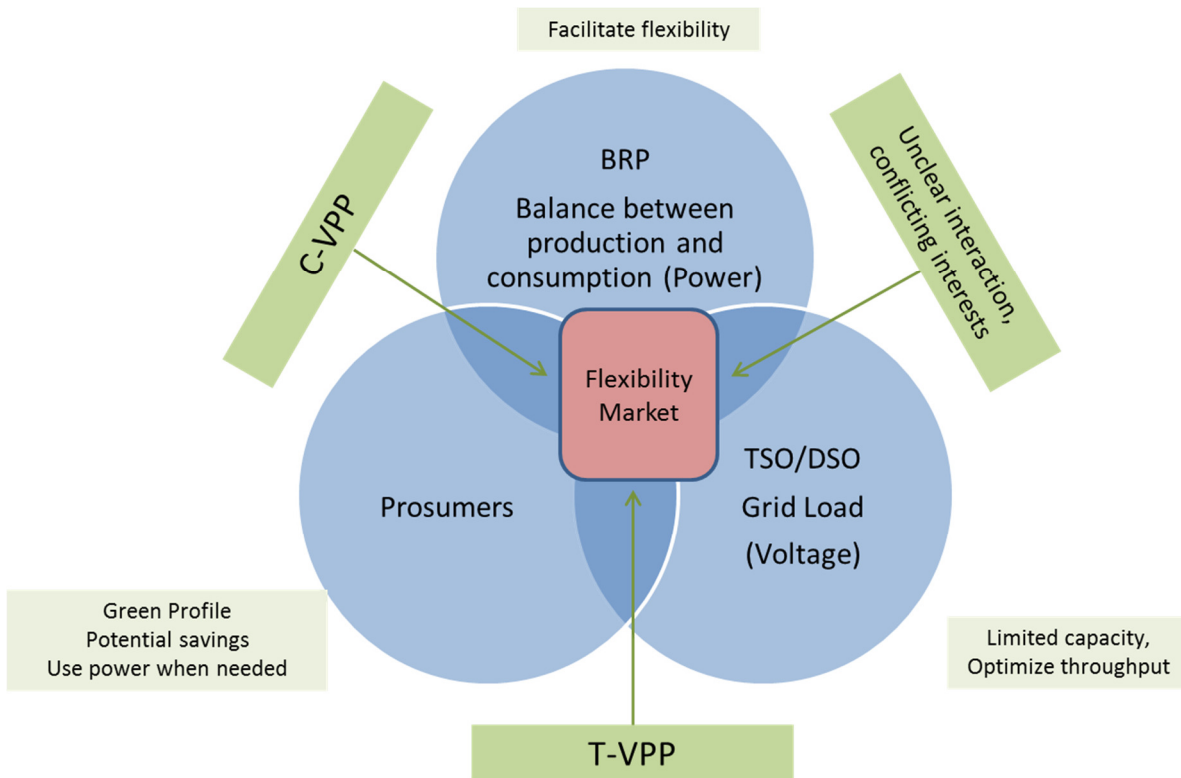

Figure 2: Triangle relationship between Prosumer, BRP and DSO

Let us imagine a prosumer⁴ with a flexible resource⁵, i.e. an Electrical Vehicle (EV). The EV owner will try to charge when prices are low. If many EVs are doing the same on the same low voltage radial, this might create a bottleneck and thus overload the grid. In general, the DSO wants a flat load in order to maximise its capacity and it contradicts the time varying prices.

The objective with TotalFlex is to design a flexible, attractive and cost-effective electricity system for *any* size of flexible consumption and production, where

- Electricity customers are rewarded from the highest bidder for the flexibility provided
- The electricity system is better balanced resulting in
 - Consumption and production are synchronised
 - Lower prices for system services
- DSO can postpone grid reinforcement due to bottlenecks as congestions are mitigated

A concept for describing flexibility of any size and origin is *Flex-Offer*. This is original invented in the EU project Mirabel. Flex-Offer is used in TotalFlex to describe flexibility.

⁴ Prosumer: A producer or consumer of electricity

⁵ Flexible Resource: Device which consumes or produces electricity and has the capability to shifts its operation backward or forward in time

2 General description

This chapter introduces a typical user story. Then issues to be addressed and expected findings are listed.

2.1 User story

A residential house owner has bought an EV and a heat pump. They are of the modern type that are connected to the cloud for external monitoring and operation visibility. The devices are sub-metered and visible to the outside community.

Two aggregators⁶ specialized in heat pumps and EVs respectively are now offering the device owner an analysis of some historical operation data and a clarification of use pattern and comfort requirements. Based on this the aggregators can now offer the device owners a contract about supply of electricity and usage of flexibility. The aggregators have an agreement with a BRP regarding electricity supply and coverage of imbalance cost. The device owner accepts the contract as this is more attractive than a normal electricity contract and because he is then contributing actively to the green transition.

The aggregators are first optimizing the operation of the devices to achieve lowest energy prices day ahead. This is done by modelling device operation and user behaviour and use the model to predict coming day's demand and its flexibility. Based on this the baseline operation flexibility is now aggregated into useful sizes and offered to the new Market Place for Flexibility.

At the same time a DSO have noticed a new type of load on his low voltage grid from the heat pump and the EV. The new devices are increasing the load on the grid especially in the peak hours. With more similar devices, this might be an issue and the DSO decides to try to smoothen the grid load by buying flexibility on the new Market Place for Flexibility. A request is now sent to the Market Place.

Similar the BRP has some imbalance now and maybe foresees more in the coming hours. This might create a later extra cost after settlement. This can be mitigated by activating some flexibility from devices within the BRP's balance area and therefore the BRP also sends a request to the Market Place.

The Market Place is selling and buying flexibility for various markets covering different time horizons, like long-term, day-ahead and intra-day. In the Market Place the aggregated flexibility from the heat pump and EV is now sold to the highest bidder. This also means the flexibility is now scheduled, i.e. the actual operation of the heat pump and EV is fixed.

The scheduled flexibility is now going back to the aggregator where it is disaggregated into actual operation schedules for the heat pump and EV. In parallel to this settlement in the Market Place is done between the involved parties and this also means that settlement between the flexibility owner and the Aggregator can be done in line with the existing contract.

2.2 Expected findings

The expected findings from TotalFlex will be:

- Solution bridging existing Smart House solutions with a gateway to activate flexibility
- Method to intelligent detect flexibility **through** existing meter data

⁶ A separate business entity or functionality which collects data from and controls a number of flexible resources by offering a single interface and handle.

- Method to create Flex-Offers with limited user involvement
- IT tool: TVPP, which monitors and models grid capacity and predicts and control coming load and bottlenecks
- IT tool: CVPP, which combines market opportunities and imbalance mitigation into a Flex-Offer used for the Market Place
- Market place for Flex-Offers, that optimize market potentials, grid capacity and imbalance cost
- Attractive business models for BRP, DSO and the customer

3 WP1 – Communication infrastructure for metering and control

3.1 Executive summary

Three major challenges on energy flexibility management are addressed by WP1:

- The variety of prosumer devices and systems (being part of the Internet of Things) that potentially can contribute to a future flexibility market, calls for a uniform way to make them accessible. As a solution for handling this challenge, a general software platform, Homeport, has been developed and demonstrated.
- When prosumers participate in future flexibility markets, they also allow the market to influence the control of their devices and systems. Although most energy systems are not safety critical, it is still a challenge of making sure that they are correct and follow their specifications so that discomfort is avoided. WP1 has developed and demonstrated a toolchain which supports the analysis and validation of future smart energy systems with special emphasis on home automation.
- Energy systems are becoming integrated parts of the set of systems that support the emerging smart societies, and system interoperability is therefore an extremely important aspect. WP1 has taken up this challenge jointly with WP3 resulting in design and demonstration of an architecture for aggregation/prosumer interaction in the context of the European FP7 project Arrowhead⁷. This context means that the joint WP1/WP3 solution has been demonstrated within an interoperability framework covering also domains like efficient manufacturing, efficient energy production, EV charging and smart buildings.

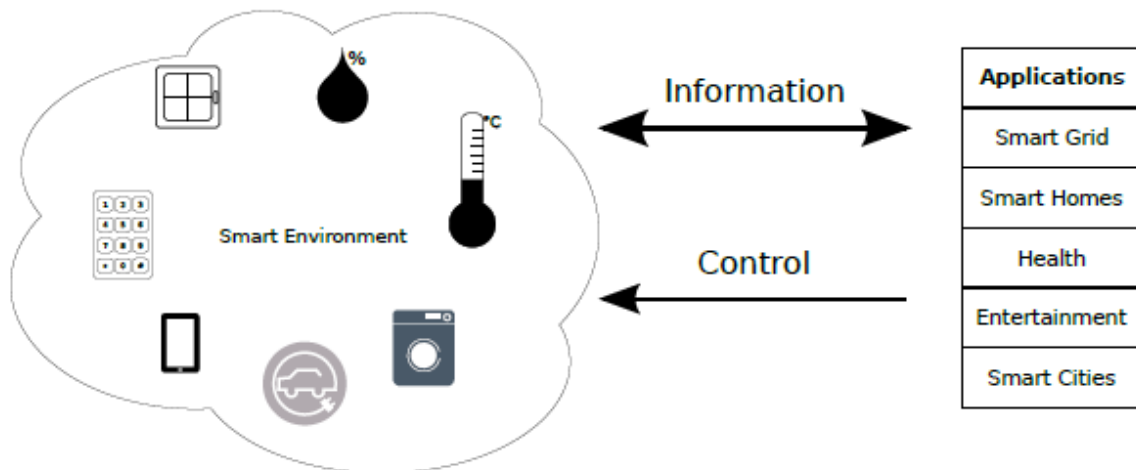

Figure 1: A simple view of the Internet of Things

As a foundation for the work, a state-of-the-art analysis on existing communication infrastructures has been carried out. Based on this, a recommendation for the TotalFlex solution has been

⁷ Arrowhead framework: <http://www.arrowhead.eu/> FP7 multinational project

made – pointing at a further development of previous work on Homeport supporting communication with the project partner's Zense smart metering system.

The resulting Homeport system is based on a contemporary REST interface towards the Internet in combination with a simple and extensible adapter concept for including new prosumer devices.

Several examples on how to apply the tool-chain have been demonstrated:

- A methodology for defining and analysing smart-home user scenarios like dynamic temperature schedules, alarm setting etc. has been developed. In this way, one can assure that scenarios do not contradict each other.
- A methodology for analysing how different control strategies may interact and contradict each in a smart home setting has been developed. In this way, it can be assured that schedules received from an aggregator, are compatible with existing energy systems of a given building.
- A methodology for testing smart home control software before being set in operation. Often errors in control software occur due to unforeseen events in the environment, like e.g. extreme weather conditions, and the methodology allows for automatic inclusion of such extremes in the test suites.

The joint architecture for aggregator/prosumer communication allows for dynamic setup and orchestration of different types of aggregation services and it has been validated jointly with companies like Schneider, Honeywell and FIAT in the context of the Arrowhead project.

The generality of the results implies that they are likely to be part of the succeeding steps on creating a real flexibility market. Concrete steps are already being planned in collaboration with the city of Aalborg.

3.2 Introduction

The aim of WP1 is to provide the basic metering data to be used in calculating Flex-Offers and also to enable execution of the derived demand schedules. That is: (1) To develop an infrastructure which supports detailed, real-time, energy metering for all relevant devices, appliances and subsystems within a given consumer domain (house, neighbourhood, industry, etc.), and (2) To provide the necessary mechanisms to control the actual demand within a domain according to a desired schedule.

In order to realise the above metering and control purpose, a number of basic subtasks must be addressed:

1. First of all, a building communication infrastructure must be defined that supports the inclusion of an appropriate subset of existing domestic standards like e.g. INSTEON, X10, PLC BUS, KNX (standard), System Box, LonWorks, C-Bus, SCS BUS with OpenWebNet, Universal power-line bus (UPB), UPnP, ZigBee and Z-Wave. Initial work on such an infrastructure has been made through a national project (www.energybox.dk) aka. the Homeport Project, and it will further be developed through a newly initiated EU FP7 project (encourage.aau.dk). In TotalFlex, the infrastructure will be adapted towards the domestic standards that provide the best starting point wrt. metering and control of energy consumption for large scale demonstration of Flex-Offers. It is expected that powerline communication will be one of the selections, as the partner zensehome has a large number on existing commercial installations which will form the basis for large scale experiments. As documentation of this work, two deliverables D1.1 (State of the art) [1] and D1.2 (Analysis and Selection of Domestic Communication Technologies) [2] are included as appendices – concluding that a domestic gateway with interfaces to smart meters and powerline communication is sufficient for the needs of TotalFlex in order to generate Flex-Offers.

2. Secondly, the device abstraction should be general, which means that coming devices, which are unknown today, should automatically be adopted. This abstraction must encompass simple and complex subsystems (e.g. HVAC, heating pumps or cars) as well as aggregates (e.g. all appliances in a consumer domain), but focusing on devices where the demand can be shifted in time (build in flexibility). This work constitutes the main scientific results of WP1 and it is documented in a PhD thesis [9] containing 6 papers – included as appendix. The results include:
 - a. The design and implementation of a general purpose domestic gateway, Homeport [3], with a simple web interface for external access and a simple notion of adapter for handling and exposing services using specific kinds of devices like e.g. Zense-powerline, heat pumps, etc.
 - b. The inclusion of Homeport in a general-purpose tool chain, which can be used for simulation, validation and even synthesis of high-level smart-home designs [4,5].
 - c. A methodology for analysing smart-home designs for feature interactions between e.g. scenarios for intruder alarms and automatic opening of windows for ventilation [6].
 - d. A methodology for automatic testing of smart-home software system implementations [7].
3. Finally, the device abstraction of a given domain must be made available for the Flex-Offer market place through a well-defined service interface and via the CVPP (see WP6). Part of this includes an analysis of the basic requirements to consumer privacy and security wrt. domestic data. Although privacy and security are not the main issues of TotalFlex, it is important that the consumers participating in the demonstrator work package can have a basic trust to data handling. Also, the relevant standards within IEC 62351 will be taken into account. This work has been carried out in collaboration with the EU FP7 project Arrowhead, and it is documented in [8] where a general architecture for Flex-Offer generation and aggregation is described. Also, the implementation has been demonstrated at a series of events.

In the following, we describe in more detail the results of subtasks 2 and 3 above.

3.3 Homeport (2a)

Ideally, all service providers and consumers should be able to communicate with each other, using a common format. However, due to the use of different technologies and standards, but also physical and technological constraints, devices are separated into clusters. A cluster is a collection of interconnected devices which has a set of properties. These properties define the way in which devices can interact with each other, and the semantics of the messages they exchange. An example is a set of home automation devices communicating using the ZigBee standard, or a set of messaging client exchanging messages over the Internet. In order to build system of systems using such clusters, the mismatch between their properties needs to be resolved. Property mismatch occurs at different levels. At the data level, mismatch can exist between the syntax and the semantics used to represent information. For example, one cluster could represent temperature in degree Fahrenheit encapsulating it using the JSON format, while another could represent it using degree Celsius and the XML format. At the protocol level, different communication paradigms can be used. One cluster can use a polling mechanism for events, while another can use a push mechanism. Finally, at the application level, mismatch can exist between business-process logic and interface signatures. To interconnect heterogeneous clusters, a component fixing these mismatches is essential. This is the role of gateways, that translate the messages exchanged between two or more clusters.

The HomePort middleware [3] aims at solving heterogeneity issues in distributed systems, and in particular home automation systems. It is essentially a gateway, or web proxy as it provides a

web interface, but also provides service discovery services. Heterogeneity arises in home automation due to the difference in the requirements of the subsystems. For example, the security system of a house needs to be protected from potential attacks. Thus, a good technological choice to implement this system might be to use a wired protocol to reduce eavesdropping possibilities. In contrast, a sensor network might not need high protection, and using a wireless technology to implement it facilitates its deployment in the house. Heterogeneity is thus not only a problem, but also a necessity in order to satisfy different sets of requirements. To solve it, data formats and communications need to be adapted between sub-systems. The solution proposed by the HomePort middleware is to provide a common interface for accessing devices located in separate networks. An example of a HomePort setting is shown in Figure 2.

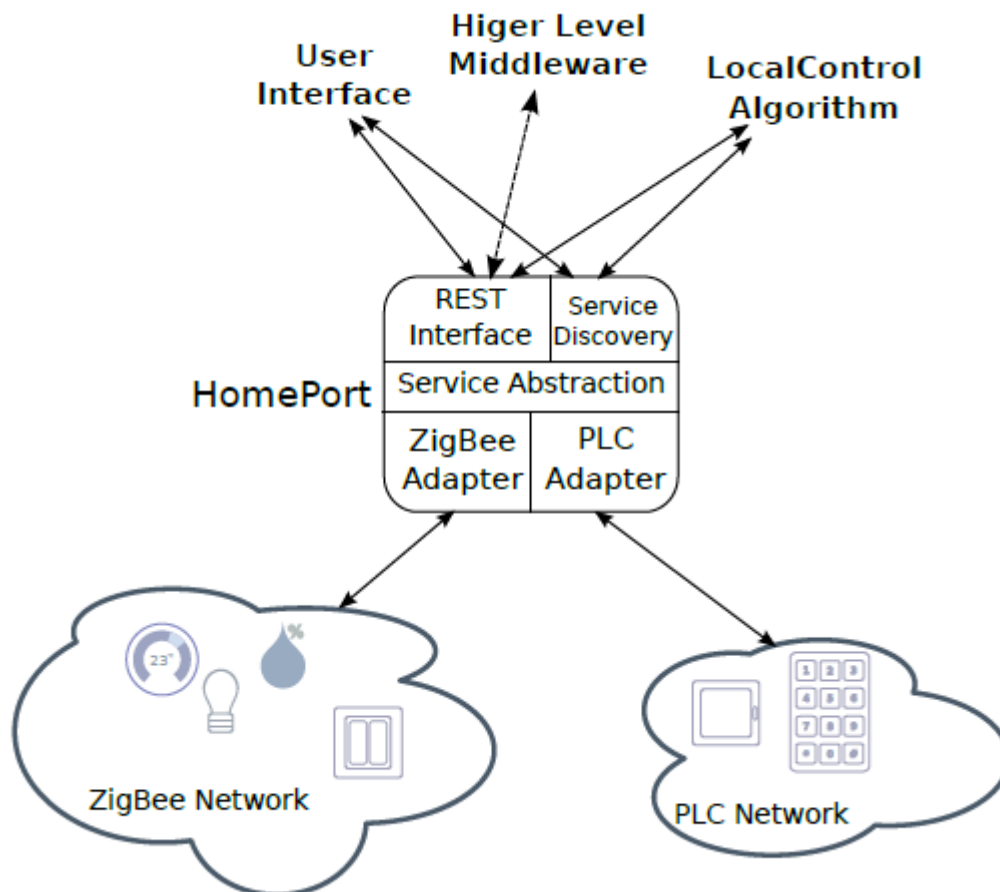

Figure 2: Example of a home automation system using HomePort

Here two different networks contain two sets of devices, one providing access to temperature and humidity sensors, as well as a lamp and a switch, the other to a window and a keypad providing information on the security system. Given this setting, it is interesting to control the window based on the temperature in the room, but still making sure that it does not open while security is activated. To do so, a common access to the different devices is needed. This could for example be through the control algorithm depicted in Figure 2. HomePort acts as a common interface to the two sub-networks, abstracting their services in a common representation. This representation is made accessible through a so-called REST interface implemented using the HTTP protocol. In this interface, each service is mapped to a set of predefined methods. The most commonly implemented ones include the POST, GET, PUT and DELETE methods, that often are used to implement so-called Create Read Update Delete (CRUD) paradigm. However, this does not have to

be the case and the semantics assigned to the methods is to some extent left to be defined by the implementation. For more details on REST, see [3].

The translation from the messages transmitted over the Web to the ones transmitted on the sub-networks is performed by adapters. The translation needs to be done at the data level, protocol level and application level. At the moment, the implementation of adapters is left to the user of the system. However promising research on automated synthesis of such adapters could make this step easier. HomePort also includes a service discovery mechanism using the Zero-configuration networking set of tools, to advertise provided services to potential clients.

In the context of the previously introduced generic architecture, Home-Port implements as one component the gateway and middleware functionality. Authentication is handled by providing SSL certificates, and some suggestions for implementing authorization were made in [3]. Note that no storage services are provided as it is only intended as a linking interface to the devices located in its subnetworks. However, HomePort facilitates building higher level middleware.

3.4 Tool chain (2b)

This work focuses on the application services that interact with actuators, changing their state to influence the behaviour of variables in the home. The specifications of such services often indicate how the system should react to various events. An event represents an observable change in the state of the system (value reported by a sensor or actuator), while an (re-)action consists of a control signal sent to an actuator. Actions can also consist in generating data, or exchanging information. For each Smart Home in a Smart Grid system, there is thus a set of controllers responding to events inside the home. Each controller implements a functionality corresponding to a requirement of the system. For the purpose of analysis, a Smart Home is defined as a plant, a system to be controlled. A plant is composed of a set of observable variables that define its state space, function of time. In a Smart Home, these variables represent indoor temperature, humidity or presence for example. A plant also contains sensors that make the plant variables observable. For each plant variable considered there must be some atomic or composite service capable of reporting its value. A set of actuator services also enable control over plant variables. A heater, increasing the temperature, or a light affecting luminosity are examples of actuators. In addition, a set of disturbances are defined in the plant, that affect its behaviour in an uncontrollable although defined manner. The controllers use the set of sensors to monitor the state of the plant, and control its behaviour through the set of actuators. For the purpose of this analysis, the middleware and other communication components are abstracted away. The abstracted model is shown in Figure 3.

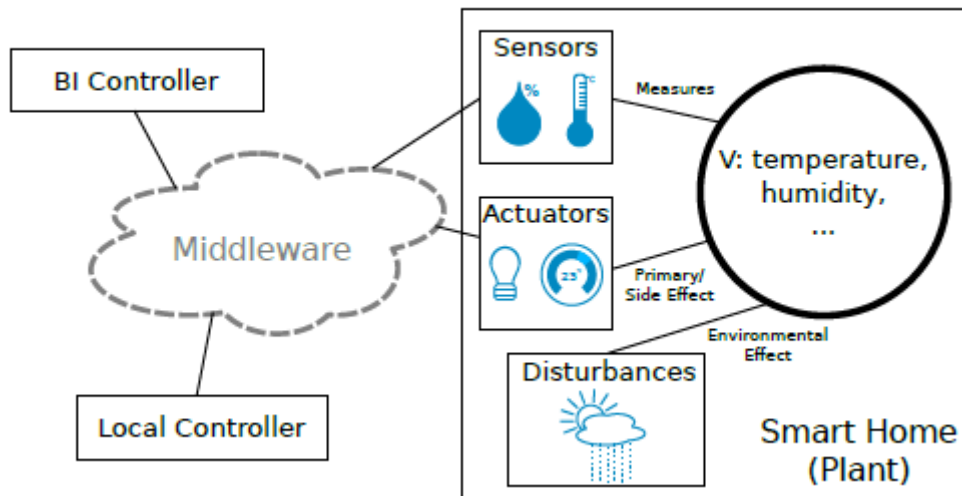

Figure 3: Abstracted model for the controller analysis

The models of the sensors and actuators can be automatically generated using the meta-information provided through their respective services. [4] proposes a transformation from the representation provided through HomePort services to Uppaal timed automata. These models represent the interface between the controller and the sensors and actuators. It is then necessary to specify the effect of actuators and disturbances on variables. In [4], the dynamics of the variables are modelled as functions of actuators' state.

3.5 Feature interactions (2c)

Each controller implements a different set of requirements, corresponding to a functionality, provided by the system. They interact with an overlapping set of plant variables and actuators, which means that interaction between the functionalities can occur. This is known as feature interaction, where the term feature represents a functionality provided by the system. Figure 4 illustrates a feature interaction scenario. This simple system is composed of three features:

the heating feature uses the thermostat to control the indoor temperature;

the alarm feature monitors movement in the room and triggers an alarm if it detects one;

the humidity feature uses the window to control the humidity, which has a side effect on the temperature and movement.

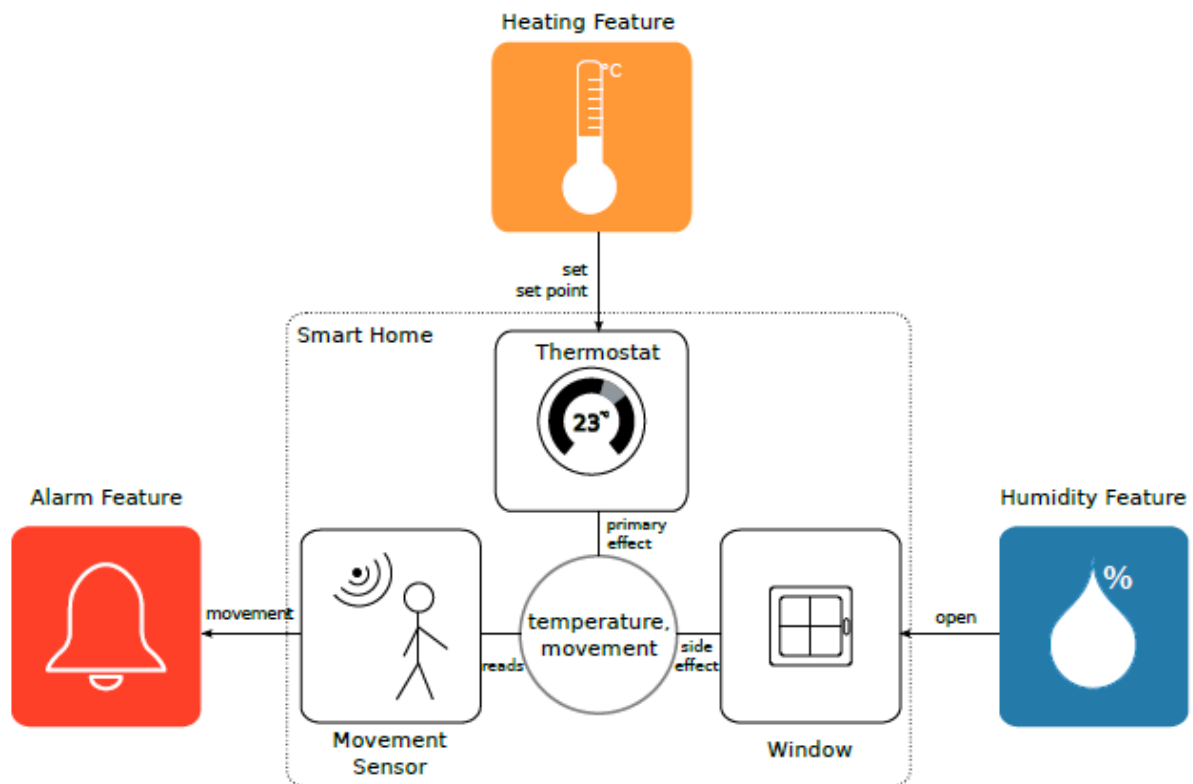

Figure 4: Example of a system with feature interactions

Two possible feature interactions can occur in this scenario. Firstly, the heating and humidity features can interact as they both affect the temperature. Secondly, the window, when opening, creates movement that could trigger the alarm. The presence or not of these interactions, as well as their impact on the satisfaction of the requirements depends on the specifications. Undesirable interactions could for example be avoided by ensuring that the window only opens when the outdoor temperature is acceptable, and when the alarm is not active. However, the main issue is often simply to be able to detect these interactions; if it is relatively easy on a system with three features and two variables, it becomes more complicated as the number of features and variables involved increase. [6] proposes a methodology to identify the plant variables and the effects that actuators have on them as input to a timed automaton model similar to the one previously presented. The main difference is in the use of guardian automata that monitor write accesses to plant variables from actuators and disturbances. This makes it possible to perform sanity checks to ensure that plant variables are not simultaneously affected in contradictory manners. Note that verifying requirements can also reveal feature interactions leading the system to undesired states.

3.6 Testing smart home software (2d)

The analysis work described so far has been focused on validating Smart Home systems during the design phase. The reason is that fixing errors at that stage is usually easier and less expensive. However, errors can also be introduced by incorrect implementation of specifications, defective components or unspotted errors during the design. Testing that a system conforms to its specifications and requirements after its implementation and deployment on embedded systems is thus essential. In addition to finding errors and defects, testing is also a valuable source of statistical information for reliability and safety analysis. There has been extensive research in system and software testing, and various paradigms have emerged. Model based testing in particular relies on a behavioural model of the system to detect unexpected deviations of the ob-

served system behaviour. It is a natural continuation to the model based analysis process proposed in the previous chapters of this thesis. Reusing the models is not only a good reuse of resources, but also add assurance on the consistency of the system specifications. During the implementation phase of a system, two types of tests can be distinguished. The first type is called unit testing, and is used to validate the correctness of the functionalities provided by the individual components or units of the system. The second type is called integration testing, and aims at ensuring that the composition of functionalities provided by individual components correctly implement the specifications. When implementing large system of systems, dividing it into components enables separation of concerns and parallel development of functionalities. For this to be successful, component contracts are used to specify the expected behaviour and functionalities of a component.

Component contracts specify four level of constraints: Syntactic, defines the types expected and produced by the component functions; Behavioural, defines the expected outcomes of the component functionalities; Synchronization, defines the protocol of the component, the order in which its functionality should be called; Quality of Service, defines timing and other non-functional requirements of the functionalities.

Syntactic and behavioural levels are normally checked by unit tests, when the functionalities are being implemented. Synchronization and quality of service levels, however, usually require the components to be assembled to be validated, and are thus checked during integration testing. A potential issue with separate unit and integration testing is that the component integration can invalidate some of the unit tests. For example, introducing a gateway, or a middleware between an application service and the environment it controls can introduce errors in the delivered functionality. This is especially true for large distributed systems where the number of intermediate components used to implement functionality can be large. To ensure the validity of unit tests once a system is deployed, [7] proposes an approach to combine the four levels of constraints inside a single behavioural model. The model is constructed using timed automata, and can be expected to be a modified version of the behavioural model used during system analysis. A prototype tool is also described. It makes use of the models for performing online testing of the system components after deployment, validating their correctness with respect to their models.

3.7 Aggregation service architecture (3)

The Internet of Things (IoT) enlarges the Internet to physical objects, extending its usage to various applications such as Smart Grids. Most of these objects are pervasive and mainly interact with other Internet devices such as database servers, other objects or services. With many connected objects¹, using a variety of heterogeneous technologies and protocols, managing their interconnection is a challenge. Service Oriented Architectures (SOA) have been developed to abstract the specificity of devices and networks and obtain consistent access to functionalities provided by the objects. In addition, a lot of effort has been put into filling the syntactic and semantic gaps that exist between networks and applications. However, a remaining open issue is how to create smooth interconnection between service providers and consumers in the IoT. The European FP7 project Arrowhead aims at providing a solution to this issue, by developing a framework for IoT applications, including a set of essential services, namely service discovery, authentication and authorization.

In fact, if service discovery is sufficient to establish connection between a service consumer and provider, authorization is usually required, in particular for Cyber- Physical Systems (CPS) involving critical components. This is the case in all the pilot domains of the project, which cover the areas or production, electro-mobility, energy production, smart buildings and an energy flexibility market (or flexibility market).

These five pilots provide a good sample of the diversity of applications that will be provided by the IoT. As illustrated by Figure 5, the flexibility market as developed by TotalFlex is the common denominator between the different pilots, and is expected to provide them its services.

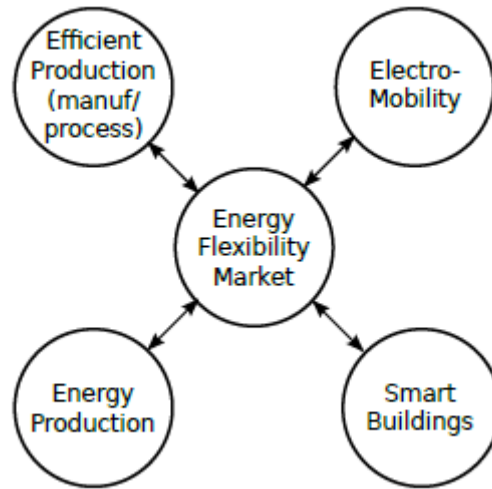

Figure 5: The five pilot domains of the Arrowhead project

[8] proposes a framework for managing energy flexibility based on Flex-Offers, from the end user to a flexibility market where it is traded and assigned an optimal value. The objective is to enable actors of the energy domain to buy flexibility and have more freedom in distributing loads in the grid. The main contribution of [8] is to define the details of this framework, the different actors, their possible interest and their relationships, and to present the underlying ICT infrastructure enabling its deployment. Pilot demonstrations currently taking place in the Arrowhead project are also presented to discuss the applicability of the framework. The framework architecture is shown in Figure 6.

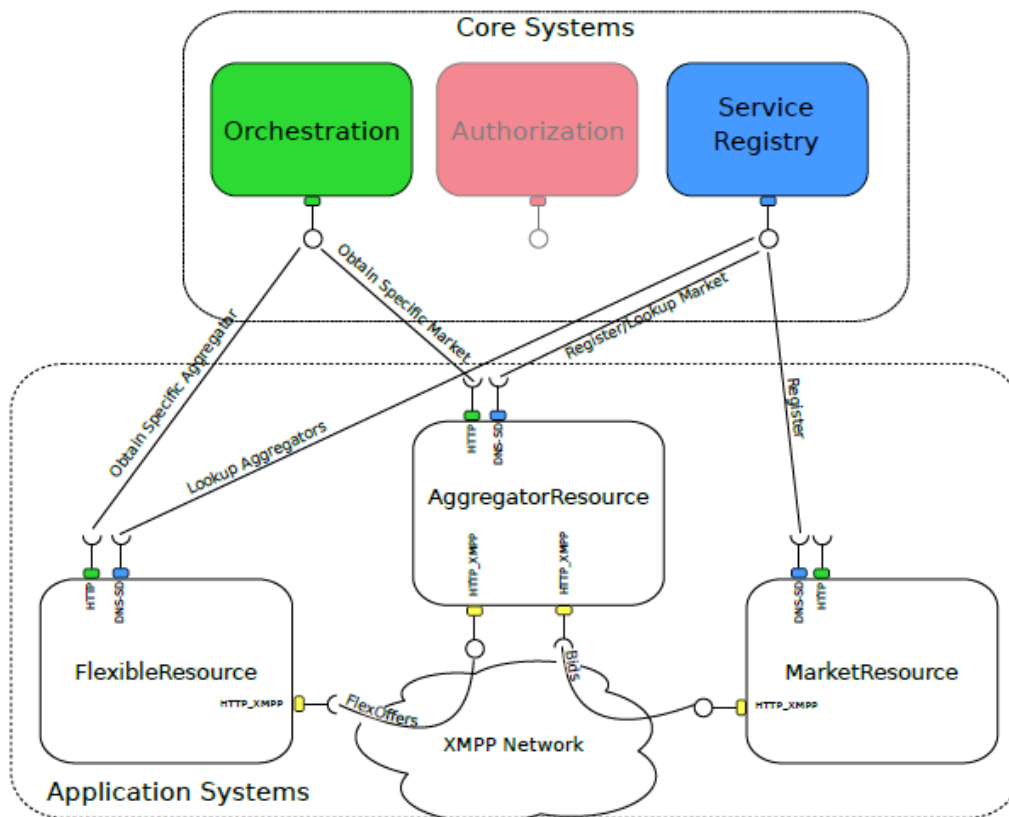

Figure 6: Software architecture of the Virtual Market of Energy

3.8 References

- [1] TotalFlex deliverable 1.1: Communication infra-structure for metering and control – State of the art
- [2] TotalFlex deliverable 1.2: Analysis and Selection of Domestic Communication Technologies
- [3] Thibaut Le Guilly, Petur Olsen, Anders P. Ravn, Jesper Rosenkilde, Arne Skou. HomePort: Middleware for Heterogeneous Home Automation Networks. Proceedings of the 2013 IEEE International Conference on Pervasive Computing and Communications Workshops (PERCOM Workshops), pp. 627–633, 2013
- [4] Peter H. Dalsgaard, Thibaut Le Guilly, Daniel Middelhed, Petur Olsen, Thomas Pedersen, Anders P. Ravn, Arne Skou. A Toolchain for Home Automation Controller Development. Proceedings of the 2013 39th EUROMICRO Conference on Software Engineering and Advanced Applications (SEAA), pp. 122–129, 2013
- [5] Thibaut Le Guilly, Jacob H. Smedegård, Thomas Pedersen, Arne Skou. To Do and Not To Do: Constrained Scenarios for Safe Smart House. Proceedings of the 2015 IEEE International Conference on Intelligent Environments, 2015
- [6] Thomas Pedersen, Thibaut Le Guilly, Anders P. Ravn, Arne Skou. A Method for Model Checking Feature Interactions. Proceedings of the 10th International Conference on Software Engineering and Applications, 2015
- [7] Thibaut Le Guilly, Shaoying Liu, Petur Olsen, Anders P. Ravn, Arne Skou. Validating Timed Component Contracts. Proceedings of the 2015 41th EUROMICRO Conference on Software Engineering and Advanced Applications (SEAA), 2015

[8] Thibaut Le Guilly, Laurynas Šikšnys, Michele Albano, Per D. Pedersen, Petr Stluka, Luis L. Ferreira, Arne Skou, Torben Bach Pedersen and Petur Olsen. An Energy Flexibility Framework on the Internet of Things. The Success of European Projects using New Information and Communication Technologies. SCITEPRESS Digital Library, 2016. s. 17-37

[9] Thibaut Le Guilly. Ph.D. Thesis, Aalborg University, 2016

4 WP2 – Intelligent detection and prediction

4.1 Introduction

The Work Package (WP) 2 is the section of the TotalFlex project that is responsible for the generation of Flex-Offers for the flexible part of energy demands. The section focuses on an analysis of behavioural patterns of individual devices based on their historical usage data, and use these to predict what flexibility is available in the near future. TotalFlex envisions the extraction of flexibility at a granular level, i.e., device-level. Thus, this WP acquires consumption profile for individual household devices such as wet devices (dishwasher, washer-dryer), electric vehicles, and heat pumps from various sources including WPs 1 and 4. The raw consumption dataset is pre-processed and analysed to extract useful information such as device usage behaviour, operation patterns, correlation between various devices, etc. This extracted information is used to predict flexibilities in future energy demands and generate the corresponding micro, i.e., device-level Flex-Offers. The generated micro Flex-Offers are forwarded to the aggregator (WP 3), which aggregates these Flex-Offers into a larger fewer macro Flex-Offers for trading and scheduling. The flexibilities and associated Flex-Offers are automatically predicted and generated utilizing the historical usage behaviours; this yields a system where user interaction can be at a higher level. The data source, core components, and output of the WP are illustrated in Figure 1.

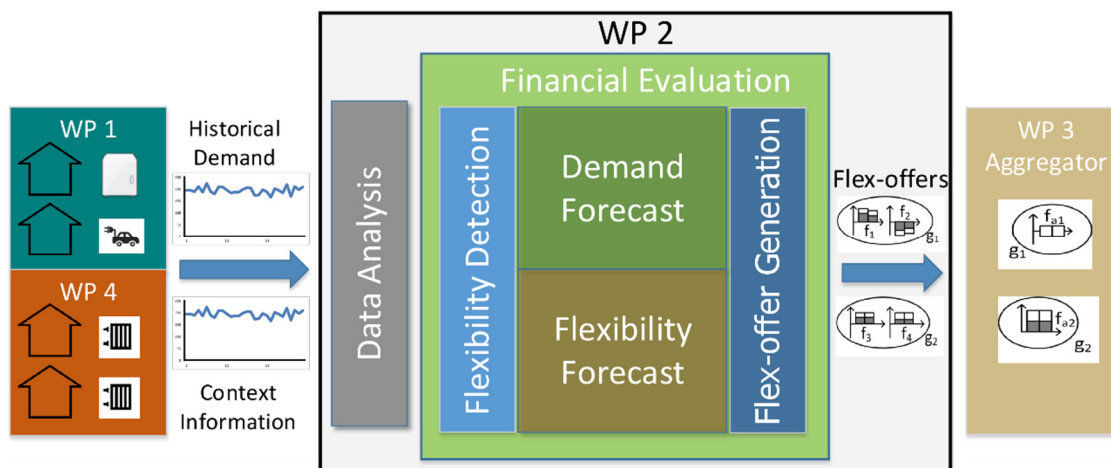

Figure 1: WP2 Components

With the overall aim of generating Flex-Offers for the flexible part of the energy demands, this WP generates deliverables and papers as shown in Figure 2. First, it generates a state-of-the-art analysis on the flexibility and operation patterns of the devices in a set of real households. The outcome of the analysis is used to illustrate the existence of detectable time and energy flexibility in device operations and to generate various attributes (feature extraction) that effectively capture the device operation patterns. Thereafter, it presents and discuss the outcome of various device-level forecast models designed to provide insight on future flexible, non-flexible and total energy demands for the devices. Finally, it presents Flex-Offer Generation and Evaluation Process (FOGEP) that utilizes the output of previous models to automatically generate (potential) Flex-Offers for the flexible part of the energy demand. It presents the experiments and results of the analysis on the financial gain in the spot and regulation market, that can be obtained by utilizing the flexibility (Flex-Off) in devices. Finally, it introduces the platform for device level forecast and Flex-Off generation.

4.2 Dataset

The Flex-Offer generation requires energy demand time series and relevant context information as an input (see Fig. **Fejl! Henvisningskilde ikke fundet.**). Thus, energy consumption time series for individual devices, specifically for wet devices (dishwasher, washer-dryer), electric vehicles, and heat pumps has to be obtained. The data set should be collected at a plug level, where the average energy demand for a device is recorded for each interval, ranging from second up to an hour depending on required granularity. In addition, if available relevant context information such as house area, family size, age, etc. should also be collected to improve forecast models. The details of all the dataset used in the experiments are detailed below:

WP2	Deliverables	Outcome	Dissemination
1	State of the art		Internal report
2	Automatic detection of energy consumption and production at the device level	Section 3	Paper Ref. 4
3	Automatic detection of flexibility in the energy demand and production at the device level	Sections 3 and 5	Paper Ref. 4 and 1 under review
4	Automatic prediction of energy consumption and production at the device level	Sections 4 and 7	Paper Ref. 6 and 1 under review
5	Automatic creation of (potential) flex-offers	Sections 5 and 7	Paper under review
6*	Econometric evaluation of flexibility	Section 6	Paper Ref. 5

* Additional Deliverable

Figure 2: WP2 Deliverables

1) ZenseHome: This is the closed device level dataset containing the average power readings in watts for individual devices. The dataset is logged at a frequency of once every 15 minutes and is collected through January 2014 to October 2015.

1) INTREPID [2]: This is an open dataset that contains energy consumption profiles for household devices recorded at various frequencies. In our experiments, we only use the energy profiles for wet-devices from 30 different households, each containing at least one of the devices washer, dryer, or dishwasher. The dataset includes households in Denmark and Italy.

3) Heat Pumps: This is the closed dataset of power demand for HPs from 50 households in Denmark collected at a 5-min resolution. The HP dataset includes the ambient and room temperatures, and are annotated with various context values such as family size ranging from 1-5 adults per house, house area ranging from 80-700 m^2 , etc.

4) Market Data: To perform a financial evaluation of various model and Flex-Offers, i.e., the saving from the flexibility in device operation, an energy market dataset from Danish TSO Energinet.dk is used.

5) REDD [3]: This is an openly available dataset consisting of energy consumption profiles of six different houses, each containing profiles for 16 to 24 individual devices, and is collected in April to June, 2011. The REDD dataset is collected at the main level, circuit level, and plug level, and the dataset was recorded at various frequencies: 15kHz for main phase, 0.5Hz for circuit level, and 1Hz for plug-level.

4.2.1 Data pre-processing

The device level datasets are usually not annotated and are noisy. Thus, the raw device level dataset has to be pre-processed to transfer it to a form required for flexibility analysis and Flex-Offer generation. The complete sequence of the steps to be taken during the pre-processing of raw input data before allowing the statistical analysis is presented in Figure 3, further detail discussion can be found in [4].

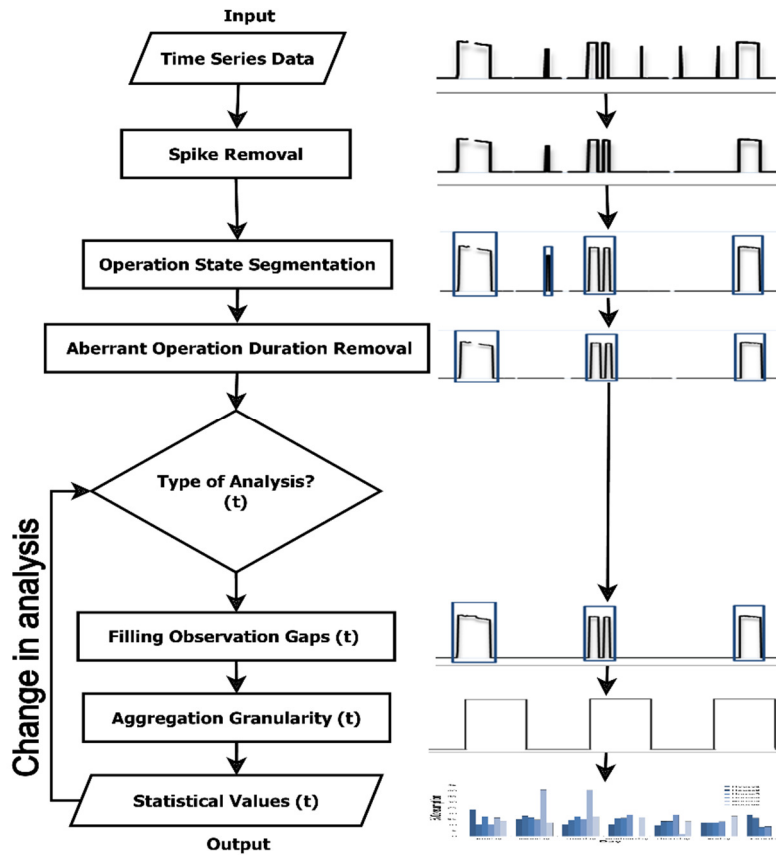

Figure 3: Pre-processing steps

4.3 Flexibility Analysis

Before proceeding with the flexibility analysis, let us first present what we envision about flexibility in device operation and its types. In the near future, most of the household devices would be smart enough to establish a two-way communication with an external unit such as smart meter, etc. These types of (IoT enabled) devices are the smart devices which can be externally controlled to extract flexibility in their operations. Figure 4 depicts the general sequence of actions performed during an operation of a smart device. An operation of a smart device starts with a user performing the *Switch-on* action that signals an Energy Controller (EC) to utilize the device to perform a certain task(-s). An EC is a device-aware external unit that decides on the execution time and the amount of energy to be consumed for a task. The EC can trigger the activate action anytime between Earliest Start Time (EST) and Latest Start time (LST) representing the time flexibility. After the activation of the device, the EC sends the *Consume* action for each time unit until the completion of all task(-s). The consume action signals the device to perform a task consuming $e_t \in \mathbb{R}$ amount of energy at the time t , where e_t lies within a range $[e_{(min,t)}, e_{(max,t)}]$ defined by a minimum $e_{(min,t)}$ and a maximum $e_{(max,t)}$ energy bounds. Finally, at the end of the operation, the EC sends the *Deactivate* signal to the device. The work on the flexibility analysis fits the general usage pattern of devices to the concept of a smart device operation.

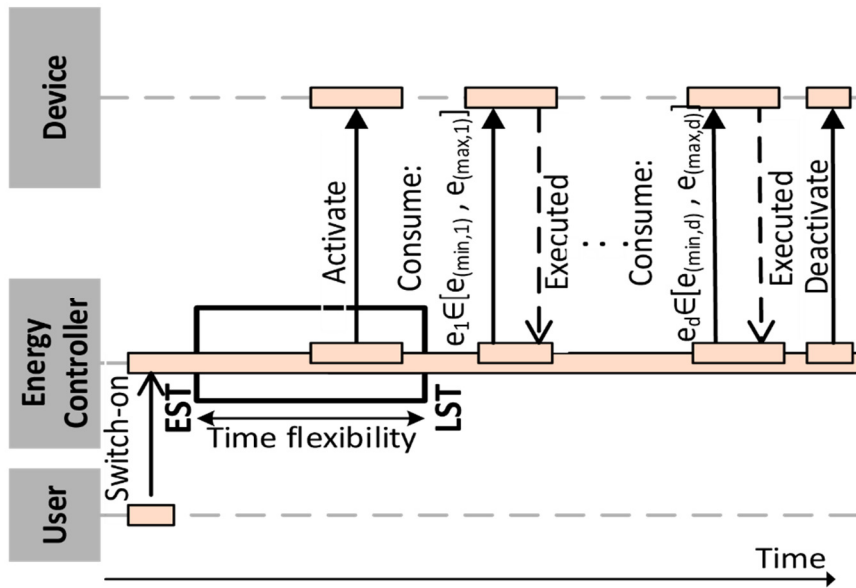

Figure 4: Sequence diagram for smart devices

The experiments on flexibility analysis of devices have shown that on average $\approx 50\%$ of the total energy demand for a house can be considered to provide flexibility, as shown in Figure 6. Further, there exist various repeating inter-day and intra-day, house-specific or general patterns of energy distribution and device operation across individual houses. The existence of peak operating periods for some of the devices shows the potential of extracting time flexibility and a high variation in total energy consumption during device operation (see Figure 5) shows the potential of extracting energy flexibility. There exist some interesting correlations and sequences between device operations, which further provide valuable information regarding activation times of the correlated devices. Though there exists a stochastic behaviour in device usage patterns, the patterns and periodicities can be detected and predicted, and the prediction models can be further improved by incorporating a priori knowledge about the devices and users. The inclusion of a priori knowledge about the devices and users will further reduce the uncertainty in the device-level usage behaviour.

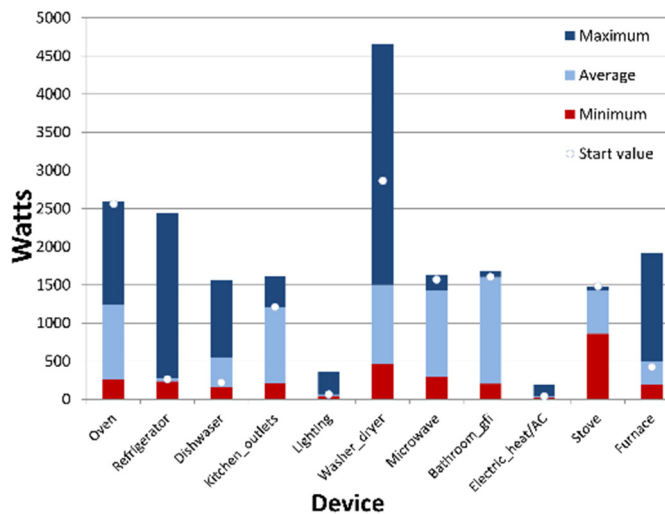

Figure 5: Min, Avg, and Max power consumption (watts) and power consumption during the device activation (shown by dot) for selected devices

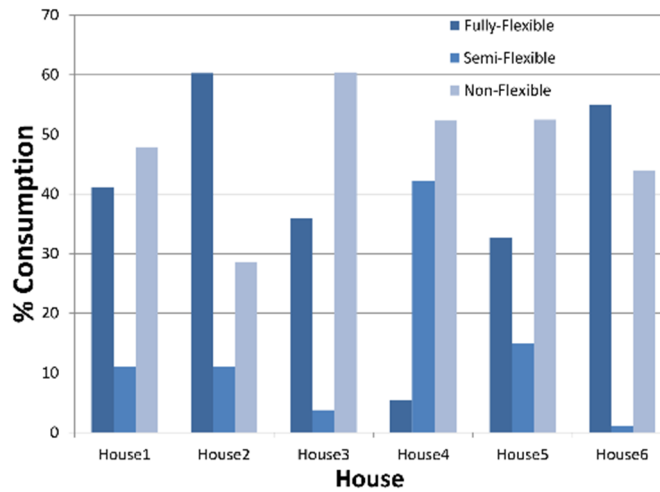

Figure 6: Percentage distribution of total energy consumption by flexibility type from individual houses

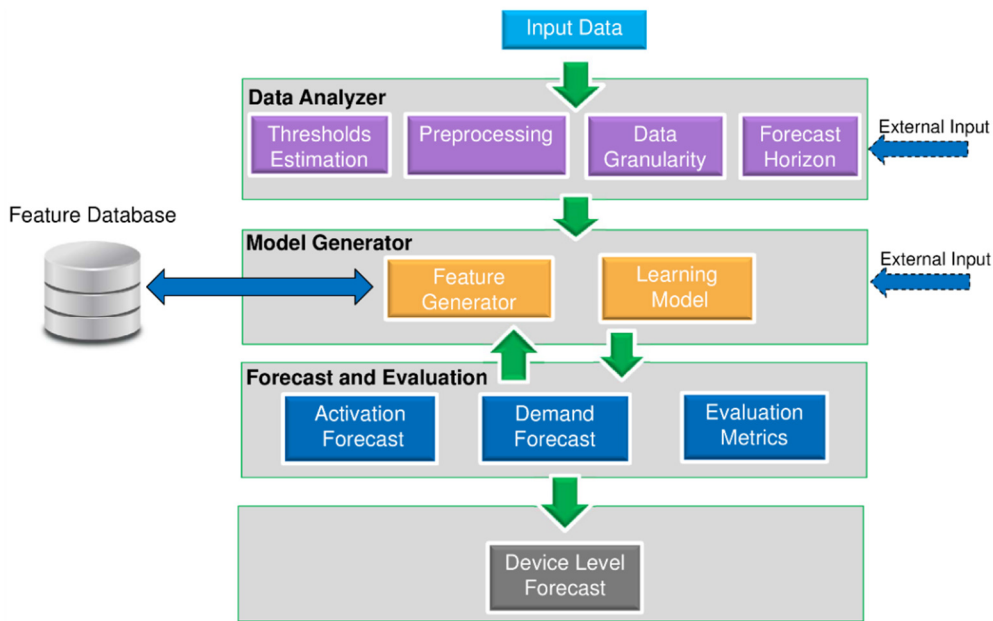

Figure 7: Architecture for Device Level Demand Forecast

4.4 Device Level Demand Forecast

Flex-Offers are to be generated well before the actual demand occurs. Thus, the prediction of future device-level energy demand is an essential component in a Flex-Offers generation model. Figure 7 illustrates the various steps involved in the prediction of device-level energy demand. The experimental results have shown that there exists a trade-off between forecast accuracy and flexibility available. At higher data granularity (hourly prediction) the performance of a forecast model is lower, but captures most of the flexibility in the device usage. However, at the lower data granularity (group of hours or daily), the performance of forecast model improves at the cost of flexibility loss. The performance of a forecast model can be improved by incorporating a priori and context information in the model.

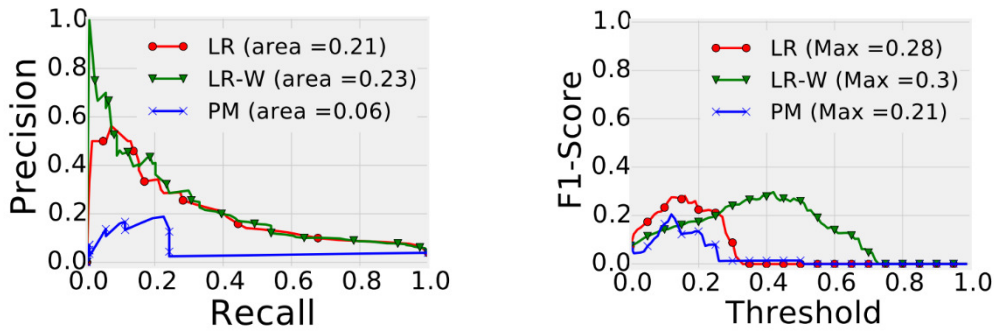

Figure 8: Performance of classifiers (hourly)

Though the forecast model exhibits lower accuracy at the device level, the experimental results showed that the financial gain for a market is much better than implied by the traditional error metrics. Figure 8 demonstrates the performance of three different hourly forecast models, namely Logistic Regression, Pattern Matching, and Logistic Regression with weighted class, evaluated on two different metrics.

4.5 Flex-Offer generation

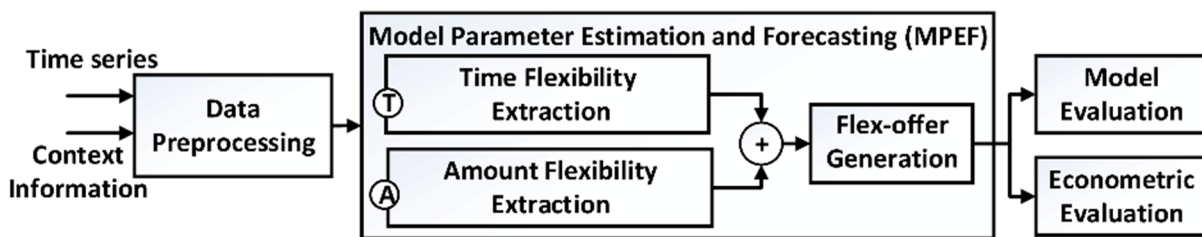

Figure 9: The General FO Generation and Evaluation Process

Figure 9 shows the general steps involved in the generation and evaluation of FOs. The FO generation process starts with the gathering of the energy demand time series and available context information such as the description of house occupants, house insulation parameters, etc. The next step includes the pre-processing of the raw information into a format required for analysing and predicting timestamps and values for the actions captured by FOs. The core *Model Parameter Estimation and Forecasting (MPEF)* includes *Time Flexibility Extraction* which involves the prediction of timestamps of various actions such as Switch-on, Activate, consume action, etc. The second task is the *Amount Flexibility Extraction* which include the prediction of available amount flexibility. The final step combines the outputs of the two sub-steps to generate FOs for the forecasted device operations. The last two steps evaluate the accuracy of the FO generation process and the econometric benefit of the generated FOs in spot and regulation market. The device type specific MPEF sub-steps are shown below.

Wet-devices:

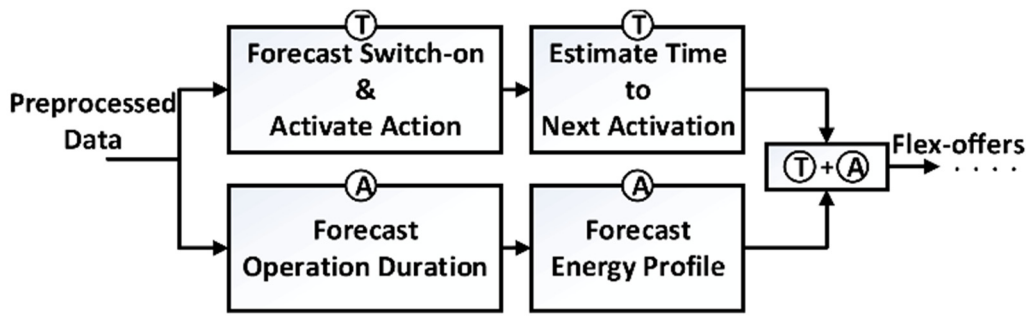

Figure 10: FO Generation sub-steps in the wet-device case

Electric Vehicles:

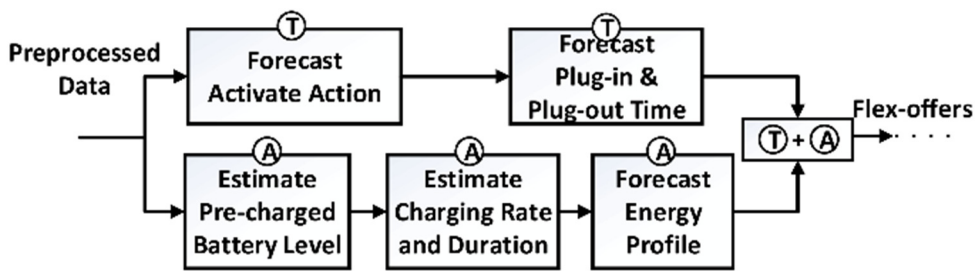

Figure 11: FO Generation sub-steps in the EV case

Heat Pumps:

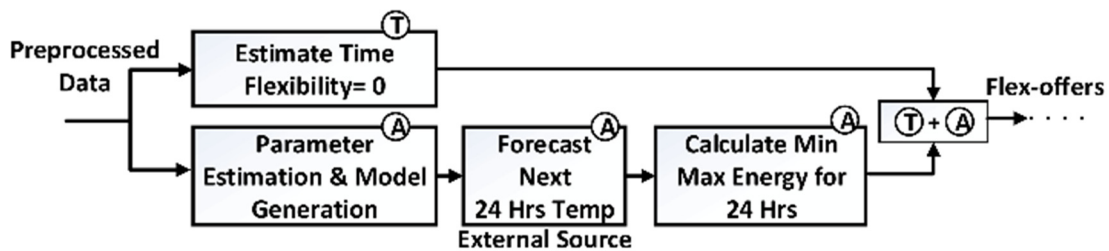

Figure 12: FO Generation sub-steps in the HP case

The experimental results show that there exist significant flexibilities in device usage behaviour and the proposed FOGEP can extract these flexibilities at a higher accuracy, resulting in a financial benefit to all the market players (including BRPs and Customers). Experiments show that on average, wet-devices and EVs provide 15.31 and 10 hours of time flexibility, respectively. Similarly, HPs and EVs provide 33kWh (daily average for winter) and 7.9 kWh of amount flexibility, respectively. Further, the results demonstrate that the preferred market for flexibility depends on its source and size. The device types with only one-dimensional flexibility (either time or amount) generates higher benefits in the spot market, whereas types with two-dimensional flexibilities (both time and amount) can generate significant savings in both spot and regulating markets. Specifically, the flexibility performs better in the regulating market when it has a right blend of time and amount flexibility (EVs). The time flexibility shows a potential of generating higher savings, which is a valuable input to aggregators on deciding which dimension should be retained during aggregation of Flex-Offers. Further, the flexibilities provide up to 51% and 13% savings in the spot and the regulating markets for BRP and/or consumer, respectively.

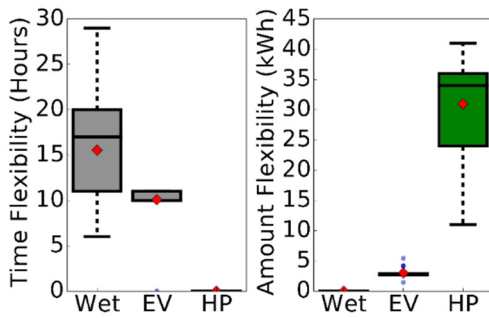

Figure 13: Time and amount flexibility vs device type

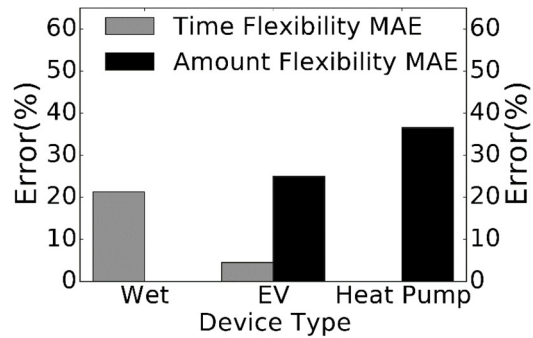

Figure 14: Time and amount flexibility error vs device types

4.6 Market Evaluation

The users should be aware of their incentive for behavioural change, and it should be large enough to drive them towards offering flexibility. Further, the market players are interested in introducing flexibility market, only if it can generate a substantial benefit. The benefits to market can be in terms of reduction in regulation cost, regulation volumes, spot prices, or efficient utilization of their resources that maximizes their revenue or minimizes losses. Here, we mainly focus on quantification of the financial benefits on the spot and the regulation markets.

4.6.1 Effect of Flexible demand on Regulation Market

Displacement of market balance: The shifting of flexible energy from one timestamp to another will displace the anticipated market balance for both timestamps. This displacement will change the regulation volumes in the market and might also reverse the market balance state (e.g., from *demand > supply* to *supply > demand*).

Changes in regulating power prices: The effect of the level of the spot price and the volumes of regulation bid on regulating power prices has been analysed in [7] [2], respectively. The regulating power prices are generally affected by the market balance, i.e., supply and demand. A displacement in the market balance, due to the utilization of flexible energy, will consequently affect the regulating power prices in the market. Figure 15, illustrates the dependency of regulating power prices on the regulation volumes in the market. The dependency between the regulation volumes and market prices can be represented by the hypothetical relation given below.

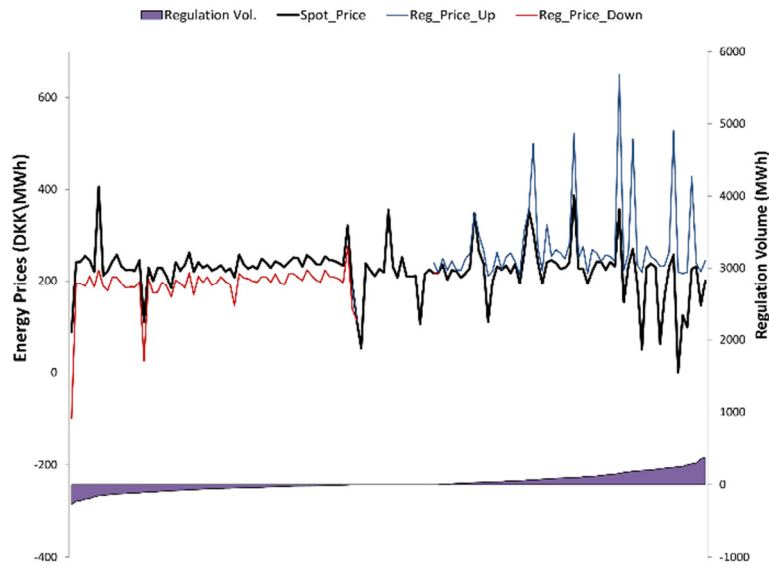
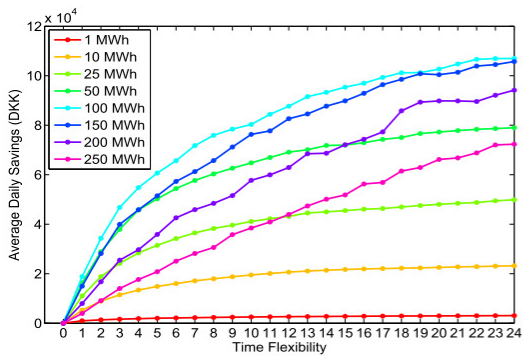

Figure 15: Dependency of energy prices on the regulation volumes

$$p_{u/d}(t) = 1 \cdot p_s(t) + 1_{v_d(t) < 0}(-0.3362 \cdot p_s(t) + 0.0005 \cdot (p_s(t) \cdot v_d(t)) + 1_{v_u(t) > 0}(0.2378 \cdot p_s(t) + 0.0034 \cdot (p_s(t) \cdot v_u(t)))$$

Here, $1_{a < b}$ denotes the indicator function for the predicate $a < b$, and $p_{u/d}(t)$ is the predicted up-regulating power price $p_u(t)$ in case of up-regulation and the predicted down-regulating power price $p_d(t)$ in case of downregulation. Similarly, $v_{u/d}(t)$ is the up-regulating volume $v_u(t)$ in case of up-regulation and the down-regulating volume price $v_d(t)$ in case of down-regulation, and $p_s(t)$ is the spot price at t .

4.6.2 Financial Evaluation



(a)

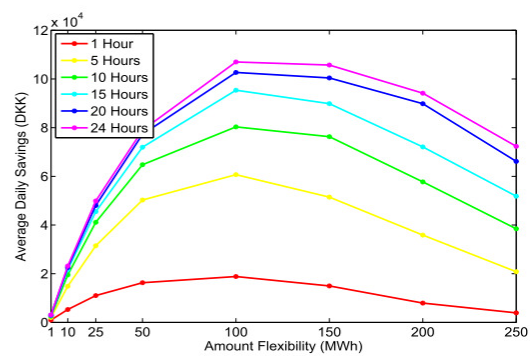

(b)

Figure 16: Savings in regulation cost - averaged across days

The experimental results of demand flexibility show that in general a market can increase its savings in regulation cost with increasing time flexibility, see Figure 16. However, the savings are diminishing for higher time flexibility. For example, for 100 MWh of amount flexibility, 8 hours of forward time flexibility give 71% of the benefit of 24 hours. On the other hand, the size of the amount flexibility plays a major role in determining the benefits of flexibility in the market. The financial benefits of the market grow with the increasing amount flexibility up to a certain limit,

after which it decreases and can be negative, e.g., the highest benefit with 100 MWh of amount flexibility is almost 48% higher than that for 250 MWh. These results indicate that there exists a threshold for the maximum size of amount flexibility that can be traded with profitability. In addition, it also provides the guidelines for aggregating micro Flex-Offers to macro Flex-Offers. The market studied in our experiments can achieve up to 49% reduction in the average regulation cost, with 24 hours of time flexibility and just 3.87% of average gross demand (2.58 GW) being flexible. These results show that the time shifting of flexible demand can generate a substantial benefit regardless of the types of energy flexibility or market objectives. However, the geographical location, the size of the market, and the daytime of RES will determine the optimal size of time and amount flexibility that maximizes the benefits, e.g., demand management for solar energy need a flexible load to be shifted to daytime, which requires higher time flexibility to maximize benefit. Finally, we can conclude that the flexibility has a positive financial impact on the regulation market and the market can trade-off between the available time and amount flexibility, to maximize their benefit and better map the demand with the surplus production from RES.

4.7 Online Platform

The selection of an effective device-level load forecast model is a challenging task, mainly due to the diversity of the models and the lack of proper tools and datasets that can be used to validate them. Thus, we introduce the online system for fine-tuning, analysing, and validating the device-level forecast models. The system is designed as a tool to automate experiments on device-level forecasting and to facilitate the comparison and re-(evaluation) of the existing experiments. The system is also envisioned to provide an open repository of device-level datasets that will be accessible to the research community for further experiments. Therefore, in addition to the graphical display in the interface, the experimental results and datasets are stored in the system database. The system with the most essential components (rectangles) and their dependencies is shown in Figure 17. The system can be accessed at <http://54.186.113.212>.

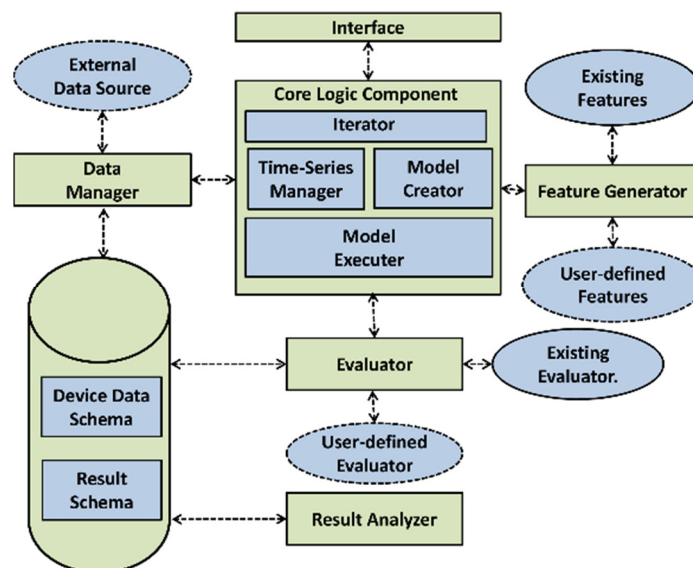

Figure 17: System Components

4.8 Conclusion and Future Work

In the current state, the work from the WP 2 can automatically extract device-level dataset from various sources and generates Flex-Offers for future energy demand of individual devices, specifically for Wet-devices, EVs, and HPs. To achieve this, it has designed an automatic process for

extraction and pre-processing of device-level data and analyse various dimensions to extract patterns in usage behaviour. It has wide variety of forecast models to predict energy demand and associated flexibility for the next day at an hourly resolution, i.e., next hour or 24 hours ahead. It compares the forecast models with a metric suited for the device-level analysis and automatically select a model that best fits the dataset. It has implemented a Flex-Offer generation process that utilizes the outputs from pattern analysis and prediction models. Thereafter, automatically generates Flex-Offers for the predicted flexible demands by performing device type specific Flex-Offer generation sub-steps. Finally, the benefits of the generated Flex-Offers can be quantified in terms of financial gain to users and market players.

However, there still exist many challenges to be solved and some of them are: 1) analysing behavioural patterns for a group of devices together and at various hierarchy, 2) incorporating of a priori information in the forecast model to boost its performance, 3) current work only supports analysis at hourly resolution and need to be extended to 15 minute resolution, 4) dispatching of final schedules of flexible demands to specific devices, and 5) supporting all flexible household devices and generating Flex-Offers for energy supply.

4.9 References

- [1] Source of dataset: Intrepid, intelligent systems for energy prosumer buildings at district level, funded by the European commission under fp7, grant agreement n. 317983.
- [2] I. Ilieva and T. F. Bolkesjø. An econometric analysis of the regulation power market at the Nordic power exchange. *Energy Procedia*, pages 58 – 64, 2014.
- [3] J. Z. Kolter and M. J. Johnson. REDD: A Public Data Set for Energy Disaggregation Research. In *SustKDD workshop*, 2011.
- [4] B. Neupane, T. Pedersen, and B. Thiesson. Towards flexibility detection in device-level energy consumption. In *Proceedings of the Second ECML/PKDD Workshop, DARE'14*, pages 1–16. 2014.
- [5] B. Neupane, T. B. Pedersen, and B. Thiesson. Evaluating the value of flexibility in energy regulation markets. In *Proceedings of the 2015 ACM Sixth International Conference on Future Energy Systems, e-Energy '15*, pages 131–140, 2015.
- [6] B. Neupane, L. Siksnyš, and T. B. Pedersen. Demand: A tool for evaluating and comparing device-level demand and supply forecast models. In *Proceedings of the Workshops of the EDBT/ICDT 2016 Joint Conference, EDBT/ICDT Workshops 2016, Bordeaux, France, March 15, 2016.*, 2016.
- [7] K. Skytte. The regulating power market on the Nordic power exchange Nord Pool: an econometric analysis. *Energy Economics*, pages 295–308, 1999.

5 WP3 – Data aggregation and analysis

This work package had two major objectives. The first objective was to develop a number of techniques for aggregating and disaggregating various kinds of Flex-Offers – those with or without prices, baseline schedules, capacity limits, and complex total energy constraints. The second objective was to develop an integrated data aggregation and analysis system (ADS) by utilizing some of the aforementioned (dis-)aggregation techniques. The primary users of the ADS are C-VPP operators and/or Aggregators (WP6). For these users, ADS serve as a comprehensive data management and business intelligence solution, which allows efficiently collecting, (dis-) aggregating, and analysing relevant Flex-Offer data (including consumption and production profiles, prices, etc.). Next, the relevant concepts and major findings of this work package are presented.

5.1 Flex-Offer Aggregation and Disaggregation

As presented earlier, the flexibility of an individual Prosumer appliance (WP2 and WP5) is captured and represented as a Flex-Offer. This representation makes it practical to exchange the flexibility information between different entities. However, Flex-Offers from individual Prosumers (e.g., heat pumps, electric vehicles) most often do not represent large flexible loads. Thus, a single such Flex-Offer has low impact and is of little interest for electricity trading, peak shaving, and balancing demand and supply on the grid, where required balancing capacities are much higher. At the same time, optimising energy loads based on large numbers of Flex-Offers is a computationally hard problem, which requires dealing with many decision variables and constraints originating from many Flex-Offers. By utilizing *aggregation*, flexibilities from individual appliances can be combined and thus offered in the more useful and efficient aggregated form. Such aggregated flexibility can again be represented as Flex-Offers – but with much larger energy amounts and flexibility margins. Aggregation is typically performed by C-VPP operators and/or logical entities called Aggregators (WP6). They receive Flex-Offers from individual Prosumers and then aggregate these Flex-Offers. The flexibility of aggregated Flex-Offers tends to be lower than the joint flexibility of the Flex-Offers that compose them. This reduction in flexibility is, however, unavoidable in order to reduce Flex-Offer scheduling complexity and to increase their value (e.g., on the flexibility market). After aggregation, *schedules* are typically assigned to the aggregated Flex-Offers (e.g., based on energy sold on the market – WP7). By respecting all inherent aggregated Flex-Offer constraints, a schedule specifies an exact start time and aggregated energy amounts be assigned to a number of underlying Prosumers. Such schedules are disaggregated to a number of schedules for each individual Flex-Offer it is composed of. This operation is denoted Flex-Offer disaggregation. Disaggregated schedules are finally forwarded to the Prosumers who initially offered flexibility. This Flex-Offer aggregation, scheduling, and disaggregation process is illustrated in Figure 1.

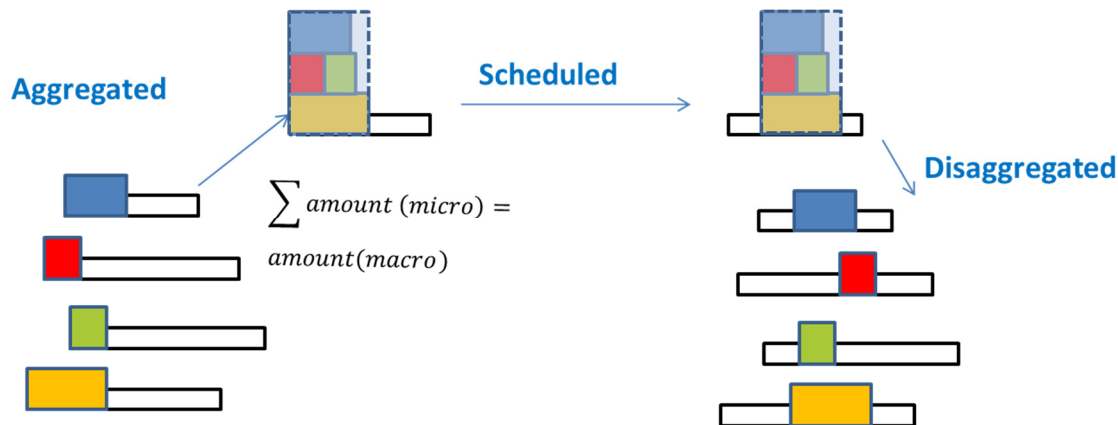

Figure 1 Aggregation/Disaggregation process

In this process, Flex-Offer aggregation and disaggregation is not a trivial task may be challenging due to a number of issues. First, there are three (conflicting) objectives that must be satisfied when generating aggregated Flex-Offers from simple (non-aggregated) Flex-Offers:

1. **There should be as few aggregated Flex-Offers as possible.** This ensures that the complexity of scheduling aggregated Flex-Offers is much lower than that of scheduling simple Flex-Offers. This makes it simple (and faster) for Aggregators managing (fewer aggregated) Flex-Offers.
2. **Aggregated Flex-Offers must capture as much flexibility as possible.** This ensures that aggregated Flex-Offers provide a large degree of freedom (e.g., to Aggregators) to shape flexibility based on aggregated Flex-Offers, e.g., to counter problems in the distribution grid.
3. **Disaggregation must always be possible.** While disaggregating schedules, it is important to respect all (time and energy) constraints of every Flex-Offer as well as to ensure that the energy amounts at every time slice are equal before and after the disaggregation. Therefore, aggregated Flex-Offers must not be “more flexible” than underlying simple Flex-Offers. Otherwise, it will not be possible to disaggregate schedules such that all constraints of individual Prosumers are satisfied, leading to significant imbalances.

Second, in the case of real-world Prosumers (e.g., EVs, HPs, dishwashers), aggregation has to deal with the variety of complex heterogeneous Flex-Offer instances. These Flex-Offer instances differ in terms of which *meta-data* (e.g., price, default/baseload schedule) is included and which *flexibility dimensions* (e.g., time flexibility, amount flexibility) and *constraints* (e.g., total energy constraints) are active. Aggregation has to ensure a careful treatment of such Flex-Offer instances having different meta-data, flexibility dimensions, and constraints.

Third, more practical features like *incremental aggregation* is needed, to be able to efficiently (re-) aggregate Flex-Offers when Flex-Offers need to be added, deleted, or modified. Incremental aggregation is able to efficiently accommodate these changes, avoiding the Flex-Offer (re-)aggregation from scratch.

In this work package, we developed three distinct Flex-Offer (dis-)aggregation techniques:

1. **Simple Flex-Offer (dis-)aggregation** – We developed techniques to (dis-)aggregate Flex-Offers with *start time* and *energy amount* flexibility dimensions and simple range-based flexibility constraints (e.g., *earliest start time - latest start time*, *minimum - maximum energy*, *minimum - maximum total energy*). Our aggregation techniques also handle meta-data associated with Flex-Offers, including *energy prices* and *baseline (default) schedules*. An example of such a Flex-Offer is shown in Figure 2. To aggregate such Flex-Offers, our techniques use Flex-Offer *similarity grouping*, which packs similar Flex-Offers

into the disjoint groups to limit flexibility losses. Further, *aggregate constraints* can be associated with aggregated Flex-Offers (e.g., aggregated Flex-Offer must be between 10-12MWh) and efficiently fulfilled with our techniques. The experiment results showed that our techniques can efficiently aggregated and disaggregate millions of Flex-Offers (Prosumers) on a single machine in seconds. More details can be found in [1].

2. Constraint-based (dis-)aggregation – We extended the aforementioned Flex-Offer (dis-)aggregation techniques to be able to efficiently aggregate Flex-Offers under distribution grid capacity constraints (computed by TVPPs from WP5). During aggregation, our extended aggregation technique packs and matches consumption and production Flex-Offers such that expected loads are minimized at a specific bottleneck location in the distribution grid. The effect of this type of aggregation can be seen in Figure 4. Here, two simple Flex-Offers f_1 and f_2 are aggregated in two different ways - with or without enforcing a distribution grid capacity constraint. In the first case (left of the figure), the resulting aggregate of f_1 and f_2 violates the constraint for all possible Flex-Offer instantiations (schedules), while in the second case (right of the figure), the resulting aggregate allows meeting the constraint for one possible Flex-Offer instantiation. As it can be seen in the figure, such constraint-based aggregation allows producing Flex-Offers that capture available flexibility of the flattened loads at a specific bottleneck location. Such Flex-Offers are useful, e.g., when trading flexibility under grid capacity constraints (CVPP trading under TVPP constraints). More details can be found in [2].

3. Dependency-based Flex-Offer (dis-)aggregation - We developed techniques to (dis-)aggregate so-called *dependency-based Flex-Offers*. Dependency-based Flex-Offers are suitable for more complex Prosumers (e.g., heat-pumps) – which offered flexibility changes over time and it is dependent on an internal system state (e.g., temperature). Typically, the state of such a system at the time interval t is (partially) driven by the energy consumed/produced energy at the time intervals $1..t-1$. Therefore, a dependency-based Flex-Offer captures energy amount flexibility at the time interval t in dependence to the total energy consumed at the intervals $1..t-1$, forming a 2D energy flexibility polygon at a particular time interval (slice) – see Figure 3. Our aggregation techniques are able to combine such dependency-based Flex-Offers, preserving much more of the available flexibility, compared to using simple Flex-Offers (Figure 2) for such complex Prosumers. Note, a simple Flex-Offer is the special case of a dependency-based Flex-Offer. More details can be found in [3].

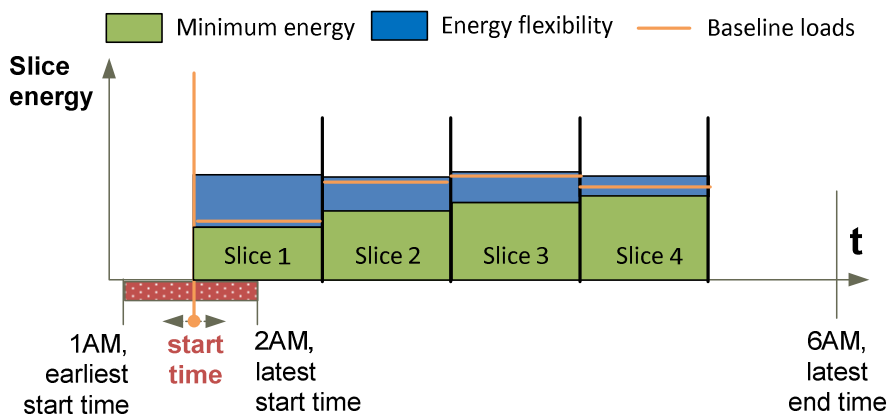

Figure 2 An example of a simple Flex-Offer

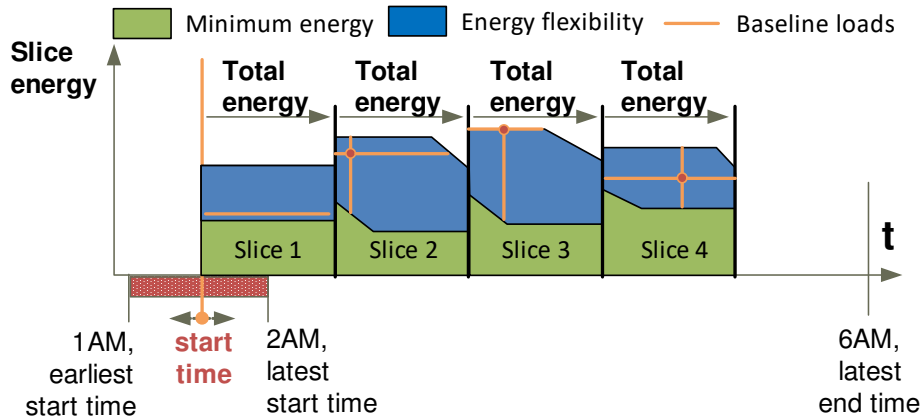

Figure 3 An example of a dependency-based Flex-Offer

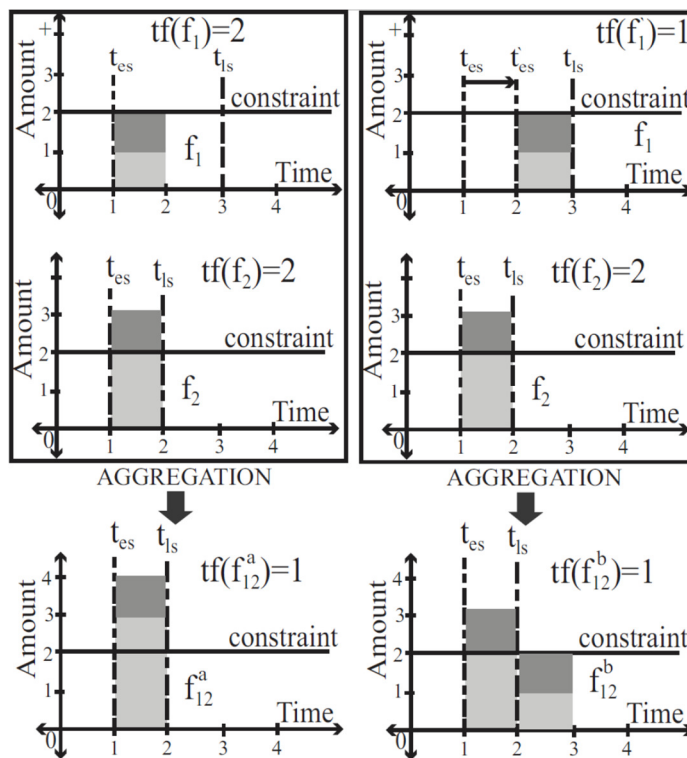

Figure 4 Two approaches to aggregate Flex-Offers f_1 and f_2 – with and without enforcing a constraint

In summary, our developed Flex-Offer aggregation techniques allow efficiently aggregating flexibility from millions of Prosumers - simple dishwashers to complex heat-pump - and then dispatching electricity to all these Prosumers according to individual schedules. These can be efficiently produced by using our techniques that effectively disaggregate a (global) schedule while respecting all Prosumer constraints and ensuring energy balance before and after disaggregation.

5.2 Aggregation and analysis system (ADS)

In this work package, we also developed an extensible flexibility aggregation and analysis system (ADS) for use by C-VVP operators and/or Aggregators (WP6). By utilizing ADS, its users are able to monitor, configure, (dis-) aggregate, optimize, and analyse their flexibility portfolios. ADS natively supports Flex-Offers and integrates the aforementioned simple Flex-Offer (dis-)aggregation techniques. In addition to Flex-Offer aggregation, its analytics features allow predicting and opti-

mizing electricity consumption (and production), as well as aggregating and analysing all types of data - metering, consumption and production, Flex-Offers, pricing, etc. to any level of detail.

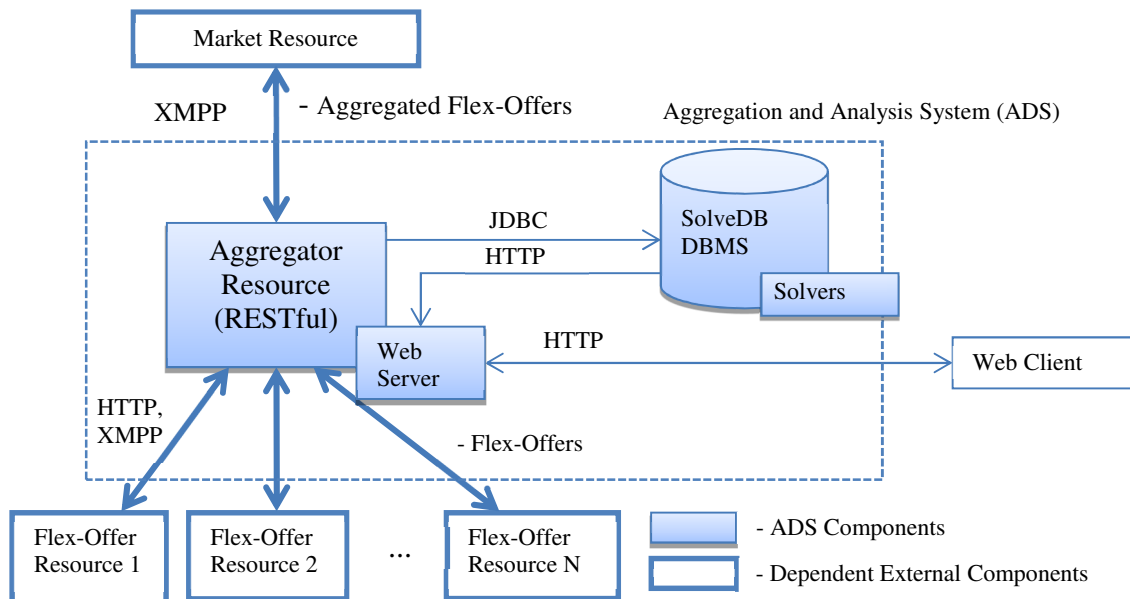

Figure 5 The architecture of ADS

The architecture of ADS is shown in Figure 5. As seen in the figure, ADS consist of two interconnected components: *Aggregator Resource* and *SolveDB-DBMS*.

Aggregator Resource handles all flexibility management operational tasks: (near) real-time Flex-Offer collection, (dis-) aggregation, schedule handling, market trading, and pricing. Aggregator Resource is connected with a number of *Flex-Offer Resources*. The latter components are typically installed at Prosumers premises and are responsible of generating Flex-Offers and consuming Flex-Offer schedules. Additionally, Aggregator Resource is connected with *Market Resource*. The latter component receives the Flexibility Market bids (as Flex-Offers) and distributes winning bids (as Flex-Offer schedules) from/to Aggregator Resource. Aggregator Resource also includes local HTTP (Web) server which offers a Web-based graphical user interface (GUI) serving as the front-end application of ADS.

SolveDB-DBMS handles all analytical operations of ADS. This component is based on our innovative general data management system (DBMS), denoted as SolveDB [4, 5]. SolveDB integrates a number of *standard solvers* for solving various general LP/MIP, black-box optimization problems. In the case of ADS, a number of additional *specialized solvers* were developed and installed for handling specific complex energy forecasting and optimization problems within ADS. SolveDB offers a Structured Query Language (SQL) interface for invoking these solvers based on data stored either in the physical database (tables) or the virtual database (views) with the Aggregator Resource' live data (e.g., latest Flex-Offers).

By utilizing all these components, ADS allow a number of flexibility management scenarios/use-cases, some of which are presented below.

State Monitoring and Configuration By utilizing ADS, the C-VPP users are able to configure the operation and monitor the state of the flexibility aggregation and analysis system. As exemplified in Figure 6 and Figure 7, the users are provided tools to acquire basic statistics (e.g., marginal costs, Flex-Offer count), analyse individual simple and aggregated Flex-Offers, and get overviews of the available flexibility (green area) as well as baseline (orange lines) and optimized

(red lines) energy schedules. Additionally, ADS generate and shows bills to be issues to each participating Prosumer in return for their offered flexibility, as seen in Figure 8.

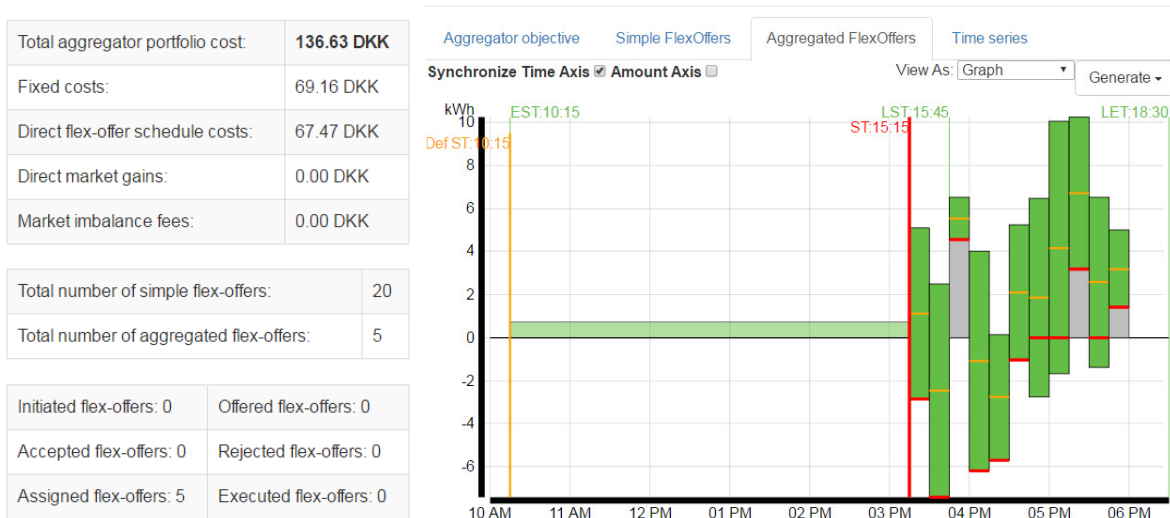

Figure 6 Examples of the ADS summary and Flex-Offer analysis windows

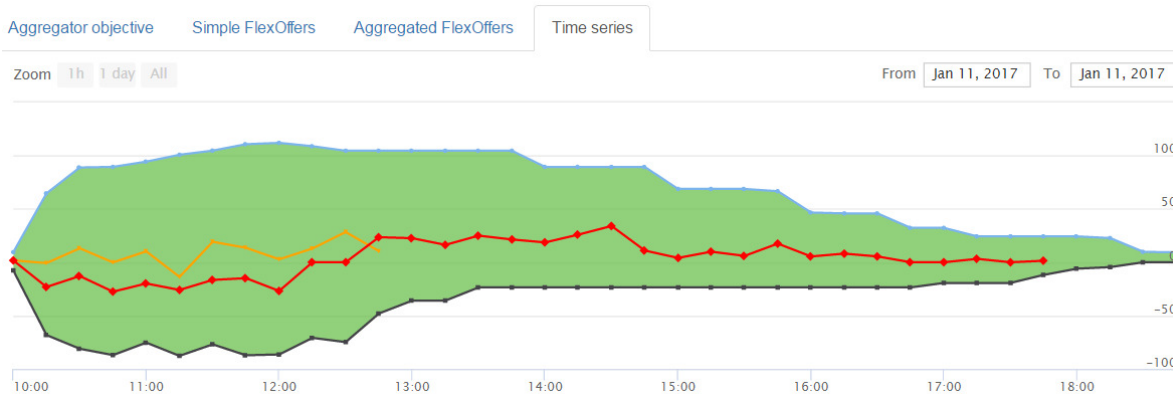

Figure 7 An example of the flexibility overview window

Customer: SELF

Item	Value	Price
Number of flexoffers	20	
Fixed reward for all flexoffers		10.00 DKK
Total Time Flexibility	182 time units (15 min)	18.20 DKK
Total Energy Flexibility	409.59 kWh	40.96 DKK
Number of default schedule deviations	20	2.00 DKK
The sum of stat time scheduling deviations with respect to the default schedule	142 time units (15 min)	28.40 DKK
The sum of energy deviations with respect to the default schedule	185.34 kWh	37.07 DKK
Total Reward		136.63 DKK

Figure 8 An example of the Prosumer bill window

Flexibility Analysis and Prescription By utilizing SolveDB, ADS allow analysing flexibility data using SQL-like queries, as exemplified in Figure . In this example, the given query instructs SolveDB to fetch all latest simple (non-aggregated) Flex-Offers from the (virtual) relation *fo_get_simple* from the Aggregator Resource, aggregate Flex-Offers using the aggregate function *aggregate* and default parameters, schedule the aggregated Flex-Offers using the function *schedule* and using the default objective, and finally disaggregating and executing schedules using the functions *disaggregate* and *execute*, respectively. As the output of this query, disaggregated schedules of the simple Flex-Offers to be executed are shown on the screen in one of several possible representations. Note, the evaluation of this complex query requires invoking the aforementioned Flex-Offer aggregation and disaggregation techniques, and well as optimization problem solving using two SolveDB solvers – a specialized Flex-Offer scheduling solver based on the general LP/MIP solver.

In SolveDB, complex ADS objects (e.g., Flex-Offers) are represented as JSON objects. Therefore, standard SQL queries involving traditional SELECT statements can be used to analyse all kinds of ADS data: operating schedules, market bids, operating parameters, marginal costs, metering data, etc. By using the "GROUP BY" and "WHERE" SQL clauses, Flex-Offer aggregation along specific dimensions (e.g., a customer or distribution network dimensions) is possible. By using a number of (standard and specialized) solvers installed in SolveDB, data predictions (e.g., time series forecasting) and optimizations are possible and natively supported by the SolveDB's query language based on the novel SOLVESELECT clause [4, 5].

Lastly, more complex analysis scenarios are possible with ADS, e.g., multi-perspective analysis where the joint effects for several markets are studied. For such scenarios, SolveDB can be configured as a multidimensional data warehouse for Online Analytical Processing (OLAP), which allows conveniently analysing large volumes of different kinds of multi-dimensional data.

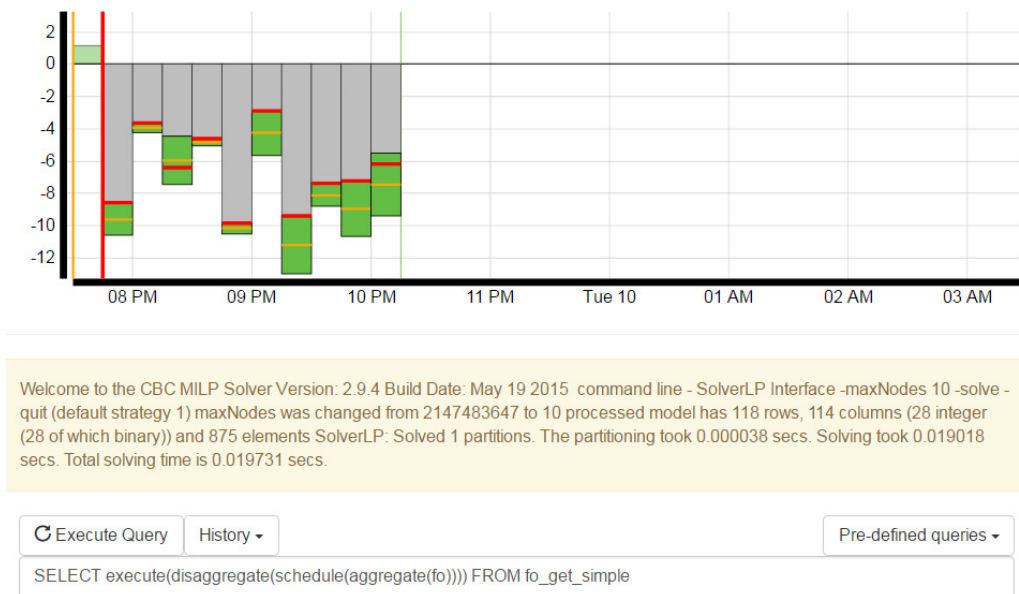

Figure 9 An example of ADS query window

Market Trading ADS offers a graphical tool to manually generate Flexibility Market bids based on the existing flexibility portfolio (Flex-Offers) and submit these bids for trading on the Flexibility Market. First, as seen in Figure 9, the tool allows selecting a time interval to match a specific trading interval of the Flexibility Market. For this interval, the ADS tool uses optimization to generate two schedules: *up-regulation schedule* and *down-regulation schedule* (the red and green

lines). These represent the maximum and minimum amounts of energy that can, potentially, be consumed/produced during the trading interval within the allowed flexibility bounds. For each of the (15min) time interval within the trading interval, the prices of both increasing and reducing loads are computed by contrasting the cost of scheduling Flex-Offers according to the up/down-regulation schedules with the cost of scheduling Flex-Offers according to the baseline schedule (the orange line). These prices can be visualized as the V-shaped (linear) functions (see the figure), approximating an expected *price* for a specific feasible energy deviation. The computed prices as well as the feasible up/down regulation amounts are packed into a new Flex-Offer. This Flex-Offer is used as a bid and can be sent to the Flexibility Market for selling available Prosumers' flexibility on the Aggregator behalf.

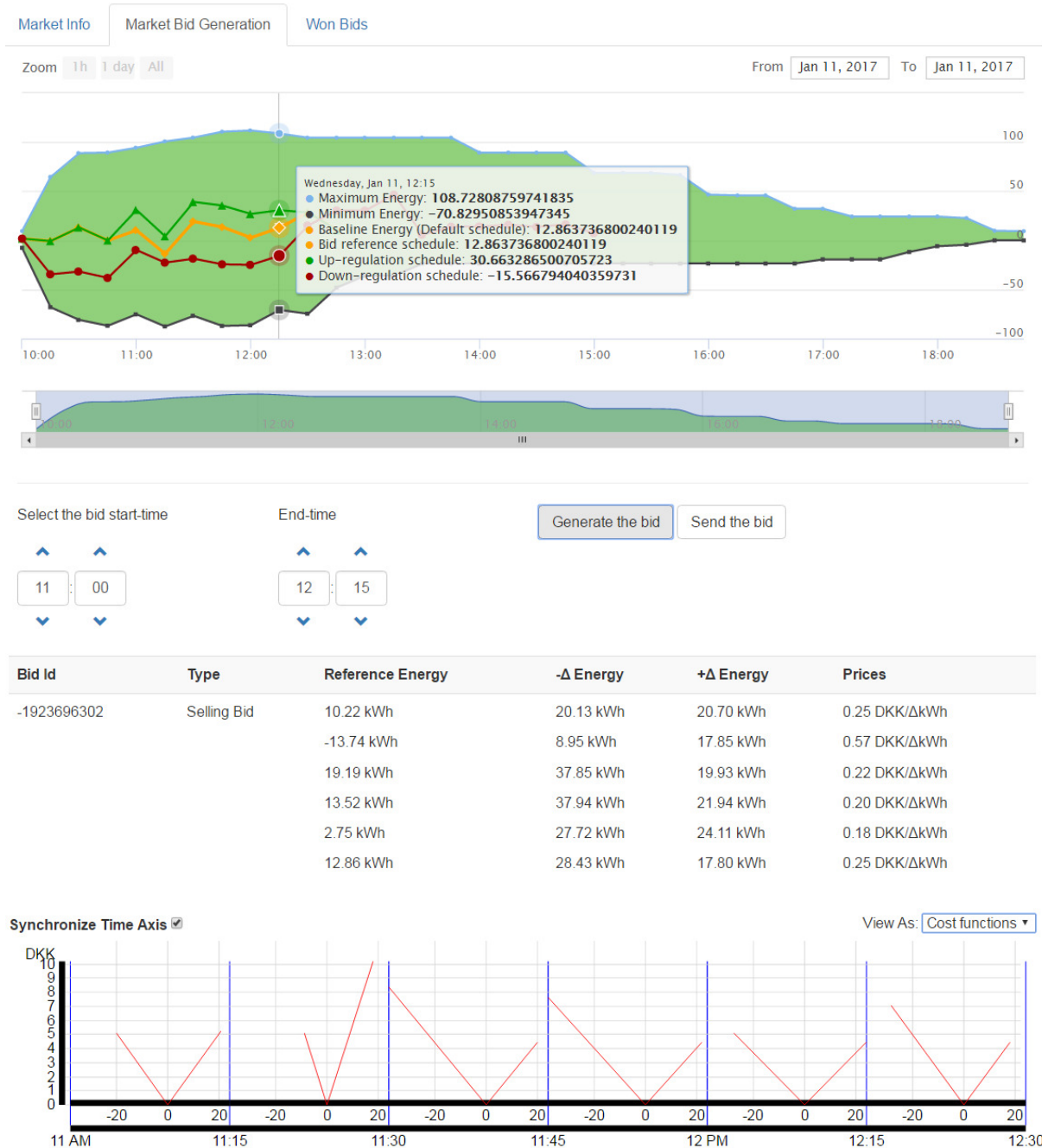

Figure 10 An example of ADS market bid generation window

ADS was developed in collaboration with the ARROWHEAD consortium and jointly published as an open source implementation [6].

In summary, WP3 developed a so-called *aggregation and analysis system* (ADS) for the use by Aggregators and/or C-VPP operators. ADS is an extensible system that facilitates the full range of flexibility (Flex-Offer) management and analysis tasks – from *data collection* to *data aggregation*, *prediction*, and *optimization*. ADS integrate many innovative features and techniques, most of which were developed in TOTALFLEX. These include Flex-Offer (dis-)aggregation algorithms, optimization and bid generation techniques, as well as SolveDB – our novel DBMS for data management and optimization problem solving.

5.3 Deliverables

Throughout the timeline of this project, WP3 produced a number of deliverables, which provided substantial inputs and/or served as intermediate milestones developing techniques and solutions presented in Sections 5.1- 5.2. Below, we summarize all these deliverables and explain how they contributed in evolving our solutions.

Deliverable 1: State of the art analysis – status of today, what has been done: The attached report [7] describes state-of-the-art technologies in the areas of multidimensional data warehouses, ETL processes, aggregation techniques, and multi-perspective analysis. Work presented in this deliverable served as a starting point developing the solutions presented in Sections 5.1- 5.2.

Deliverable 2: *Multidimensional data warehouse:* The multi-dimensional data warehouse [8], developed in the MIRABEL project, turned out to be well applicable in TOTALFLEX. Therefore, instead we decided to take a step further and develop *energy analytics extensions* (see Section 5.2) for a range of such energy data warehouses – from simple standard *normalized databases* to complex denormalised *multi-dimensional data warehouses*. Our extensions are provided as a number of specialized user-defined functions (UDFs) and solvers for our SolveDB system [4,5]. They allow users specifying and executing complex queries that (dis-)aggregate, schedule, and execute Flex-Offers – either operational or retrieved from a database. All our extensions are provided as part of the ADS implementation [6].

Deliverable 3: *Aggregation techniques for Flex-Offers:* The code and the accompanying documentation of our developed Flex-Offer (dis-)aggregation techniques are packaged and included [9].

Deliverable 4: *Aggregation techniques for specific dimensions, e.g., distribution network dimension:* This deliverable focused on Flex-Offer aggregation along the distribution network dimension with the associated grid capacity constraints. It is provided in the form of a paper [2] and a poster [10].

Deliverable 5: *Multi-perspective analysis:* The support for multi-perspective analysis is provided natively by our SolveDB-based ADS solution [4,5,6]. By utilizing energy analytics extensions as well as the full expressive power of SolveDB, users are able to analyse flexibility data from various perspectives as well as making flexibility operational by invoking disaggregation and execution. In some use-cases, access to such a querying and control interface can be granted to a range of users, e.g., TVPPs, CVPPs, and Prosumers, for studying joint effects or providing mutual benefit in order ways.

Deliverable 6: *Demonstrate aggregation in more dimensions from real Flex-Offers:* To limit flexibility losses, our developed aggregation techniques natively support aggregation of Flex-Offers in one or more pre-defined dimensions (including time, energy amount, time/amount flexibility). Additionally, Flex-Offer aggregation in arbitrary dimensions are possible with our SolveDB solution and developed energy analytics extensions. In either case, ADS allow choosing and configuring

dimensions used for Flex-Offer aggregation, and this functionality was demonstrated as an inherent part of ADS.

5.4 References

- [1] Laurynas Siksnys, Emmanouil Valsomatzis, Katja Hose, Torben Bach Pedersen: Aggregating and Disaggregating Flexibility Objects. IEEE Trans. Knowl. Data Eng. 27(11): 2893-2906 (2015)
- [2] Emmanouil Valsomatzis, Torben Bach Pedersen, Alberto Abelló, Katja Hose: Aggregating energy flexibilities under constraints. SmartGridComm 2016: 484-490
- [3] Laurynas Siksnys, Torben Bach Pedersen: Dependency-based Flex-Offers: scalable management of flexible loads with dependencies. e-Energy 2016: 11:1-11:13
- [4] Laurynas Siksnys, Torben Bach Pedersen: SolveDB: Integrating Optimization Problem Solvers Into SQL Databases. SSDBM 2016: 14:1-14:12
- [5] The SolveDB website on the Daisy home page: <http://www.daisy.aau.dk/solvedb/> , as of Jan-2017
- [6] Open-source implementation of the Virtual Market of Energy: https://github.com/lawrizs/ARROWHEAD_VME, as of Jan-2017.
- [7] Emmanouil Valsomatzis, Katja Hose, Torben Bach Pedersen: State-of-the-art analysis. Internal report. 2013. TOTALFLEX\WorkPackages\WP3 – Data Aggregation and Analysis\Deliverables\Deliverable3.1\State-of-the-art.pdf
- [8] Laurynas Siksnys, Christian Thomsen, Torben Bach Pedersen: MIRABEL DW: Managing Complex Energy Data in a Smart Grid. Trans. Large-Scale Data- and Knowledge-Centered Systems 21: 48-72 (2015)
- [9] Laurynas Siksnys, Emmanouil Valsomatzis, Katja Hose, Torben Bach Pedersen: The code and the documentation of the Flex-Offer Aggregation techniques. 2014. {TotalFlexCode.zip, WP3 - Aggregation Techniques.pdf}
- [10] Emmanouil Valsomatzis, Torben Bach Pedersen, Alberto Abelló, Katja Hose, Laurynas Siksnys: Towards constraint-based aggregation of energy flexibilities. e-Energy (Posters) 2016: 6:1-6:2

6 WP4 – User involvement within demand response

6.1 Introduction

The purpose of this work package was to involve potential users of flexible power production and consumption by analysing current usage in private households and user awareness of usage. Furthermore, this user involvement focused on the development of three Smartphone apps for connecting and controlling the Flex-Offers. We collected data in several ways. Usage and control data will be collected automatically through logging, and user behaviour and intention will be collected through several means, e.g. contextual interviews and different kinds of observations.

6.2 Deliverable 1: State of the art analysis

The first deliverable is a state of the art analysis of user involvement in electricity consumption or production. We examined scientific research papers published at relevant, prestigious human-computer interaction (HCI) conferences in the period 2003-2012. We included these conferences: the ACM Human Factors in Computing Systems (CHI), the ACM Nordic Conference on Human-Computer Interaction (NordiCHI), and the IFIP TC.13 International Conference on Human-Computer Interaction (Interact) and we selected papers, that dealt with aspects of sustainability and HCI research, e.g. electricity consumption. Our process identified and included a total of 39 scientific papers (30 papers from CHI, five papers from NordiCHI, and four papers from Interact). Basically, we noticed a growing number of published papers over the years, e.g. zero papers in 2003 over one paper in 2005 to ten papers in 2012. Our state of the art analysis produced two overall, significant findings namely 1) a strong focus on eco-feedback systems and 2) field studies and study duration.

Research Focus on Eco-Feedback

Firstly, several research studies (N=14) within HCI sustainability deals with eco-feedback systems. Eco-feedback systems are systems that provide users and house inhabitants with data and information on their energy consumption. The underlying assumption is that a lot of the consumed energy in private households is invisible and unknown, and therefore it is difficult to change or reduce consumption for private household inhabitants. An illustrative example of work within eco-feedback systems was done by Froehlich et al. [1,2], where they designed and evaluated prototypes that provided household participants with relevant water-usage information. Two different eco-feedback systems were examined, each exploring possibilities and consequences of using feedback displays. Even though the work by Froehlich is based on water consumption, their experiences are valuable and applicable to other types of private household energy consumption, e.g. electricity consumption. Furthermore, some studies found that real-time feedback is more efficient in terms of persuading people to change behaviour than e.g. weekly feedback. Finally, many of the papers mention the challenges and difficulties of sustained behaviour change and how to measure this change, but this remains unsolved in the research studies.

Real-World Studies of Eco-Feedback Systems

Secondly, it is quite evident that much HCI sustainability research employ field studies where developed prototypes are evaluated and studied in real-world contexts and sometimes over extended periods of time. 26 of the 39 included research papers conducted some sort of field studies lasting from a few days to several years. Our findings showed that almost half of the field study papers involved studies with a duration less than a month (N=11) whereas eight papers reported from studies of more than two months e.g. [3,4,5,6,7]. It seemed clear that conducting proper longitudinal studies of developed consumption prototypes is quite challenging for a number of reasons, e.g. duration of research projects or PhD studies or engagement with households over such extended periods of time. However, most papers acknowledge that we need such stud-

ies in the future to better understand sustained behaviour and changes over time. Also, we found that several data collection methods are applied in these studies, e.g. interviews (N=18) or questionnaires (N=15), but interestingly a high number of studies (N=15) include data logging as data collection technique to collect actual data on interaction with the developed prototype and also consumption data.

This deliverable is further explained and illustrated in (Deliverable 1: Work Package 4: User Involvement)

6.3 Deliverable 2: Analysis of power consumption and production

The second deliverable concerns an analysis of power consumption (and production if applicable) for private Danish households. The analysis is not concerned with figures on e.g. spend kWh and when specific electricity is consumed or produced, but investigates how electricity is consumed in terms of household practices and actions with the purpose of understanding how we can support (through technology) flexible consumption in the future. The activity behind this deliverable is closely related to deliverable 3 in this work package, and therefore the description of these deliverables was combined in one document.

We recruited 12 Danish families with 22 inhabitants (adults and children) for our study (12 households). Four of the households were recruited in collaboration with Modstrøm (a Danish electricity provider) and the remaining eight through personal contacts. All household members except of the children under 15 years and two other individuals took part in the study and we conducted interviews based on cultural probes. The majority of the households (n=8) had never changed their electricity provider, while the remaining four had changed their provider within the last two years (2010 to 2012). Based on interviews and data analysis, we identified a number of themes that characterized their electricity consumption.

Practices versus Actions

Not surprisingly, the 12 households shared many similarities in practices (macro-level), e.g. cooking, shopping, washing, cleaning etc., but the actions (micro-level) that compromise these everyday practices differ quite significantly from one household to another. In this sense, we found that the set of actions highly defined how their electricity consumption practices look like. As an illustrative example, the differences in actions were quite vigorously illustrated through their use (and lack of use) of tumble dryers, which is an electricity consuming device. All households except four had their own tumble dryer. In one household, a young couple used their tumble dryer for almost their entire set of clothes usually for practical reasons. They primarily did their laundry during weekends due to lack of time during the week, however occasionally they would wash Monday to Friday if one of them needed to go travelling or if they ran out of towels. They further exemplified that they would bundle up several loads from the washing machine for the tumble dryer - "the washing machine are running a lot more than the dryer". They lived in a 3-bedroom apartment on the 1st floor, with their own washing machine and tumble dryer located in the bathroom. They had access to a backyard although it is often filled with cars furthermore there is a basement room that acts as a common drying room. Even though it does not seem like it is due to a lack of space or bottleneck issues with drying racks it was not convenient, and as they states "just easier" to use a tumble dryer. Another household (married couple with two smaller children) strongly indicated the direct opposite attitude towards using tumble dryers (even though they had one in their own laundry room) and described the use of a tumble dryer as "simply gorge". They never use the dryer except in rare situations and according to the family themselves, this would only happen approximately 6 times a year. In summary, our study showed that households actions were highly diverse that complicates flexible electricity consumption.

This deliverable is further explained and illustrated in (Deliverable 2 + Deliverable 3: Work Package 4: User Involvement)

6.4 Deliverable 3: Analysis of user awareness of power consumption

The third deliverable concerns an analysis of user awareness of power consumption (and production if applicable) for private Danish households. This is, of course, closely related to the analysis of power consumption as illustrated in deliverable 2. Hence, the analysis was based on the same empirical data. For participants, data collection, and data analysis, please refer to deliverable 2 (above).

Power Consumption Awareness

Firstly, most households had an awareness of their power consumption. Most of the participants had explicit thoughts and ideas on sustainability and how they should act when it comes to consumption of especially electricity, but part of their actions was in fact unsustainable and directly challenged their intentions of acting in a sustainable manner. Some of these households (H5, H6, H9) expressed that based on their upbringing they always, or at least most of the time, remember to turn off the light when leaving a room. This pro-sustainability behaviour continues in the discourse when talking about the environment and different initiatives to make our impact on nature as little as possible. Many of the households also explicit stated that when it came to consumption, their intentions were to choose the most sustainable alternative in order not to use an excessive amount of resources. As already discussed, the way H12 used their tumble dryer was based on what they defined as an acceptable level of consumption. Here their practice intentions were highly sustainable. But these intentions were challenged by contradictory and unsustainable actions.

Even though the members of the household had shown highly insightful about their consumption and knew how to reduce it, they accepted a burning light in the hallway. It seems that since the volume of electricity consumed by energy saver bulbs is relatively low they did not make it a priority to turn it off, as they would with the bulbs that consumed a relatively high volume of electricity. Furthermore, they choose to do as much of their laundry as possible during the night time, since the demand of electricity is lower than during the day, thus the electricity consumed are free.

Sustainable Intentions

Secondly, most households made choices that went against their intentions to act sustainably. During the cultural probe study period, they were educated in the electricity demand cycles, and expressed that they choose to use the washing machine during the night both to save money on their monthly bill but also to take advantage of the 'green' electricity produced during the night. Contradictory they also had high electricity consuming lava lamps in each of the children's bedroom that were sometimes turned on all through the night. The household's intentions about changing to energy saver bulbs and doing laundry during the night time were good sustainable intentions, when asked about their motive they stated that it was equally economical and environmental, but as the examples illustrates some of the actions does not comply their sustainable intentions.

It was not only when it came to light that the actions from the households did not comply with their otherwise sustainable intentions. One household (H6) turned off all off her devices whenever she did not use them, which meant no standby consumption. She described that it was "*an inheritance from when [she] was a child*", and just something she had always done to reduce her consumption. Sensors had also been installed for the outside light to prevent it from burning all night and as a tool for keeping unwanted visitors away. As a contrast to her otherwise sustainable

practices, the radio in the kitchen was turned on from the minute she arrives home from work, to the minute she left for work again in the morning, including the night when she slept. In addition to the radio, the television in the kitchen was turned on almost from the minute she arrived home until she went to bed because "*this is how I keep up with the news*". This practice was not only when she was alone, but sometimes also when there were guests, then it was used as ambient noise and entertainment.

Lack of Economic Incentives

Thirdly, most households were missing a notable economic incentive. The general stance formulated by the participants was that electricity consumption, at a large, was barely effected by economical incitement. Hence the economical incitement by reducing electricity consumption is not big enough to make a household change their current practices, even when an economical gain is within reach.

Four of the participating households were customers at Modstrøm and had "free" electricity during the night, the price was DKK 0,- pr. Watt, from midnight to 6 AM. Even though they were well aware of the 'free' electricity during the night, only two of them had made changes in their consumption prior to the study, to gain from the 'free' electricity. H1 and H2 mainly used their washing machine, dishwasher and chargers for laptops and mobile phones during the night. That is remarkable since all of the households that are customers at Modstrøm changed because of economic reasons

The majority of the households directly commented on the missing incitement to reduce or change their consumption, even when asked how much they imagined they could save by changing their electricity provider or changing consumption, they estimated a yearly saving on DKK 600 to 1.000 (USD \$140 to \$175). This was still considered "to much of a hassle",

It seems like a saving on DKK 600 to 1.000 a year, compared to the total price of a household including mortgages, fuel, groceries etc., just was not enough to change much behaviour, since it would not make any noticeable economical gain.

This deliverable is further explained and illustrated in (Deliverable 2 + Deliverable 3: Work Package 4: User Involvement)

6.5 Deliverable 4: Functional Smartphone App

This deliverable deals with designing a functional smartphone application for controlling and utilizing flexibility of electricity consumption in private households. In the application, we promised to design one functional app, but we actually designed and implemented three different apps with three different objectives within flexible electricity consumption. We developed three different smartphone apps that investigates or utilizes aspects of flexible electricity consumption on different ways namely as eco-feedback (PowerViz), eco-forecast (eFORECAST), and eco-interaction (HeatDial).

PowerViz: An Eco-Feedback App

PowerViz is an always-on eco-feedback display developed for a mobile platform and was developed in the multi-platform programming language Haxe. The design of PowerViz was based on experiences from e.g. Froehlich et al. on water feedback. The user interface consists of five individual screens with designs based on the design principles. The feedback system was developed as an application for an always-on eco-feedback display. This was primarily to accommodate the accessibility constraint, where users easily can be informed when passing by the display. In the following sections, each of the designs are described briefly, and the use of the two visualization types as mentioned in Pierce et al. is described.

The users can view their consumption over time using historical data (see figure, left). The timed usage view uses graphs to show the total consumption and usage for each room in the house. The graph has different colours so that users can easily compare consumption of each room and get an overview of where it occurs.

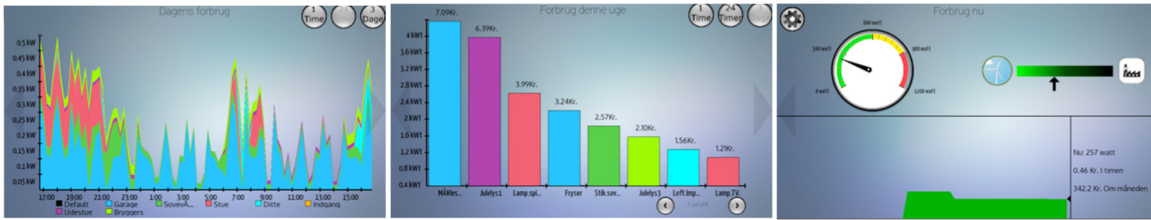

Figure 1 Timed usage based on rooms and consumption over time (left) and appliances organized by their consumption (middle)

To give the users a better understanding of what consumes the most energy, a screen was made to visualize consumption on appliance level (see figure, middle). This screen shows two types of information in a coordinate system. This information includes the watt per hour consumed by a given device in a specified time period and the cost of such consumption. We have implemented buttons so that the users can browse between different devices. This was done to save space so that the system would scale better. The devices are furthermore sorted so that the device that uses the most will be the first one shown. The rest of the devices are then sorted in decreasing order. We assume that the most power consuming devices are most relevant to the users. In addition to showing historical data a screen was implemented to visualize the current consumption. This view includes three types of information. First, the current consumption is illustrated by using a speedometer, which is divided into three: Low consumption (Green), average consumption (Yellow) and high consumption (Red). Secondly the origin of the energy that is consumed. This was implemented as a meter with a colour code green for sustainable energy, e.g. wind, and black for unsustainable energy, e.g. coal. The last information showed on the current usage screen combines the two former pieces of information into a graph which shows historical data (height of the graph) and the origin of the electricity (colour of the graph). The idea behind this was to give historical information about the current consumption and its origin. This is supplied with the price of the electricity and shows the cost if they continue to consume the same amount of energy. The price is displayed on hour and month basis. The on/off screen is quite different from the other screens. Instead of visualizing consumption measured in watts or price, this screen shows when an appliance has consumed energy. The purpose of this screen is to give the consumers an overview about when something consumes energy.

eFORECAST: An Eco-Forecast App

eForecast is similar to previous ideas on forecasting but extends with several sources of forecasts and a system deployment. We designed and created eForecast to present recent usage, expected usage, electricity price, availability of wind power, and expected peaks in demand. eForecast is designed to run on an always-on tablet that can be placed in a suitable place in the home e.g. on a shelf or mounted on the wall. eForecast is not meant to include a lot of detail about past electricity usage. Instead the aim here is to empower people to respond to some of the external factors that influence the sustainability of electricity use.

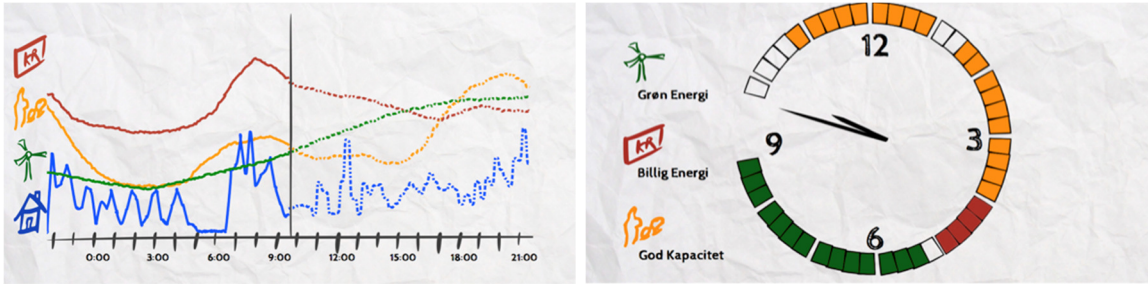

Figure 2 eFORECAST where the user can see historical consumption data on the left and a forecast of electricity prices (right)

eForecast consists of six different screens, which the user can swipe between. Four of these screens display different visualizations of the household's recent electricity usage combined with forecasts from external sources. The fifth screen shows all forecasts combined. The vertical line in the middle indicates current time, with the last 12 hours represented on the left (solid line), and the forecast for the next 12 hours on the right (dotted line). In this example, it can be seen that the household has an expected peak of electricity use just after 12:00 and an increase in use after 19:00 (blue), and that there will be an increase in available wind power during the afternoon, levelling out after 18:00 (green). Price will go down until 17:00 (red), and demand is expected to go up after 15:00 (yellow). It can also be seen that there is a "sweet spot" between 16-17:00 where price and demand is low while the availability of wind power is high. Based on this, one might attempt to delay the 12-13:00 peak in use by a few hours.

In order to provide people with a simple overview, a dedicated screen displays a clock with a simplified indication of upcoming time-periods where it would be favourable to use electricity – either because it is green, cheap, or in good capacity.

eForecast has two components: a client application that displays the data to the user, and a server that collects and manages data from different sources. Electricity use data is collected from a home automation system, ZenseHome, which contains real-time measurements from the individual power outlets in the house. This is used to record, display and predict usage in 15-minute intervals. Electricity price data is collected using web scraping of Northern Europe's leading power market, Nord Pool Spot, where electricity pricing is negotiated at least 12 hours in advance. Data on the expected availability of wind power is based on weather forecasts from the Open Weather Map weather service. The expected demand on the power grid is calculated on the basis of data about similar households' combined patterns of consumption, taking into account the day of the week, and the month of the year. The household's expected energy demand is calculated in the same manner but based on their own history of use.

HeatDial: An Eco-Interaction App

We designed HeatDial – a smartphone app that enables electrical heat pump owners to set the inside temperature of their house and discover the trade-offs between comfort and cost. Electrical heat pumps make an interesting use case for studying eco-interactions beyond user scheduling for several reasons. Firstly, to produce heat, heat pumps use a considerable large volume of electricity. Secondly, although they harness this electricity effectively, they become a more attractive green alternative, if the electricity utilized is produced from renewable resources. Lastly, as it is possible to externally control the heat pump, we can intelligently control the running times of the heat pump.

Our primary design challenge with HeatDial was to materialize an eco-interaction design that translates the concept of shifting energy usage to the mechanics of running a heat pump. Most heat pumps regulate heat after a set temperature, typically specified by a user. The heat pump will run in hourly intervals to maintain this temperature, normally automatically scheduled by

heat pumps manufacturers. In the HeatDial system, the heat pumps will be intelligently controlled to run at times sustainable favourable while trying to maintain a comfortable indoor temperature. The underlying assumption behind this approach is that most users do not care about the exact running times of their heat pump, just as long as they are comfortable when indoors.

However, a system designed to intelligently control thermal comfort will need to accommodate for the complexity of domestic heating, as thermal comfort is something that is contextual, personal and temporal. While several examples have utilized occupancy observations and predictions to say something about the occupants' temperature comfort level intelligently, the HeatDial prototype addresses this design challenge differently. Instead of deriving comfort preferences from data sets, HeatDial allows a user to express a comfort zone of temperatures, as a temperature tolerance range, illustrated in the HeatDial interface in the figure.

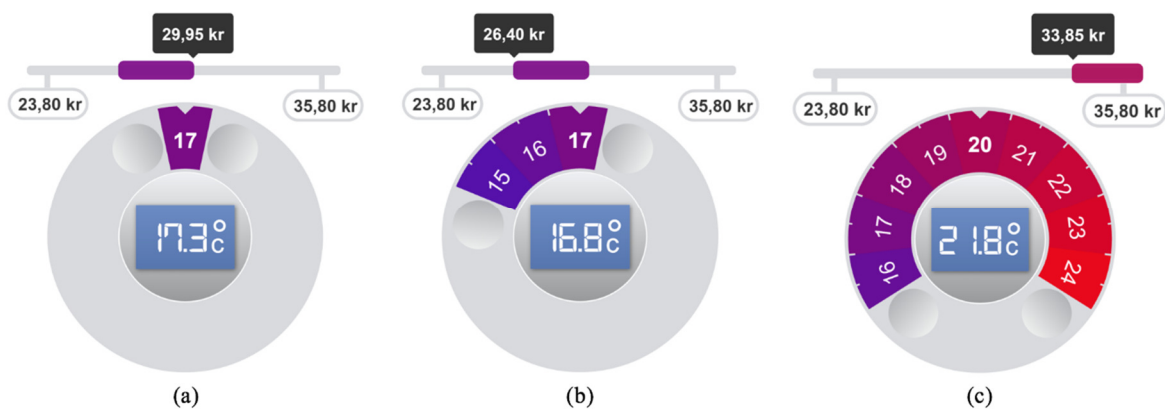

Figure 3 HeatDial in three different settings with price and price ranges for the next 24 hours: Preferred temp. set to 17°C with no tolerance (a), a lower boundary set to 15°C (b), and preferred temp. set to 20°C with the widest possible tolerance (c)

Based on the temperature tolerance range and other contextual factors, such as; local weather forecasts, temperature measurements from inside and outside of the house, a mathematical model of the transport of thermal energy in the houses, predicted grid demand, and electricity prices, the intelligent system automates a schedule of best possible running times for the next 24 hours. With this design, we aim to address the challenge of involving users in controlling contextual and temporal elements in the home - regulating the temperature, while the autonomous intelligent system will take advantage of outside elements such as weather, price, and grid demand.

HeatDial allows users to specify the temperature tolerance range, by letting a user set three temperatures; namely the preferred temperature, and the boundary minimum and maximum temperatures, in one degree Celsius intervals. The preferred temperature is what the heat pump system aims as the ideal temperature. This temperature is shown at the top of the dial, under a little downward notch, as illustrated in Figure 3 where it is set to 17°C. Dragging the gradient coloured dial left or right sets the preferred temperature, inspired by the interaction with a traditional domestic heating thermostat. The boundary minimum and maximum temperatures signify the temperature tolerance range that the heat pump system is allowed to operate within. The user sets the boundary temperatures by dragging the indented grey adjuster dimples on either side of the temperature dial. This is illustrated in Figure 3 where the minimum tolerated temperature is set to 15°C, with the preferred temperature still being 17°C, and in Figure 3 where the minimum is set to 16°C and the maximum to 24°C. The larger the range between boundary minimum and maximum temperatures, the more optimally the system can schedule the heat pump to run, resulting in a lower price, as seen in Figure 3.

HeatDial instantly displays calculated estimated monetary cost and possible price ranges for the current setting. This is displayed above the temperature dial in Danish Kroner (1 kr. = US\$ 0.15). The two prices displayed at either end of the bar are the lowest and highest possible cost for using the heat pump for the next 24 hours that the user can achieve by changing the settings of HeatDial. In the example in Figure 3 this range is between 23,80 kr. and 35,80 kr. The lowest cost can be obtained by lowering the preferred temperature, while increasing this temperature results in higher cost. The price of the current temperature setting is displayed in the black box above the bar (e.g. 33,85 kr. in the figure 3). The price range calculation also makes it possible for the user to see opportunities for cost saving, by allowing the heat pump to work within a wider temperature range rather than at one preferred temperature. This is indicated with the coloured rectangle hovering over the grey bar. This rectangle illustrates the price range that is achievable for the current preferred temperature by allowing fluctuations. In the figure, the price bar shows that the preferred temperature of 17°C will cost 29,95 kr., but the purple rectangle also shows that this cost could be reduced toward the lower end of the range. This reduction can be achieved by lowering the minimum boundary temperature, as is illustrated in the figure 3 where this has been set to 15°C, resulting in the cost being reduced to 26,40 kr. Figure 3 shows how raising the preferred temperature to 20°C results in a higher cost, but that setting a wide temperature tolerance results in the lowest possible cost of 33,85 kr.

This deliverable is further explained and illustrated in (Deliverable 4 in User Involvement)

6.6 Deliverable 5: Demonstration of smartphone App in field trials

All three applications (illustrated in deliverable 4) was employed in field studies. In this summary, we focus on the deployment of HeatDial as we consider this app the most central in terms of flexibility in electricity consumption and was studied over the longest period of time. The two other field deployments can be found in (Deliverable 5: Deployment).

In the HeatDial study, we aimed to investigate assisted shifting over a prolonged period of time and in the real world, we conducted a series of 20 interviews over 18 months. 4 households took part in the study over 18 months. The study started with 8 in-home semi-structured interviews lasting between 45 and 115 mins, two for each household. In the first introductory interview, we mainly asked questions regarding their current heating practices, how they interacted and understood their heating system and about their environmental awareness. We also introduced them to the HeatDial prototype and the purpose of shifting in the study. Prior to the first in-home interviews, we also conducted a conversational technology tour [3]. On this tour the participants guided the researchers through the setup of their home heating system and heat pump and how they currently interacted with the system. There were two reasons for conducting this tour. First, we, the researchers, gained insight into how individual householders would interact and perceive this complex heating setup. Second, it gave the householders an opportunity to unfold implicit routines and perceptions regarding their interaction with the system. During the tour the researches took notes and photographs of the technology. We conducted the second interview after 6 months. In this interview, we mainly focused on how the participants experienced interaction with the HeatDial app. Twelve months into the study we recruited a further 4 households (Household E to H). We conducted the same introductory interview, and these interviews were conducted by phone. They lasted between 30-60 minutes. During the entire study, we logged interactions with the app. In the last two months, we also sent out text messages to each household, asking them questions about how they used the app, with information reminding them about features in the system. These logs and answers from the text messages guided the last final interviews.

Our findings stem from all 20 interviews with the households and the interaction logs. While interacting, and regulating the temperature is not something that is done on a regular basis, we still logged a total of 810 interactions with HeatDial. Household B, D, E and F had over hundred

interactions (household B had over 300), while household H had the lowest with 20 interactions. The effect of shifting was harder to pinpoint down to a number, but NG who maintained the automatic manager, reported that during our study, the 8 households managed to save 4.4% in cost, due solely to shifting electricity consumption to when the price was cheap on the electricity market. We found that all households reported that getting a system to assist with scheduling running times to shift heat pump consumption was a task they would rather avoid having to do by themselves. The feeling of convenience also influenced the households' willingness to let an automatic manager handling shifting tasks. A willingness that continued to be present in all the households throughout the duration of our study, as none of them turned the automatic manager off on purpose during the 6 or 18 months that they were living with the prototype. Our findings showed that specifying temperatures on HeatDial was closely associated with interpretations of comfort and conventions. While all our households were willing to let an automatic manager shift heat consumption to more favourable times, letting the system have too much of an influence on them feeling comfortable was clearly a non-negotiable factor for them: "so if you can somehow move some power to where it is more appropriate then it is fine with us. As long as it does not destroy the comfort for us" (Household B).

This deliverable is further explained and illustrated in (Deliverable 5 in User Involvement)

6.7 References

- [1] Froehlich, J., Findlater, L., Landay, J.: The design of eco-feedback technology. In: CHI '10, pp. 1999-2008. ACM Press, New York (2010)
- [2] Froehlich, J., Findlater, L., Ostergren, M., Ramanathan, S., Peterson, J., Wragg, I., Larson, E., Fu, F., Bai, M., Patel, S., Landay, J.A.: The design and evaluation of prototype eco-feedback displays for fixture-level water usage data. In: CHI '12, pp. 2367-2376. ACM Press, New York (2012)
- [3] Erickson, T., Podlaseck, M., Sahu, S., Dai, J.D., Chao, T., Naphade, M.: The dubuque water portal: evaluation of the uptake, use and impact of residential water consumption feedback. In: CHI '12, pp. 675-684. ACM Press, New York (2012)
- [4] Strengers, Y.: Designing Eco-Feedback Systems for Everyday Life. In: CHI '11, pp. 2135-2144, ACM Press, New York (2011)
- [5] Gabrielli, S., Sabatino, A., Munoz, J., Marchesoni, M., Mayora, O.: BeeParking: feedback interfaces for collective behavior change. In: CHI '11, pp. 2145-2148. ACM Press, New York (2011)
- [6] Aoki, P.M., Honicky, R.J., Mainwaring, A., Myers, A., Paulos, E., Subramanian, S., Woodruff, A.: A vehicle for research: using street sweepers to explore the landscape of environmental community action. In: CHI '09, pp. 365-374. ACM Press, New York (2009)
- [7] Fitzpatrick, G., Smith, G.: Technology-Enabled Feedback on Domestic Energy Consumption: Articulating a Set of Design Concerns. In: Pervasive Computing (IEEE), pp. 37-44. IEEE (2009)

7 WP5 – Development of a grid load model and Technical VPP (TVPP)

7.1 Executive summary of WP5

The recent developments in electric power system have directed towards electrifying the heating and transportation systems. This is prevalent in the form of using large sizeable flexible loads like heat pumps and electric vehicles which are widely introduced to the local electric distribution grids. Unless coordinated and controlled in an appropriate manner, these loads could lead to congestions in distribution grids which are not designed for supplying power to such large units. To overcome this challenge, one of the key options the distribution system operators (DSO) could apply is to transform the distribution networks to a "smarter and active" grid which is characterised by implementing advanced control and automation. This in turn facilitates the use of local and flexible generation and loads resulting in economic and sustainable benefits to prosumers, grid companies and electricity traders.

These grid modernization schemes to accommodate load and generation control of local units is a ground-breaking step, however, it is impaired by many practical difficulties. The existing power flow tools that can calculate the grid congestions are time consuming and are hard to use for reliable online calculations for finding the state-of-grid of several active nodes of the future distribution grids. Therefore, development of simplified and adaptive models of distribution network is essential which should take into account the future expansions of the grid. The model should be based on the use of few online measurements, historical data, and appropriate measurements from flexible units.

In this project work package, such a model is built on integrating different modules developed on generic load forecasts, estimations tool for flexible load/generation from minimum possible metering data, on-line load distribution monitoring and control algorithms for flexible electricity market which treat consumer flexibility in a fair manner. From the overall TotalFlex project perspective, these modules form the full technical implementation and potential of TVPP, and eventually ensure an efficient and secure grid operation by utilizing active load and generation resources. This project was conducted as research and development work and the results from the models in this work package are demonstrated by simulations.

The outcome of the research work can be used by the DSOs to forecast and understand the load distribution of their distribution networks, detect any upcoming congestions and bottlenecks, estimate the available flexibility to mitigate them, and, eventually, schedule this flexibility. This in turn can help them to utilize the existing grid capacity and delay costly grid reinforcements. With an advanced knowledge of reasonable amount of flexible power and its transfer capabilities through distribution grid for a given time, these intelligent modules will also help the commercial players to schedule and trade electricity in an economic manner at different timeslots in the market place. The major contributions of this work package are briefly described below.

1. A simple, generic, and automated load forecasting technique based on sequential pattern mining was devised. This non-parametric approach can be used at various aggregation/disaggregation levels by the DSO to detect upcoming grid loading complications.
2. A novel non-intrusive load monitoring (NILM) method targeting load intensive flexibility devices was conceived. This technique is generic for the most cases and occasionally requires adjustment at the classification step depending on the flexible device type.
3. A framework for allocating power meters in a top down disaggregation perspective was formulated. It was established how this approach can result in an online hierarchical load monitoring frame for radial distribution systems. Furthermore, the same algorithm can be

used to determine the grid areas for trading aggregated flexibility on local flexibility markets.

4. A two-stage control algorithm to define the required flexibility services by the DSO was developed. Well-known techniques were combined in an innovative way to define both a centralised and a decentralised control scheme, which are compatible with the operating times of contemporary energy markets where special focus was given on the fair activation of flexibility in the network.
5. A simple optimal strategy to quantify aggregated flexible demand and the process of time-shifting of flexibility to another time-slot to operate the active distribution system within secure operating limits is devised. Simulations are carried out and demonstrated in Danish low voltage electric grid for summer and winter weeks.

7.2 Project Objectives

The main aim of this work package is to develop simplified grid models characterizing the load situation of the low voltage distribution network and a Technical VPP (TVPP), which aggregates and predicts local generation, load and capacity issues for multiple grid radials and exposes this on the market place. The objectives are realized by the following main tasks.

- Set up of simplified adaptive models of distribution grid for the prediction of loads and loading in the electricity grid to realise TVPP functionality in flexible electricity market.
- Develop short-term load forecasting and flexibility estimation techniques compatible with few measurements and low metering time-resolutions.
- Develop power meter allocation method for robust online monitoring of distribution grids.
- Develop a multi-level control strategy to manage and activate load flexibility suited to modern electricity markets and alleviate grid congestion in distribution networks.
- Proposals for information exchange between TVPP and CVPP agents to handle techno-economic aspects of flexibility in a flexible market environment.
- Demonstration of aggregated Flex-Offer generation in response to grid congestions in low voltage distribution networks.

7.3 Results and Dissemination of results

The work accomplished in this work package is mostly conducted in the form of a Ph.D. research by Konstantinos Kouzelis and results are available in his Ph.D. thesis [1]. The thesis is a summary report based on 2 journal papers (one published [2], and one submitted [3]) and 5 conference papers [4]-[8]. The work on aggregated Flex-Offer estimation and its simulation was developed and demonstrated by Post Doc Pavani Ponnaganti. The submitted conference paper [9] is based on the outcome of her work. The main project tasks and its results are described in the following sub-sections.

7.3.1 State-of-the-art analysis

This section describes the survey of different models and methods that can enable TVPP to implement efficient grid tools in a smart grid context to help DSOs to meet the operational and planning challenges in their grids. The first part of the state-of-the-art analyses deals with load forecasting models. It has been typically done at an aggregated level, applied at transmission or sub-transmission level with less forecast errors and high degree of complexity. These models are unsuitable to local distribution grids and for aggregation of demand from few consumers, where the randomness is quite high, so large forecast error is expected. Therefore, short-term forecasting methods that can capture the characteristics of the local load and flexibility models in distribution grids are essential. Such methods consist mostly of parametric and non-parametric techniques. A non-parametric forecast model based on sequential patterns that do not depend on variable estimation is proposed in this work. It is a more flexible approach than the parametric

techniques to be in agreement with a short prediction range and the scalability requirements of load forecasts in distribution grids.

From smart grid perspective, for the TVPP to implement demand response, one of the major implications is regarding the management of huge data handling, data storage and communications, as well as data security issues. This necessitates the DSOs to use robust flexibility estimation methods to estimate relevant variables with minimum data for quantifying the demand flexibility in the grid. Non-Intrusive Load Monitoring technique is a typical approach used for load classification and identification purpose from aggregated measurements, where aggregated measurements are disaggregated to specific device level power patterns. However, it is not fully compatible in relation to the new challenges from huge data handling and granularity of smart meter data. Therefore, a novel stochastic NILM method is applied in this work where demand profiles of flexible and non-flexible consumers are compared to estimate the flexible consumption, and this method to a great extent is independent of a selected time frame.

One of the important elements of TVPP is the level of monitoring possible on the status of the distribution grid and on its loading to alleviate any grid limit violation problems. With the complexity of handling the huge amount of metered data in a smart grid context as well as the lower temporal resolutions of the smart meters that is currently used, new and optimized monitoring models in distribution grids is essential for its economic and secured operation. Some of the published works had reported about generic guidelines meter allocations in traditional distribution networks wherein the meters are placed at specific locations of the grid like substations, feeders or at the distributed generation/critical load side, but not located optimally. This work proposed optimal power meter allocation method at strategic location of distribution grids combined with clustering techniques to enhance the grid observability. Further distribution state estimation is supplemented to determine online consumer load distribution in the network.

To exploit the flexibility from the active load and generation units in distribution grids and relieve any grid congestions, the DSOs has to apply proactive as well as reactively applied control schemes for the economic and reliable operation of the grid. Lot of published research have presented several control schemes and frameworks for control of active demand and generation. The two main types of control architectures listed are centralized and decentralized control schemes. The decentralized algorithms relieve local grid issues by reacting to the local grid conditions and information from the point of common coupling. This method is quite fast and perform well for eliminating local grid congestions. The centralized schemes have the information of the whole grid which it controls. It is a proactive and slower control, with a reduced scalability. A combination of both control frameworks applied sequentially is highly beneficial harnessing the benefits of both schemes. This is realized in this work for TVPP applications, where a hierarchical control is developed for interfacing the TVPP's flexibility with flexible market mechanisms while ensuring the secure operation of the grid.

7.3.2 Decentralised Short Term Load Forecasting

Owing to the transformation of modern electric distribution grids with the presence of a large number of intermittent generation and kW rated loads with diverse characteristics, the TVPP should ensure that its operation foresee grid problems and proactively react to them by applying suitable control mechanisms. Therefore, short-term forecast tools are essential in active distribution grids to avoid impending grid issues and supports commercial mechanisms to formulate suitable bids in the electricity markets. In this work package a novel sequential pattern forecasting methods is developed. The sequential pattern technique is a machine learning method that refer to data mining process. It closely relates to Markov processes, but the values used for sequential pattern mining are discrete. Fig. 1 shows an illustration of the sequential pattern forecasting method. It utilizes past sequences of states in order to forecast upcoming ones. The forecasted state would be "4" as it is more frequent than state "3".

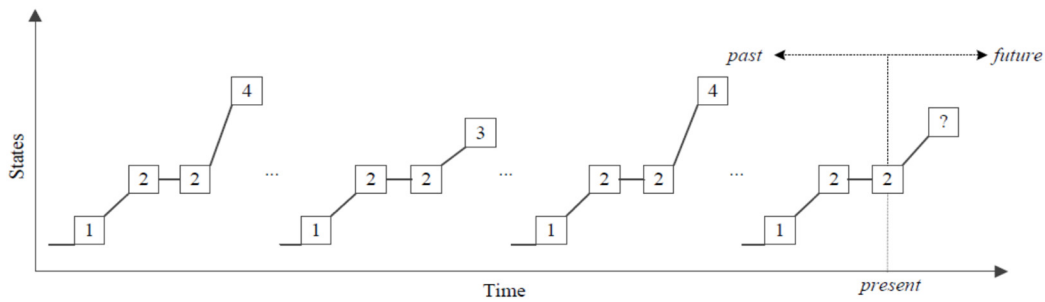

Figure 1 Example of sequential pattern forecasting

Fig 2. shows the application of the proposed method for hour-ahead forecasting of a consumer during a weekday in March. A comparison with ARIMA model based forecasting was also done to verify the performance of the new method. In Fig. 2, the sequential pattern forecasting performs exceptionally well, where the important sequences of patterns were recorded in the database and the demand profile are similar at subsequent time periods. The ARIMA model are incapable to predict the loading peaks as there was no periodicity in the demand profile apart from the night-time, thereby such established models are insufficient for decentralized forecasting. The periodicity and forecast performance of the method with respect to aggregation levels were analysed and it was verified that it has a good prediction potential at disaggregated electric demand levels.

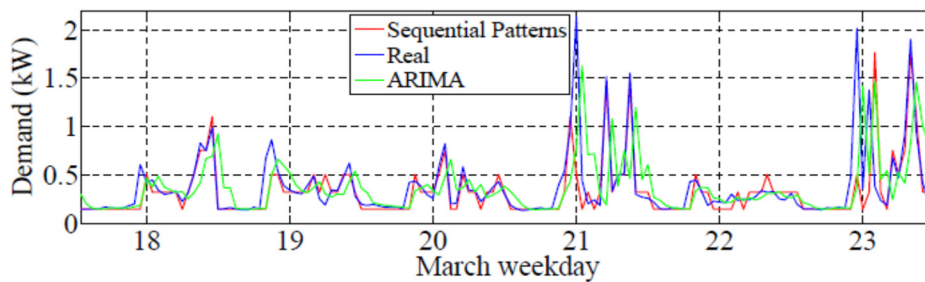

Figure 2 Performance of sequential pattern and ARIMA forecasting models at consumer level a) good sequential patterns performance

7.3.3 Estimation of Flexible Consumption

A novel stochastic NILM method is developed in this work to estimate flexible demand from an aggregated consumption profile of a consumer. This method offers superior advantages than conventional NILM techniques for load classification and identification where the former reduces significantly the need for managing huge amount of metered data, data communication and storage in smart grid systems. The method compares demand profiles of consumers with flexible loads with those of non-flexible consumers over a longer time period. The flexibility estimation algorithm performs a three step process, a) clustering – where non-flexible consumers are batched in groups, each groups is varied in terms of electrical behaviour, b) classification – the consumer with the flexible load is moved to that group where it has the highest similarities and c) estimation – In terms of probabilities, the flexible consumer profile is compared with similar non-flexible consumers and any load demand differences correspond to load intensive flexibility units.

To estimate the flexible demand of a consumer with heat pump, the flexible consumer profile is compared with a reference non-flexible group as given in Fig. 3. The most suitable probability density function (PDF) for the non-flexible consumer at each of the 24 time points are evaluated and compared it with the flexible demand profile. Fitting each of 24 PDFs results in Fig. 4a and Fig. 4.b which can be quantified using an area of probability (AP), various APs of the PDFs are given in Fig. 4.c. The flexible consumption is subtracted from a 90% AP, thereby an estimation of

the heat pump consumption is obtained as shown in Fig. 4d. The selection of AP is critical for the accuracy of flexibility estimation. Simulation results were conducted in this work to verify that APs of 80% or 90% gives fair results of estimating flexible consumption.

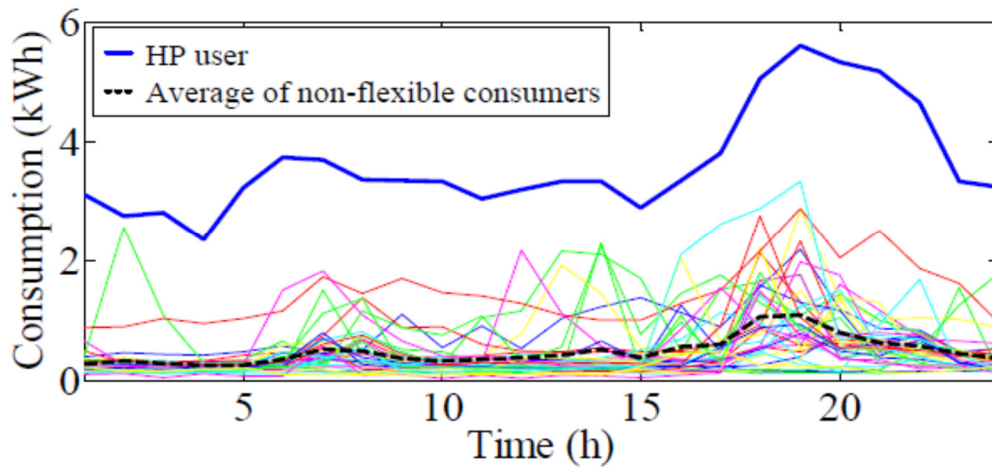

Figure 3 Demand profiles of flexible consumer and non-flexible

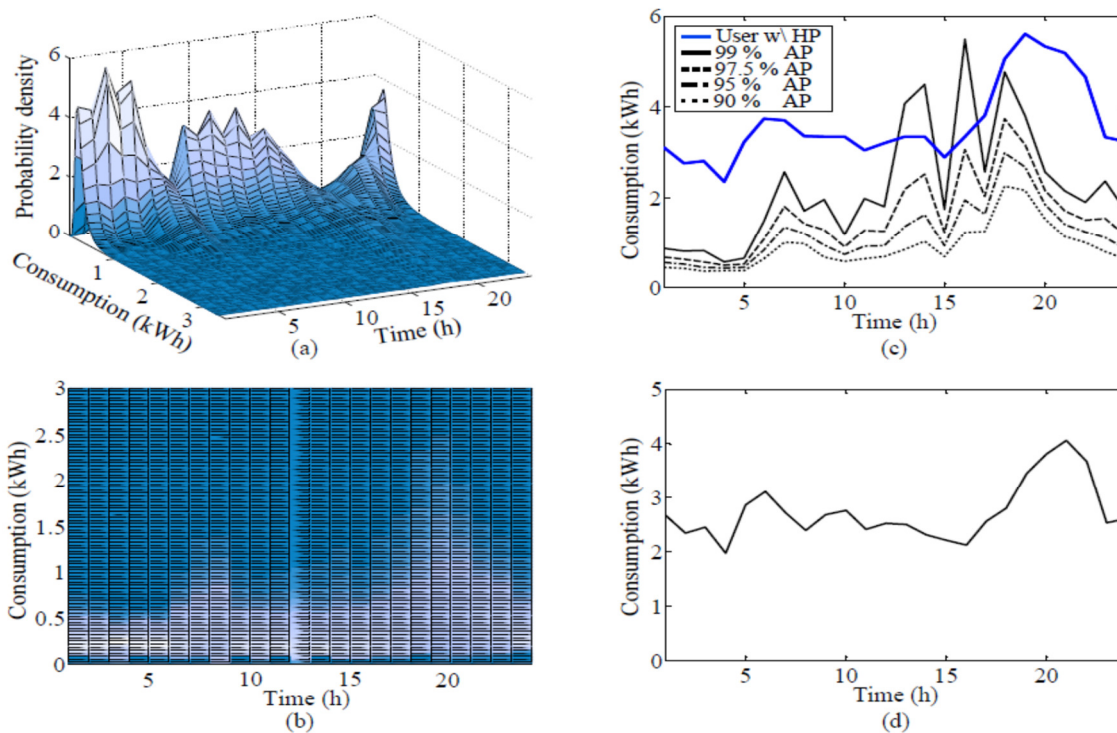

Figure 4 Estimation of flexible consumption from a heat pump for a day in February a) Fitted Probability density function (PDF), b) Top view of the fitted PDF, c) Area of Probability (AP) compared to flexible user and d) Flexible consumption for 90% AP

7.3.4 Load Monitoring in Low Voltage Distribution Systems

To achieve enhanced observability and predict operating conditions of the grid, with minimal amount of metering and data, offers economic and technical advantages to the DSO. To accomplish this, a hierarchical load monitoring scheme is developed in this work. The developed method uses binary integer linear programming for the optimization process to allocate power meters at

strategic locations in a low voltage distribution grid. This procedure considers the topology of the grid and the expected level of disaggregation to form optimal load monitoring sections. The objective of the process is to minimize loading index of the grid which is related to the forecasting performance and aggregation of the loads.

Based on this index, a hierarchical disaggregation of areas in the grid evolves which proves to perform meaningful predictive estimation. The load monitoring areas in Fig. 5 shows the results of the optimization routine, where power meters are placed at strategic locations with resultant nine load monitoring sections. The rest of grid area (hatched) is monitored by the transformer meter. Once the allocation of optimal meter is done, state estimation techniques is used to determine the load distribution. Online and pseudo measurements are used to conduct the state estimation. The estimation of consumer load profiles at enumerated nodes presented in Fig. 5 provides good approximations and shows the usefulness of the developed approach.

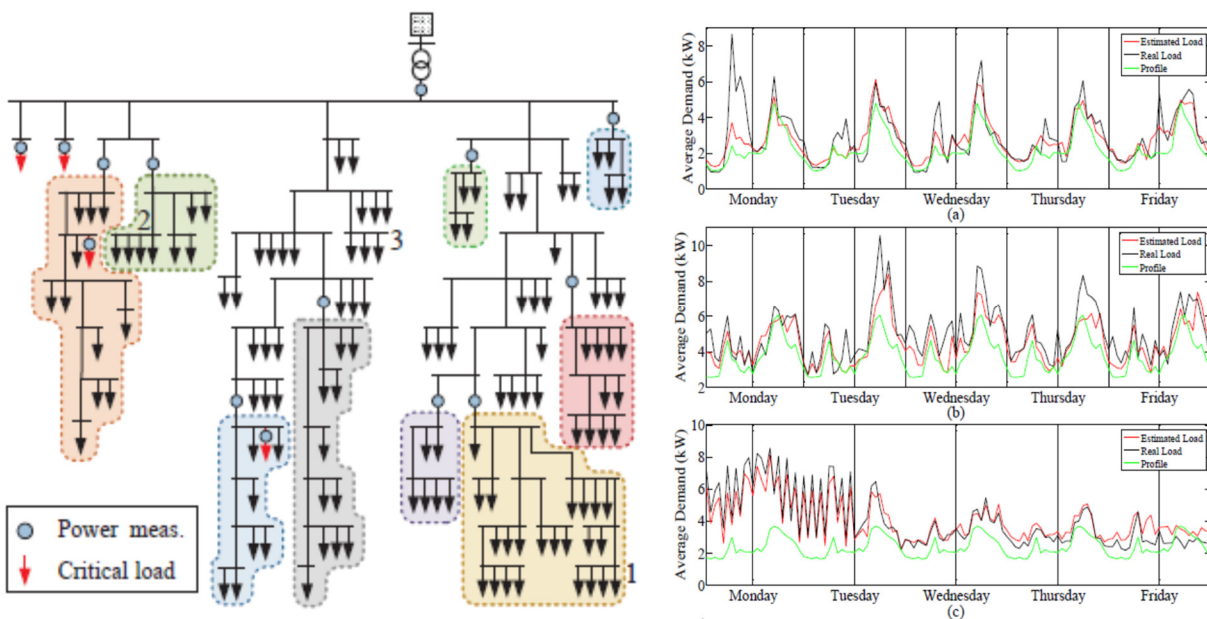

Figure 5 Grid load monitoring areas (left), estimation of load profiles at nodes 1, 2 & 3 respectively (right)An example of ADS query window

7.3.5 Congestion Management in Low Voltage Distribution Grids

The gradual introduction of active flexible load penetration is expected to challenge the capacity of distribution grids in the near future, and that could further result in congestions. To solve this issue, the DSO would like to extract and utilize the flexibility available in the grid rather than opting for costly and time-consuming grid reinforcements. However, this requires a coordinated and intelligent real-time control of the distribution grid assets, load and generation units that can adapt to the evolving flexible electricity markets structures and mechanisms. A two-stage hierarchical flexibility control framework is developed in this work where special attention is given to activate flexibility in a fair manner, thereby the consumers can widen their flexibility preferences irrespective of the robustness and their location in the grid. The proposed scheme utilizes the benefits of 'proactive' centralized control and 'reactive' decentralized control.

The central control operates on an hourly timeframe and proactively ensures hour-ahead balancing of the load distribution thereby relieving any impending grid congestions. This scheme utilizes an optimization routine to modify the estimated generation and demand at each node. This optimization procedure thus generates the flexibility amounts that can alleviate the grid bottlenecks.

This is further supplemented by a decentralized scheme that reactively regulate the load in real-time. It employs a power-voltage droop mechanism and the control enables intra-hour flexibility requirements that the centralized control cannot provide. This scheme is implemented at every node of the grid to continuously monitor and locally regulate the voltage if it deviates beyond an acceptable limit. Fig. 6 shows the distribution grid model used to test the two-stage flexibility control scheme and a flexibility limit of 20% is set at each node.

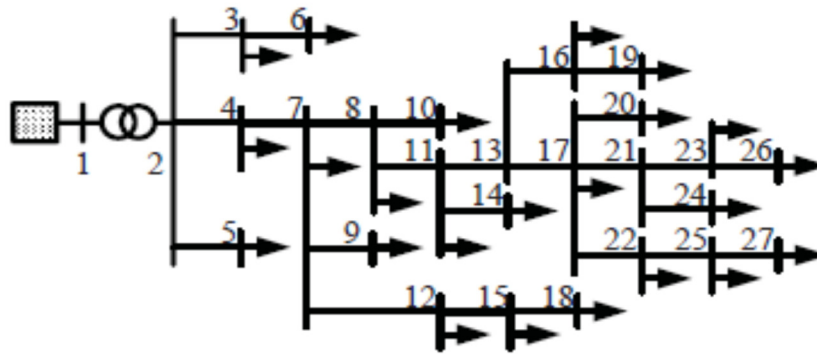

Figure 6 Test grid for demonstrating two-stage flexibility control

Fig. 7 shows the relevant grid parameters and flexibility for cases of active (green curves) and inactive (blue curves) centralized control. From Fig. 6a, the central control was able to maintain the voltage most of time within the predefined limits of 0.95p.u. However, there are few time-slots where the voltage values were not within the limits as indicated by grey spikes in the green area where flexibility was insufficient. In Fig. 7d it can be seen that the flexibility is utilised only for few hours in a day and also not to its available capacity. Fig. 8 presents the voltage and flexibility at node 14 and node 26 for cases where the decentralized control is active (green) as well as inactive (blue). The red horizontal lines are the voltage bands from the droop settings within which the flexibility is activated. In order to create load variations, random noise is added to the load profiles. There are no voltage violations at node 14 when the control is active, whereas at node 26, there are few instances of under-voltage violations evolving from insufficient flexibility of the customers at that node for those periods. Both the control schemes have to be used to achieve full flexibility in the network.

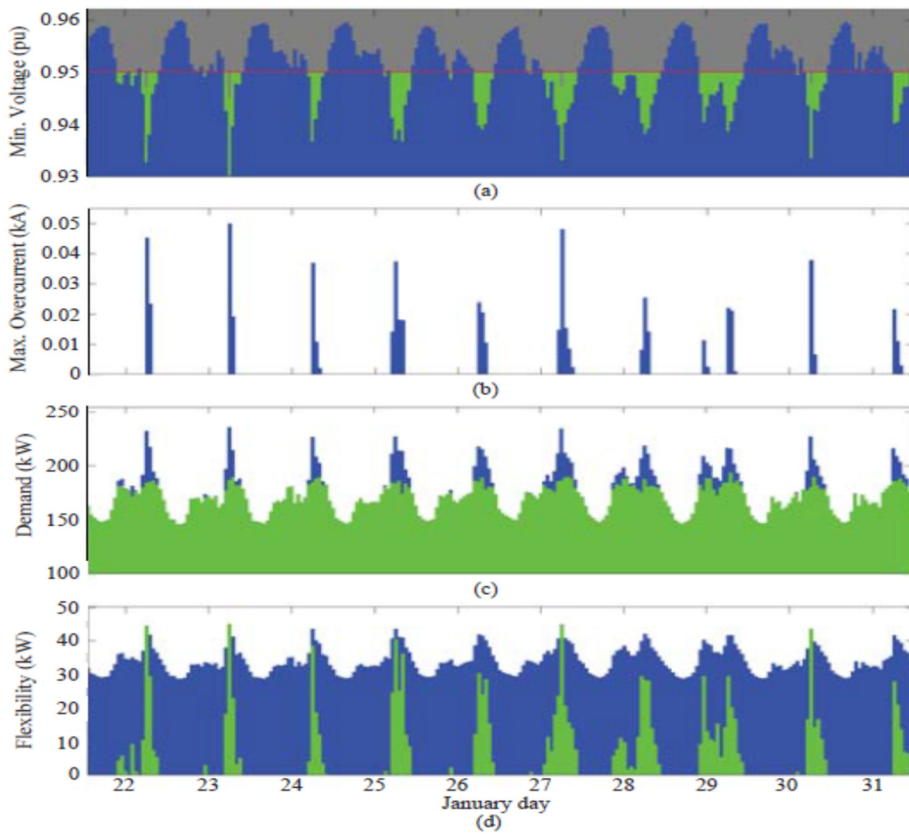

Figure 7 Results of centralized control a) minimum feeder voltage b) maximum feeder overcurrent, c) transformer load d) available (blue) versus activated flexibility (green)

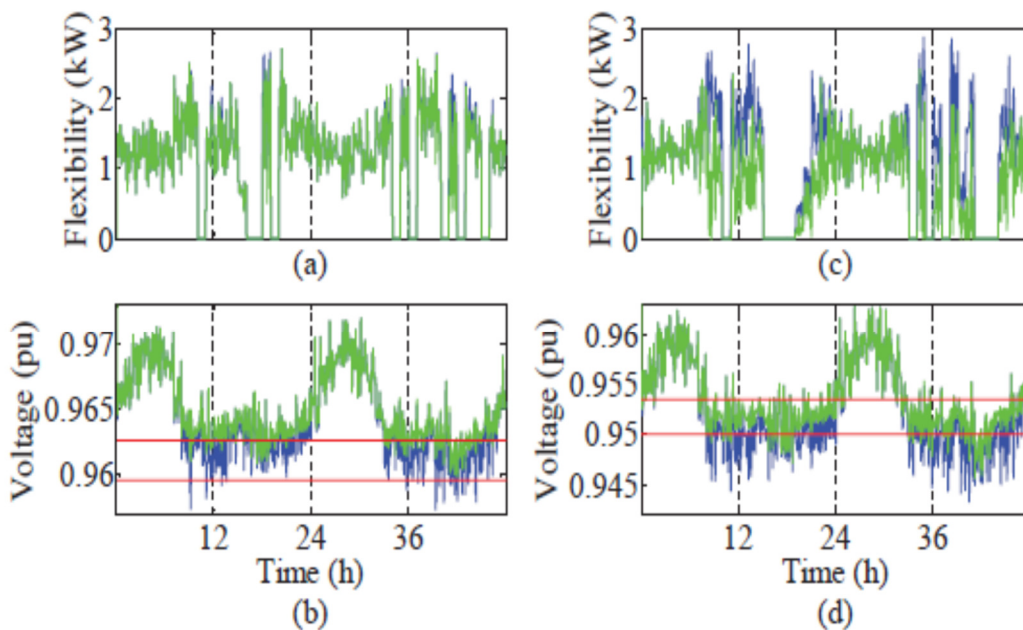

Figure 8 Results with (green) and without (blue) decentralized control – a) Flexibility of consumer at node 14 b) Voltage at node14 c) Flexibility of consumer at node 14 d) Voltage at node 26

7.3.6 Flexible Demand Management in Distribution Networks

As part of the TVPP demonstration in the TotalFlex project, a simplified optimal solution is proposed in this work package to determine the aggregated flexible demand that can be offered by large flexible loads like EVs (3.7kW) in a low voltage distribution grid with large penetration of local generation units like solar PV and wind turbines. The flexibility is calculated over a given time-horizon subjected to voltage ($\pm 5\%$), current and transformer capacity limits of the grid and it is managed in such a way that it could be shifted to next time-slot respecting the grid operational limits. In this way, the methods determine the appropriate time-slots where the large flexible loads like EVs can charge. A LV Danish grid connected with typical household consumers and other end-users like agriculture, industry and commercial are selected as the network model. The scenarios of different shares of 10kW wind and 6kW solar PV penetration in the grid are applied to the model. Steady-state simulation studies, both balanced and unbalanced scenarios are conducted on the selected study case.

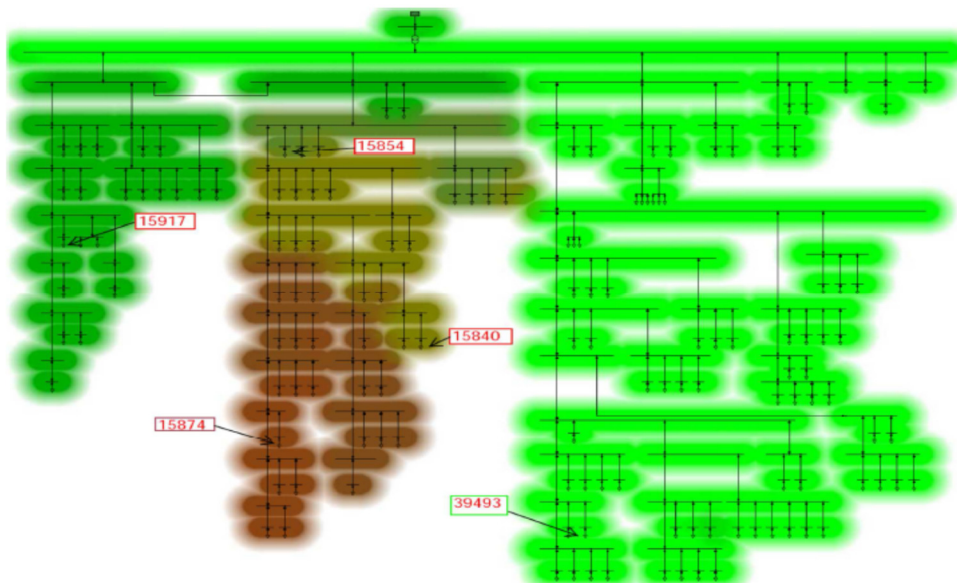

Figure 9 Test case low voltage distribution grid

Fig. 9 shows the single line diagram of the distribution network. The brown coloured zone in the diagram shows those nodes of the distribution network where grid bottlenecks in terms of voltage limit violations occur without application of the optimal routine to time-shift any flexible demand available in the network. Fig. 10 shows the aggregated flexibility, where the blue bars represent additional demand in the grid that cause voltage violations whereas the red bars are the shifted demand that is moved to the next likely time-slot where grid limits are satisfied. Fig. 11 shows the generation and demand in the grid, voltage profiles and loading of the transformer for the two cases, without and with optimal flexibility demand management simulated for a week in the month of April. By applying the shifting of flexible demand strategy, as indicated by the red bars, the voltage violations are completely alleviated as shown in the simulation results in Fig. 10 from the case of utilizing flexibility management in the grid. Based on the technical and market requirements, the shifting of such flexibility could be within intra-hour, intra-day or day-ahead, thereby facilitating a good case for the TVPP/CVPP to bid and schedule Flex-Offers in any electricity market and services. The conducted work didn't consider market transactions between players as well as with the market and also didn't consider the re-scheduling of flexibility based on market conditions and regulations. However, the technical benefits for using the network grid in a more optimal were discussed with the DSO, who has helped setting up the limits and really could see the benefits of this method.



Figure 10 Flexible demand that has to be shifted to avoid voltage issues (blue) and shifted flexible demand to the next possible time slot to avoid grid issues (red).

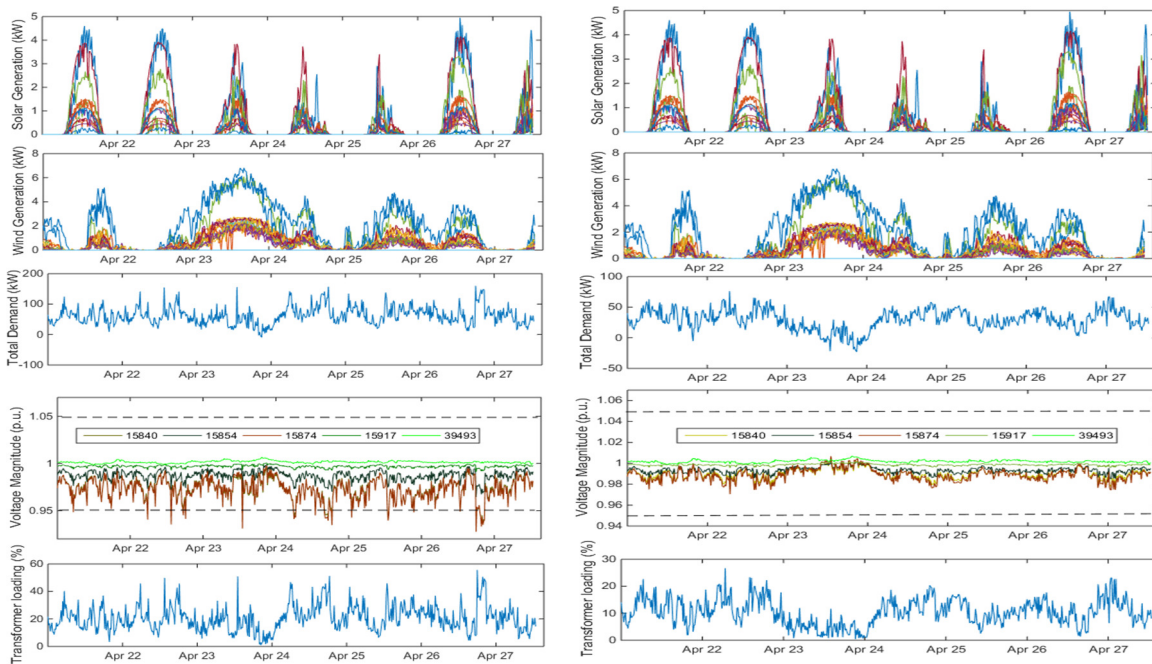

Figure 11 Case without (left) and with (right) flexible demand management a) solar PV production b) wind power production, c) total demand in the grid, d) voltage profile for selected nodes and e) transformer loading

7.4 Conclusions

The prime initiative for implementing smart grids from DSOs perspective are triggered from the capacity limitations in distribution grids resulting from the increasing penetration of distributed generation and sizeable flexible loads. The TVPP setup are expected to efficiently and economicaly manage and control the local grid flexibility, thereby improving the grid utilization factor and delaying expensive grid reinforcements in distribution grids. However, in order to modernise the existing grids and its practices to realise the smart grid framework, some of the major shortcomings in terms of forecasting, flexibility estimation and control, and online monitoring setups are to be specifically addressed in distribution grids. In this work package, appropriate models and methodologies are developed to overcome these challenges, leading to the technical implementation of the TVPP.

For the TVPP to prevent grid limit violations, novel forecasting techniques are necessary for preventive and corrective flexibility control in distribution grids. In this work, new short-term load forecasting was developed based on a non-parametric machine learning technique. The method is adaptable and automatic thus compatible with the TVPP requirements. These shorter load prediction methods help the DSOs to apply appropriate control methods in active grids thus avoiding

imminent grid issues. Such short-term load forecasting is also useful for commercial players for formulating more accurate and effective demand bids in the electricity markets.

To apply proactive control, the TVPP needs a good knowledge of the flexible demand in the electricity network. Due to the limitations in the management of huge metered data, limitation of communication, and data storage, flexibility in local grids needs to be estimated. A novel NILM technique is developed in this work that overcomes the limitations of the conventional NILM method and sampling frequencies of smart meter data. The key advantage of this method is for the DSOs when they can manage potential bottlenecks in their grids when there is limited information and data on flexibility from the underlying grid.

To supplement predictive control of distribution grids, online load monitoring in local distribution grids is essential. The existing metering infrastructure and systems doesn't facilitate this requirement. An online load monitoring scheme with optimal calculation of the number of power meters is developed in this work. This scheme will help the DSOs in eliminating issues with data management. It could be applied for situations where smart metering is unavailable and for those smart systems where online monitoring and situational awareness has to be improved. Overall, it improves the observability of the network and the load distribution, thus supporting DSOs in their planning and operational processes.

To implement intelligent strategies of flexibility control in the smart grid framework, a hierarchical control scheme encapsulating a coordinated centralized and decentralized control is developed in this work. The role of the centralized scheme is to implement a proactive control and schedule flexibility requests to alleviate grid limit violations. As a faster control, the decentralized schemes employ reactive control for real-time local voltage variations in the grid. The two schemes are coordinated such that flexibility is distributed in a fair manner among all consumers. This control architecture enables DSOs to enhance the asset utilisation and grid hosting capacity, and implement efficient demand side management strategies thereby paving the way for an active and smarter grid. This will also promote the active participation of market players and the prosumers in different demand response techniques and system services with which they can benefit economically.

Further, a simplified optimal demand flexibility management strategy is developed in this work package to demonstrate the quantification of aggregated flexible demand and its demand response control to eliminate grid bottlenecks in a low voltage distribution grid integrated with local distributed generation and demand response resource like EVs. This strategy helps both the DSOs and the commercial players with temporal and spatial information about the available flexibility for constructive bidding, scheduling and utilizing of flexible demand more techno-economically in active distribution grids. As a final contribution of this work, the interaction of the TVPP with the wholesale and retail markets were analysed and its suitability with the contemporary and flexible electricity markets were established.

Some of the future work that could be investigated further are:

- To improve the accuracy of the proposed forecasting technique, daily periodicity at aggregated levels could be added to the sequential pattern algorithm. It would be interesting to develop hybrid forecasting techniques combining the proposed method and already established techniques.
- The estimation of flexibility from other demand response resources like electric vehicles, electric water heaters, and energy storages in conjunction with small and large distributed generation units like solar PVs would be interesting. Flexibility assessment of large consumers like supermarkets, buildings etc. are also interesting topic to be explored.
- The online monitoring and metering allocation scheme can be extended to grid with loop and meshed configurations, especially in medium voltage distribution grids. Also, the impact of

phase imbalance and local generation units on the proposed scheme could be investigated further.

- It would be interesting to incorporate technical limitations and characteristics of flexible demand units as part of the hierarchical control scheme.
- For the issue concerning Flexible Demand Management in Distribution Networks it could also be interesting to see if the flexibility could be moved not only according to the technical limits but also due to different price signals.

7.5 References

- [1] K. Kouzelis, Load and Flexibility Models for Distribution Grid Management, Ph.D. thesis, Aalborg University 2015
- [2] K. Kouzelis, Z. H. Tan, B. Bak Jensen, J. R. Pillai, and E. Ritchie, "Estimation of Residential Heat Pump Consumption for Flexibility Market Applications," *IEEE Trans. Smart Grid*, vol. 6, no. 4, pp. 1852-1864, Jul. 2015
- [3] B. P. Bhattarai, K. Kouzelis, I. Diaz de Cerio Mendaza, B. Bak Jensen, and J. R. Pillai, "Smart Grid Constraint Violation Management for Balancing and Regulating Purposes," *IEEE Trans. Industrial Informatics.*, submitted
- [4] K. Kouzelis, I. Diaz de Cerio Mendaza, and B. Bak Jensen, "Probabilistic Quantification of Potentially Flexible Residential Demand," in *Proc. IEEE PES General Meeting, National Harbour, MD, 2014*
- [5] K. Kouzelis, B. Bak Jensen, P. Mahat, and J. R. Pillai, "A Simplified Short Term Load Forecasting Method Based on Sequential Patterns," in *Proc. IEEE PES Innovative Smart Grid Technologies Europe, Istanbul, 2014*
- [6] K. Kouzelis, B. Bak Jensen, and J. R. Pillai, "The Geographical Aspect of Flexibility in Distribution Grids," in *Proc. IEEE PES Innovative Smart Grid Technologies, Washington, DC, 2015*
- [7] K. Kouzelis, I. Diaz de Cerio Mendaza, B. Bak Jensen, J. R. Pillai, and K. Katsavounis, "Enhancing the Observability of Traditional Distribution Grids by Strategic Meter Allocation," in *Proc. IEEE PES PowerTech, Eindhoven, 2015*
- [8] K. Kouzelis, I. Diaz de Cerio Mendaza, B. Bak Jensen, J. R. Pillai, and B. P. Bhattarai, "Allocation of Power Meters for Online Load Distribution Estimation in Smart Grids," in *Proc. IEEE PES Innovative Smart Grid Technologies Asia, Bangkok, 2015*
- [9] P. Pavani, B. Bak Jensen and J. R. Pillai, "Impact of Demand Side Management in Active Distribution Networks," in *Proc. IEEE PES GM 2017, Submitted*

8 WP6 – Development of Commercial VPP (CVPP)

This work package is about the CVPP, which is an IT tool primarily for Aggregator and BRP. First is described the main work tasks for Aggregator and BRP, then a description of the IT tool which is developed and presentations of some of the main GUIs.

8.1 Aggregator

The most important typical work tasks in chronological order for the Aggregator can be summarized as:

- Setting up a contract with the Prosumer, the owner of the Flexible Resource
- Setting up a measurement and control route to the Flexible Resource
- Setting up a contract with a BRP regarding balancing the Flexible Resource
- Securing electricity to the Flexible Resource
- Setting up a link to an available Market Place
- Creation of Flex-Offers depending on contract with the Prosumer
- Aggregation of Flex-Offers
- Pricing of Flex-Offers
- Submission of appropriate Flex-Offers to the Market Place
- Disaggregation of Flex-Offers
- Submission of plans to BRP
- Purchase of Energy
- Submission of operation schedules for the Flexible Resources
- Settlement of balancing cost with BRP
- Settlement with the Prosumer

Depending on the Market Place is operating day-ahead or intra-day some of the above steps might be interchanged. A more detailed description of the steps in the Market Place is presented in the demonstration chapter. Also, considerations regarding contract settlement between the actors is presented in the demonstration chapter.

8.2 BRP

The most important typical work tasks for the BRP can be summarized as:

- Being a balancing responsible for the Aggregator
- Setting up a contract with a BRP regarding balancing the Flexible Resource
- Creation of Flex-Offers depending on the market opportunities with flexibility and the BRP's internal need
- Pricing of Flex-Offers
- Submission of appropriate Flex-Offers to the Market Place
- Settlement with the Prosumer

Depending on the Market Place is operating day-ahead or intra-day some of the above steps might be interchanged.

8.3 CVPP functionality

Based on the above work tasks the CVPP IT tool is developed. It was decided to include the following functionality inside the CVPP:

- Visualisation and monitoring of actual and historical measurements on individual and aggre-

- gated device level including alarm functionalities
- Flexibility analysis with Flex-Offer display
- Aggregation techniques

There have not been made a GUI for the contract and settlement activities, however they are more detailed described in the demonstration chapter.

An example of the GUI for visualisation device level looks like:

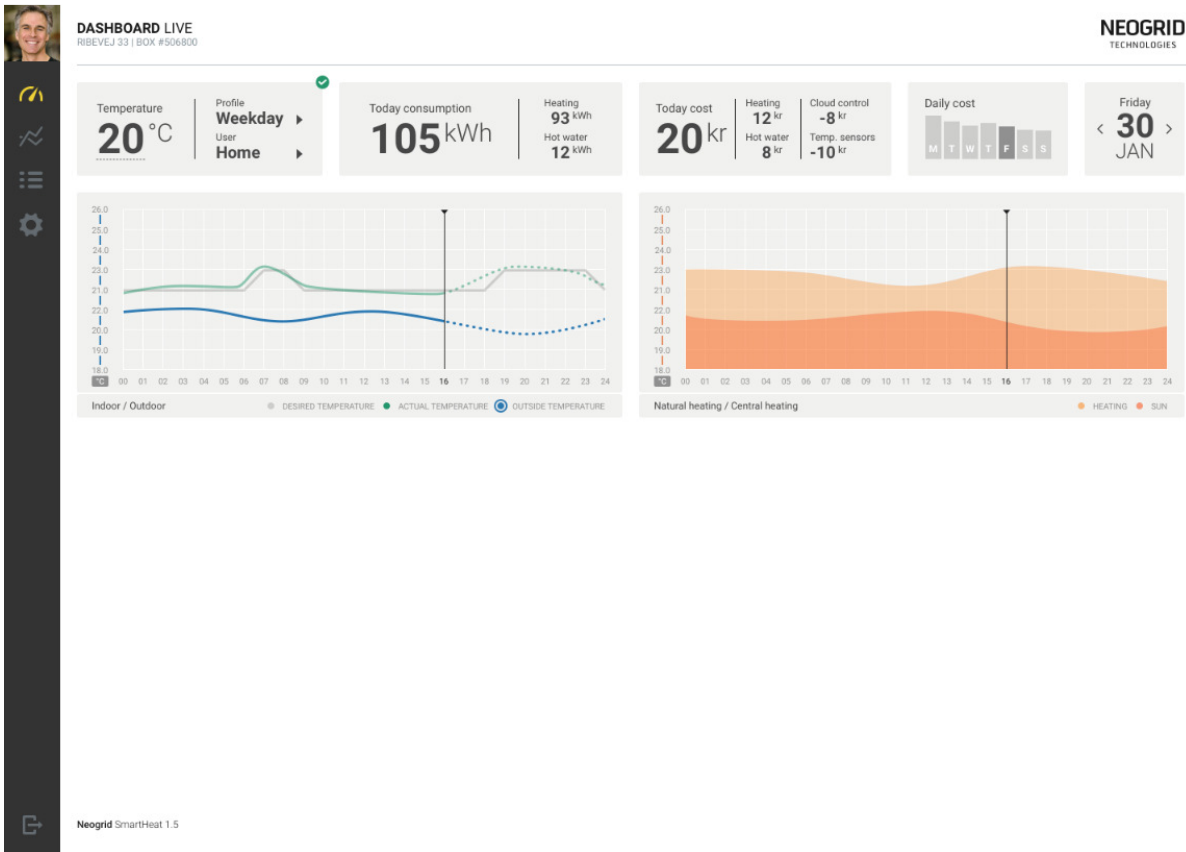

Figure 12 An example of a GUI showing actual data regarding heat pump operation

Another example of a GUI monitoring a pool of devices looks like:

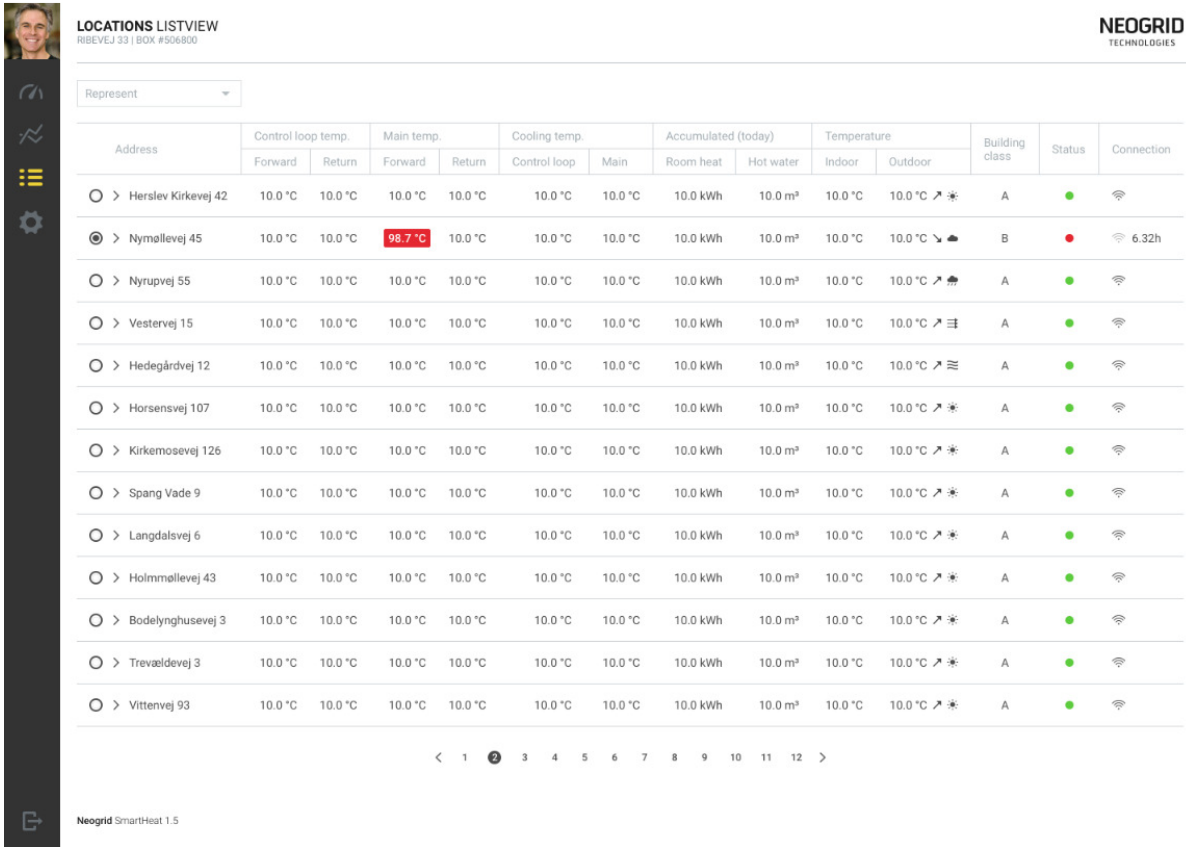

Figure 13 An example of a GUI showing actual status of a pool of heat pumps

To represent the flexibility of a Flex-Offer various types of plots can be used. For a heat pump it could look like:

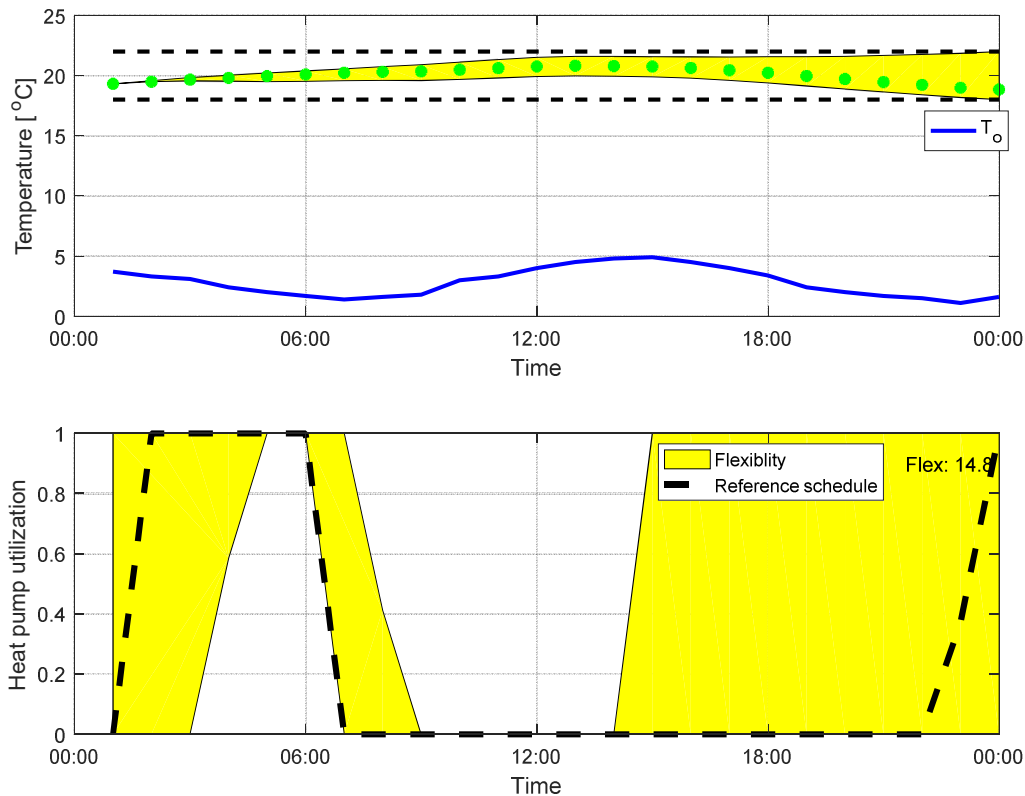

Figure 14 24h Flexibility development for a heat pump inside a typical modelled house

In the above figure is shown a 24h flexibility development for a heat pump. In the top figure, outdoor temperature (blue line) is shown together with comfort range inside a house (black dashed line). Also, is shown inside the yellow area possible indoor temperatures that might take place depending on the heat pump operation. The green dotted line is temperature which will take place if the reference schedule in the lower figure is followed.

In the lower plot above is shown inside the yellow area the allowed heat pump operations within the next 24 hours, that will secure the temperature of the house to be within its comfort range. The black dashed line is the reference operation. Also, is shown a flexibility value of 14.8 kWh, which represents the maximum accumulated flexibility across the 24 hours.

Another important part of the CVPP is to support the Flex-Offer aggregation process. This includes aggregation and disaggregation within the following dimensions:

- Geographical
- Type
- Grid area
- Electricity Market area
- Hierarchical

The capability to operate within the above dimensions is very important because it can create more useful macro Flex-Offers that fulfils potential buyers interest more. Maybe an Aggregator is specialised within a specific type of device and therefore aggregation within the same type or hierarchical aggregation is very useful. In chapter 4 is shown some GUI plots with the developed aggregation and disaggregation capabilities.

9 WP7 – Design and development of a Market Place

9.1 Introduction

The work developed under WP7 had as point of departure the technical definition of a Flex-Offer, described in the earlier MIRABEL project. The main question addressed by WP7 was creating a marketplace for flexibility, as described by a Flex-Offer. To this end, WP7 developed all necessary steps to make the Flex-Offer (or more accurately, the flexibility it describes and contains) a tradeable commodity that agents with an interest in power system flexibility would be able to value and exchange, such that the interaction of buyers and sellers in the marketplace would lead to discovering the price for flexibility.

From a methodological perspective, the work used *technical* input (from earlier work and other WPs) while relying on *economics* to deliver the research output. The deliverables of the WP were based on well-established areas of the economic literature, to which they also contributed. These areas include Industrial Organization, Contract Theory, Market Design, Combinatorial Auctions but always with a specific reference to Energy Economics in general, and Power System Economics in particular. At the same time, all the research output produced is *applicable* to the general question investigated by TotalFlex, and contributes to the current debate of power system flexibility.

However, it is important to note that there was not a one-to-one relationship between the deliverables outlined in the original TotalFlex proposal and the articles, PhD thesis chapters produced in WP7. Instead, the deliverables are scattered throughout several papers that respond to each and every deliverable. In what follows, we refer to the deliverables and within each deliverable; we refer to the specific papers where the questions are addressed.

9.2 Deliverable 1: State of the art analysis – status of today, what has been done

While the main advantage of the Flex-Offer is that it is able to describe the flexibility of any supply-side or demand-side resource, in an aggregated or disaggregated fashion, it is far from the only way in which flexibility is defined and traded in the present. With this in mind, papers [1] and [2] reviewed the state of the art in relation to existing business models for power system flexibility, together with a comparison of existing power system flexibility products.

9.3 Deliverable 2: Analysis of the Flex-Offer as a commodity

Another important question *before* the market design stage (i.e. how to clear the marketplace for flexibility) was the question of what was to be traded in the market. In this regard, the most general vision of flexibility as a commodity is contained in [2]. According to this vision, *any* fruitful definition of power system flexibility for market and product design purposes must account for the multi-attribute nature of power system flexibility, the imperfect complementarity among its elements, and the heterogeneity of the flexibility product space.

For the specific problem addressed by TotalFlex, it was convenient to define *Delta Energy* as the traded product in the marketplace for flexibility. This perspective is defined in [3] as “the available energy contained in a Flex-Offer, relative to a baseline assignment, determined by its issuer”. Not only was the Delta Energy definition adequate from a technical perspective, as it reconciles issues in aggregation and Flex-Offer generation that concerned other WPs, but it is also a good perspective to which the Product-Mix Exchanges (PMEs), specifically designed to clear the flexibility marketplace suits well.

9.4 Deliverable 3: Analysis of pricing principles

As mentioned in the introduction, it was the central goal of WP7 to create a marketplace for flexibility. Accordingly, it is the match of supply and demand for flexibility what defines the *market price* of the flexibility products, and the details of this approach are studied in detail in [3]. However, the market price is the reflection of the price at which market participants (such as aggregators and DSOs) have agreed to obtain flexibility from small-scale suppliers of flexibility, such as households, which may not be able to sell their flexibility directly in the marketplace. WP7 has investigated two alternative approaches for this problem.

In [4] the focus was on demand-side flexibility with a focus on incentive-based contracts, as opposed to price-based demand response. The analysis encompasses incentive-based contracts, such as direct load control programs, interruptible supply contracts, and dynamic load capping contracts. With a short term perspective, the analysis shows that an aggregator and a household gain from trading flexibility as a consequence of the possibility that the first has to manage price risk and the opportunity that the second has to reduce its electricity bill. With a longer-term perspective, the paper concludes that both parties must trade for a sufficiently long period of time in order to cover the investment cost associated with a transaction cost reducing technology, such as the one associated to trading flexibility mediated by Flex-Offers.

In [5] the authors took a more general approach to the problem that a utility company, a DSO, an aggregator or even a TSO may have when procuring flexibility from flexibility suppliers. According to this perspective, the buyer of flexibility is asymmetrically informed with respect to the cost of flexibility that suppliers have. Moreover, the paper makes the claim that – in accordance with [2] – both the cost and utility have multiple attributes whose individual contribution cannot be entirely disentangled. Considering the economic attributes of flexibility, which had not been analysed so far, the proposed model is “much more than a theoretical curiosity and have implications of practical relevance for energy policy makers in general and system operators in particular”. Moreover, the study explains in detail how to apply the framework to *actually* design optimal contracts that incentivize the provision of power system flexibility.

9.5 Deliverable 4: Design of a state-of-the-art electronic marketplace

Once the question of *what is to be traded* was elucidated, the actual marketplace design was the next step to follow. This was achieved in [3] where PMEs, which are, “double, multi-unit combinatorial auctions in which buyers and sellers report substitutable preferences over bundles of goods” were introduced. Specifically, section 6 of [3] goes into the details of how to clear a Delta Energy Market and explains how quantity flexibility and time shifting products are traded. A remarkable feature of the models explained in this paper –which can be considered as the inner economic core of the marketplace – is that its computational cost is very low. A simple Linear Programming –without a single integer constraint – is enough to clear the flexibility marketplace.

9.6 Deliverable 5: Test and demonstration of the marketplace in terms of:

The input from WP7 into the marketplace demonstration was through [3] but the leading role in this part was taken by WP8.

9.7 References

[1] Boscán, L. and Poudineh, R. (2016) “Business Models for Power System Flexibility: New actors, New roles, New rules”. Chapter 19 in “The Future of Utilities: Utilities of the Future”, Ferei-

doon P. Sioshansi (ed.), 466 pp. ISBN: 978-0-12-804249-6. Available on-line at:

<http://dx.doi.org/10.1016/B978-0-12-804249-6.00019-1>

[2] Boscán, L. "Power System Flexibility: A Product design perspective". Chapter 2 in "Essays on the Design of Contracts and Markets for Power System Flexibility". PhD thesis, Economics Department. PhD Series, volume 37.2016. Copenhagen Business School (CBS), 337 pp. ISBN: 978-87-93483-38-5. Available online at: <http://hdl.handle.net/10398/9367>

[3] Boscán, L. "Product-Mix Exchanges, Efficiency and Power System Flexibility". Chapter 5 in "Essays on the Design of Contracts and Markets for Power System Flexibility". PhD thesis, Economics Department. PhD Series, volume 37.2016. Copenhagen Business School (CBS), 337 pp. ISBN: 978-87-93483-38-5. Available online at: <http://hdl.handle.net/10398/9367>

[4] Bogetoft, P., Boscán, L and Møllgaard, P. "Trading Demand-Side Flexibility in Power Markets". Chapter 3 in "Essays on the Design of Contracts and Markets for Power System Flexibility". PhD thesis, Economics Department. PhD Series, volume 37.2016. Copenhagen Business School (CBS), 337 pp. ISBN: 978-87-93483-38-5. Available online at: <http://hdl.handle.net/10398/9367>

[5] Boscán, L. and Poudineh, R. (2016) "Flexibility-Enabling Contracts in Electricity Markets". Oxford Institute for Energy Studies Paper: EL 21. ISBN 978-1-78467-063-4. Available online at: <https://qoo.gl/1192ft>

9.8 Abstracts of papers produced in WP7

Product Mix Exchanges, Efficiency and Power System Flexibility: This paper develops extensions to the Product-Mix Auction (PMA), which are generalized under the name of Product-Mix Exchanges (PMEs): double, multi-unit combinatorial auctions in which buyers and sellers report substitutable preferences over bundles of goods. A key feature of PMEs is that participants can buy and sell without having a fixed role as buyers or sellers, effectively swapping over the two sides of the market. Furthermore, PMEs are applicable when goods are divisible or indivisible and strong substitute or ordinary substitute preferences are imposed on market participants. The main contributions of the paper are, first, applying existing tropical geometric techniques to the analysis of substitutable preferences. Second, proposing a linear programming approach to identify if a set of valuations have equilibrium with indivisibility. Third, analysing the conditions under which Vickrey-Clarke-Groves (VCG) payments can support the efficient allocation of a PME. Finally, I apply the PME framework to the design of a marketplace for power system flexibility, namely the Delta Energy Market in which quantity flexibility and time shifting products are traded. JEL codes: D44, D47, D82, C61, C65

Flexibility-Enabling Contracts in Electricity Markets: this paper asks the fundamental question of how should the provision of power system flexibility, a multi-dimensional commodity whose elements are non-separable and imperfectly substitutable, be incentivised? We model the procurement of flexibility services from emerging small resources through bilateral contracts in a multidimensional adverse selection setting. Taking a normative perspective and show how efficient contracts for flexibility services can be designed given its peculiarity as an economic commodity. Through a simulation analysis we elucidate the applicability of the proposed model and demonstrate the way it can be utilised in, for example, a thermostat-based demand response programme. JEL codes: D82, D86, L14, L94

Trading Demand-Side Flexibility in Power Markets: This paper focuses on the particular kind of flexibility that can be harnessed from demand-side resources, as mediated by a technological solution, i.e. the Smart Grid, which reduces transaction costs to a negligible level. In contrast to price-based demand response, the bilateral baseline model of flexibility trading of this paper models incentive-based contracts in which consumers are remunerated for their willingness to modify demand. With a Nash bargaining approach, the baseline model of this paper shows that it is possible for an aggregator and a consumer to gain from trading flexibility in single-shot trans-

actions. Taking a long-term perspective, the model shows that agents must be able to trade for a sufficiently long period to cover investment costs. Furthermore, the way in which these are shared determines how favourable the conditions are for consumers. Relative to the case in which costs are symmetrically shared, when the consumer faces a relatively higher cost than the aggregator, the consumer is able to obtain a better deal for its flexibility. Such a finding relates to the possibility of a network effect in the aggregation business, which requires some degree of scale economies in the flexibility-enabling technology. By extension, this result speaks about the possibility of introducing competition among aggregators in a potential market for flexibility. JEL codes: L94, C78, L14

Business Models for Power System Flexibility: New Actors, New Roles, New Rules: This chapter identifies and analyses existing business models that enable power system flexibility, a requirement that is not actually novel but is becoming critical for the successful integration of renewables. We find that technological innovation - with the Smart Grid as catalyst - is essential to enable the flexibility of existing resources in the power system and note that many of these developments are already taking place. We claim that, as a result, an entirely different electricity industry is emerging: one in which new activities are being added to the traditional supply chain, contesting the status quo. Incumbents, who rely on traditional, large scale industrial assets are beginning to compete with entrants who depend on a non-traditional, knowledge-based mode of operation. JEL code: L94

Power System Flexibility: A product design perspective: By way of concrete examples from the short-term operation of the Danish and Californian power systems, this paper illustrates the need for flexibility when integrating renewables and reviews the existing literature on the topic. Motivated by the technical characteristics of power system flexibility, the paper then presents two simple, yet relevant contributions of normative nature. The first of these consists in three economic postulates that should guide the economic modelling of flexibility. Specifically, the paper argues that flexibility has multiple attributes, which are imperfectly substitutable and that flexibility is an inherently heterogeneous commodity. The second contribution is a set of desirable properties that any product design should have to actually enable flexibility, namely simplicity, measurability and relevance. The chapter ends with a review of existing product designs for power system flexibility. JEL codes: L94, D47

9.9 Presentations by PhD student Luis Boscan from WP7

Product-Mix Exchanges, Efficiency and Power System Flexibility:

Workshop: *New Trends in Mechanism Design III*. Copenhagen, 17-19 August 2015, Denmark. Organized by the Centre for Electronic Markets (CFEM).

Conference on Economic Design 2015. Istanbul, 1-4 July 2015, Turkey. Organized by the Society for Economic Design.

Flexibility-Enabling Contracts in Electricity Markets:

38th IAEE International Conference. Antalya, 25-27 May 2015, Turkey. Organized by the International Association for Energy Economics (IAEE).

Trading demand-side Flexibility in Power Markets:

Young Energy Economists and Engineers Seminar. Leuven, 27-28 November 2014, Belgium. Organized by the Young Energy Economists and Engineers Seminar (YEEES) network.

Danish Graduate Program in Economics Workshop 2014. Nyborg, 13-14 November 2014, Denmark. Organized by the Danish Graduate Program in Economics (DGPE).

14th IAEE European Energy Conference. Rome, 28-31 October, Italy. Organized by the International Association for Energy Economics (IAEE).

10 WP8 – Demonstration

In the TotalFlex project most of the functionality have been implemented and demonstrated live at several occasions.

10.1 Key actors in a simple Market Place

A simple scenario with key actors are defined. Those will be the main actors in the demonstration and their connections are shown here:

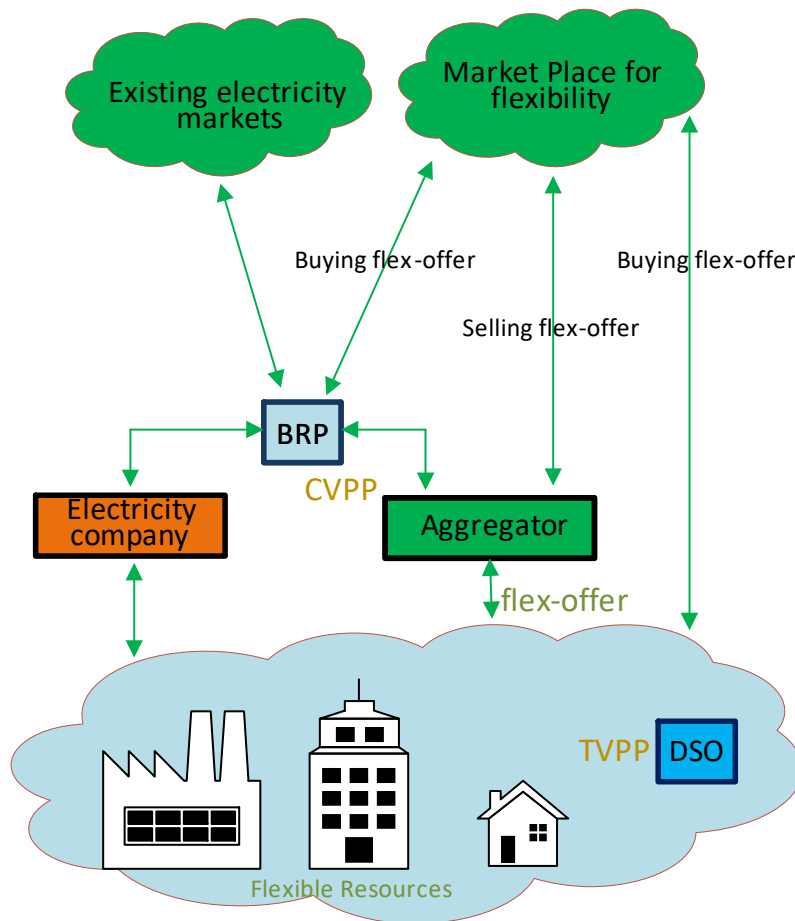

Figure 1: TotalFlex Main actor and their connection

The general idea with the *Market Place* for flexibility is to offer the owner of the flexibility, here the seller, the best business opportunity. As the opportunity changes over time among various buyers a Market Place is developed to set the best actual price, seen from the sellers point of view, for the flexibility.

The flexibility comes from connected Flexible Resources, i.e. various electrical devices in factories, office building, residential houses etc. The Flexible resources are separated from the conventional non-flexible consumption. This means they are also metered and settled separately. In the TotalFlex setup, the Flexible Resources are connected to an Aggregator, who also has a role as Electricity Company. The Aggregator has an agreement with a BRP to purchase its energy and

cover imbalances. This is in line with the ideas in the standardization work at Market model 2.0⁸ driven by Energinet.dk and coordinated within the Energy Union activities inside EU.

The *Market Place* for flexibility works in parallel to existing energy markets, so *no energy is traded*. Only the actual positioning of consumption or production in time described as *deviation in energy consumption* relative to a baseline is sold. Input to the Market Place are Flex-Offers with price information coming from both buyers and sellers.

On the buying side, the interest comes from DSOs and BRPs. The main reasons for the two buyers' interest in flexibility is for the DSO to mitigate bottlenecks and for the BRP to reduce internal imbalances and take advantage of the time varying prices in existing energy markets.

10.2 Functionality to be demonstrated

The Market Place coexists and supports the existing phases of the energy markets today, like:

- Long term agreement
- Day ahead
- Intra-day
- Intra-hour

In TotalFlex the main focus has been on how the Market Place works together with day ahead market activities (spot price) and intraday market activities (regulating power). The activities are shown in the following sequence diagrams, where Flex-Offers are abbreviated to *FO*.

⁸ Energinet: Market model 2.0 at Energinet.dk,
<http://energinet.dk/...markedsmodel/Sider/default.aspx>

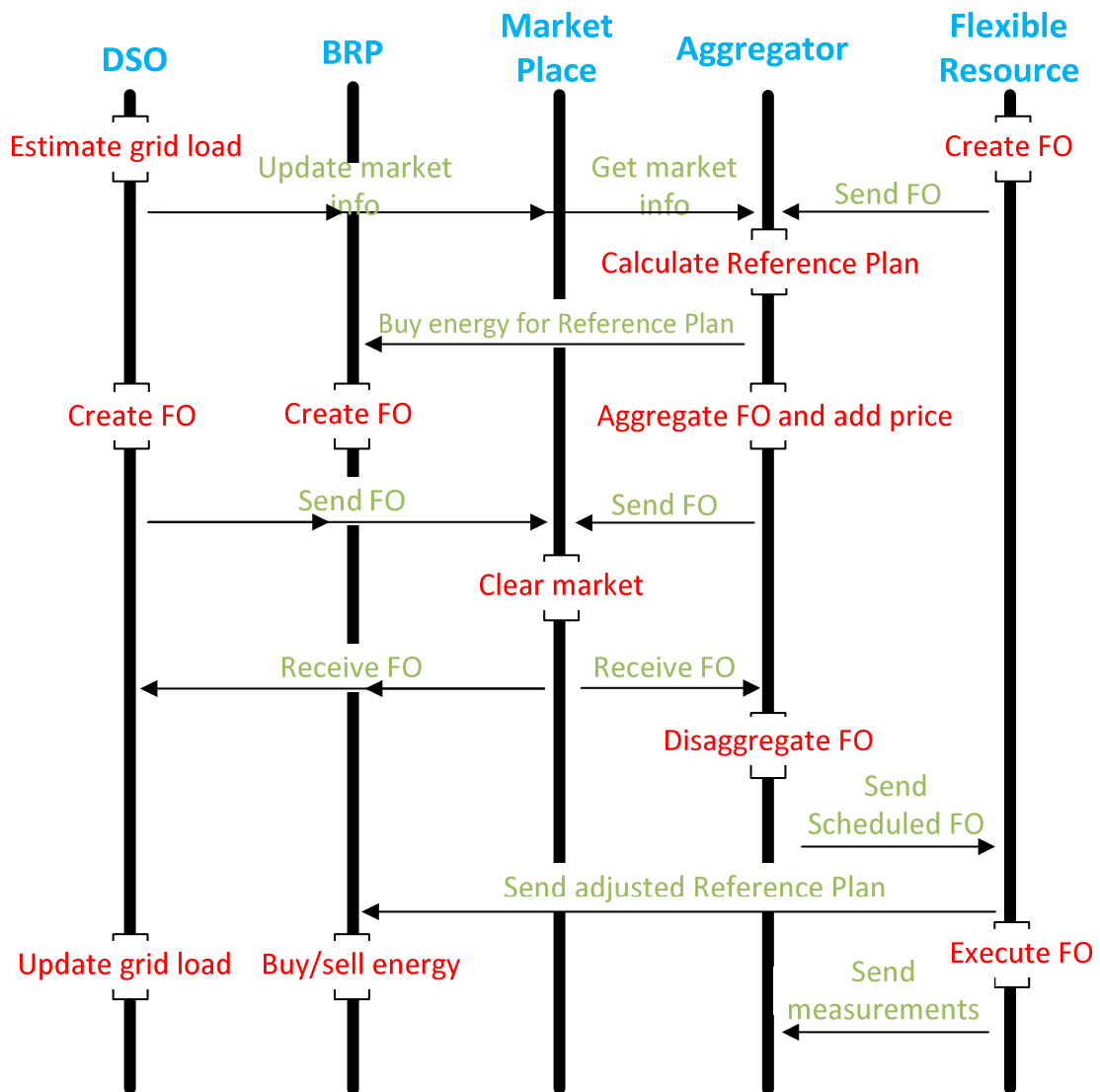

Figure 2: TotalFlex activities day-ahead

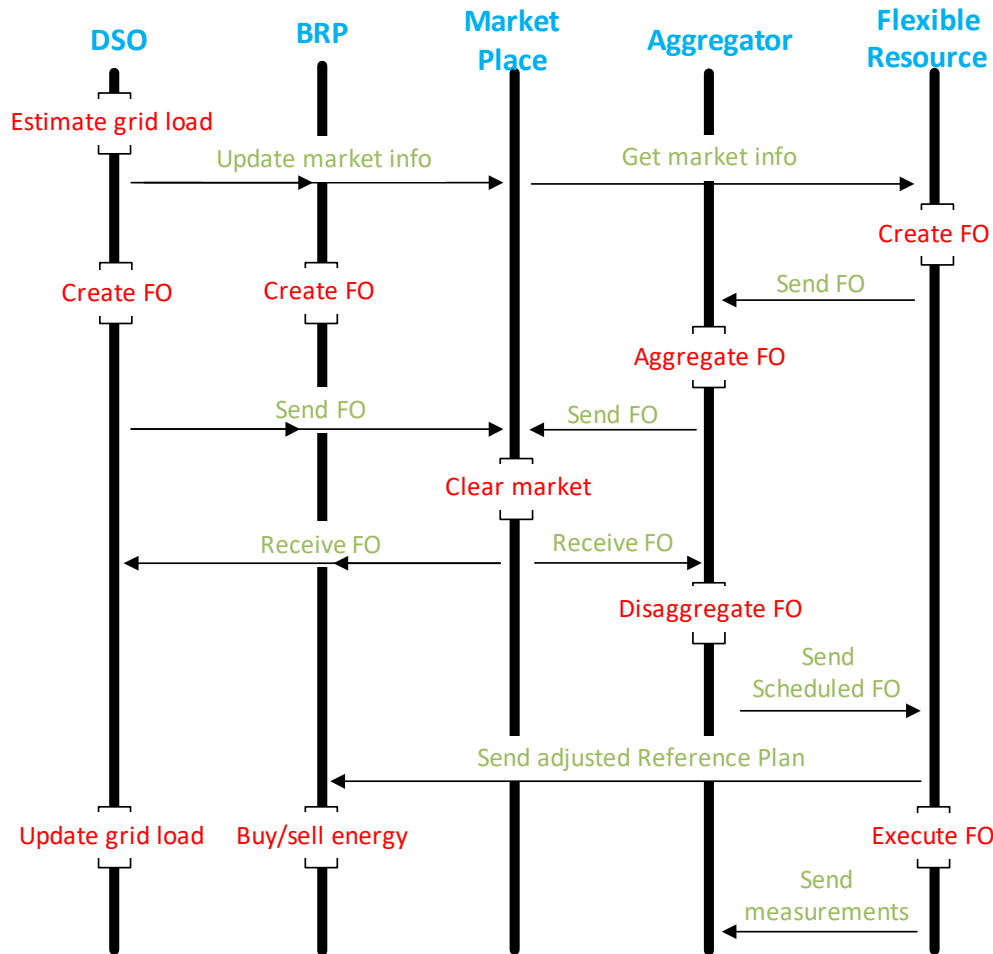

Figure 3: TotalFlex activities intra-day

The implemented *day-ahead activities* are implemented so they fit to the requirements for the Nordpool spot price market. The Flex-Offers here are multi timeslots to cover all the hours of the coming day. Flex-offers sold on the Market Place will issue an adjustment to the reference plan belonging to a Flex-Offer. The activities on the Market Place take place before the final bid is send to the spot price market. This means that all activities on the Market Place will be covered in the final plan for the spot price market and thus generate no imbalance.

The implemented *intra-day activities* are intra-hour, i.e. they take place hourly. It is implemented so it fits to the Nordpool regulating power market. Most of the activities intra-day are similar to the activities day-ahead. However, the Flex-Offers are more simple as “only” one timeslot is covered. Again, selling Flex-Offers from the Aggregator and buying Flex-Offers from DSO and BRP are now made and sent to the Market Place for clearing. A special case is here that purchase from a BRP might be part of operations on the regulating power market and thus not result in any imbalance. This is opposite purchase from a DSO intra-hour.

So the intra-day activities coexist with the day-ahead activities and the flexibility left from day-ahead is used intra-day. After market clearing the scheduled Flex-Offers are disaggregated and operation plans are sent to the Flexible Resources. Depending on the setup and requirements relevant measurements are logged for documentation and settlement.

10.3 Clearing the Market Place

The clearing of Market Place is done mathematically. The key characteristics for the clearing of the Market Place are:

- Mixed Integer Linear Programming (MILP) formulation
- Principle method used is maximizing the society surplus
- Lowest active buying price \geq highest active selling price
- Divisible goods⁹ principle apply for the energy traded here
- Sealed¹⁰ Flex-Offers are applied
- Fixed price per unit from each buyer and seller per timeslot
- Constraints with max/min activated quantity across timeslots for each seller and buyer
- Geographical constraints for a buyer or seller can be applied
- BRP constraints for a buyer or seller can be applied
- A supplier or a buyer can sell or buy only in one direction per timeslot (upwards or downwards)

The clearing means that those buyers who will pay most are scheduled first. Similar those sellers that will sell cheapest are scheduled first. By setting the requirement that society surplus is maximized the profit to the seller is maximized. For simplicity is also assumed that sellers and buyers are willing to sell and buy a fraction of their quantity of interest. By setting up simple constraints various functionality can be added. Two unique types are supported here:

- Geographical constraints for a buyer or seller can be applied, so it fits to i.e. an energy market area like DK1 in Denmark, a low voltage radial etc.
- BRP id constraint for a buyer or seller can be applied, so Flex-Offers belonging to a specific BRP is selected and traded. This will be necessary for a BRP to have interest in the market.

In chapter 9 more in-depth information about the Market Place design is available.

Mathematically the market clearing with N timeslots and K buyers and J sellers can be described like:

min

$$\sum_{i=1}^N \sum_{k=1}^K p_k^b |q_{i,k}^b| - \sum_{i=1}^N \sum_{j=1}^J p_j^s |q_{i,j}^s|$$

subject to

$$\sum_{k=1}^K q_{i,k}^b = \sum_{j=1}^J q_{i,j}^s, \text{ for negative and positive part separately}$$

$$q_{min,i,j,k} \leq q_{i,j,k} \leq q_{max,i,j,k}$$

$$q_{min,i,j,k} \leq 0$$

$$q_{max,i,j,k} \geq 0$$

$$p_{min,i,k} \geq p_{max,i,j}$$

BRP constraints

Geographical area constraints

⁹ Buyer accept that only a fraction of their offered flexibility is scheduled

¹⁰ Seller and buyer do not know anything about the others interest and FOs

$p_{i,k}^b, p_{i,j}^s$ unit price from the k^{th} buyer and j^{th} seller respectively for the activated flexibility for i^{th} timeslot

$q_{i,k}^b, p_{i,j}^s$ buying and selling activated flexibility relative to reference from the k^{th} buyer and j^{th} seller for i^{th} timeslot

An example of 1 time slot market clearing will now be given based on 3 sellers and 2 buyers with the following characteristics:

	Selling Flex-Offers			Buying Flex-Offers	
FO #	1	2	3	1	2
Qup	0	13	13	14	5
Qref	-7	12	-2	0	0
Qdown	-12	-1	-13	-1	-11
Qact		13	-11	13	-11
Punit	8	2	3	10	5
Cost		26	33	65	55
Earning		39	22		
Psettle	5				
Welfare	126				

In the above table quantities are referred to with Q, quantities for increasing and reducing power are noted Qup and Qdown respectively. The reference schedule is denoted Qref and this represent the operation of the Flexible Resource in case nothing is activated. Furthermore, Qup and Qdown are specified relative to Qref. The Punit price represents the minimum selling price per unit for the seller and the maximum buying price for the buyer. After clearing seller FO 2 and most of seller FO 3 are sold. Buyer FO 1 buys 100 % of wanted amount and buyer FO 2 only a fraction. The seller earning is defined as the difference between selling and buying.

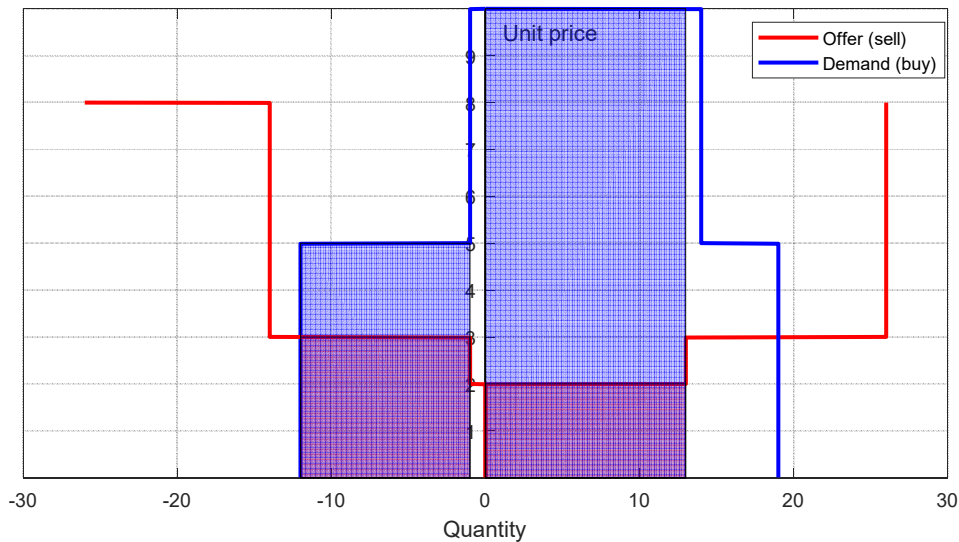

Figure 4: Flex-Offers shown in demand and supply diagram

The above figure shows the Flex-Offers in a *demand and supply* diagram after clearing. The coloured area represents the Flex-Offers that are activated, i.e. bought and sold on the Market Place. The light blue area represents the society welfare which is the seller earning.

Another way of displaying the Flex-Offer prices and settling is shown below:

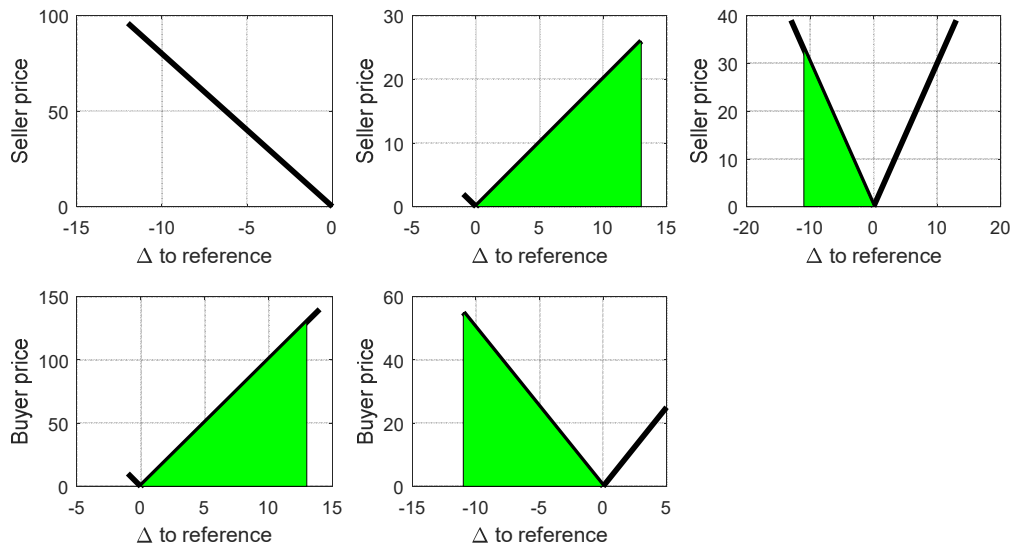

Figure 5: Settled prices of the Flex-Offers

In the above figure the price per activated unit is shown for the 5 Flex-Offers in this example. Prices are strictly proportional to quantity. The green area represents the sold and bought part of the Flex-Offers.

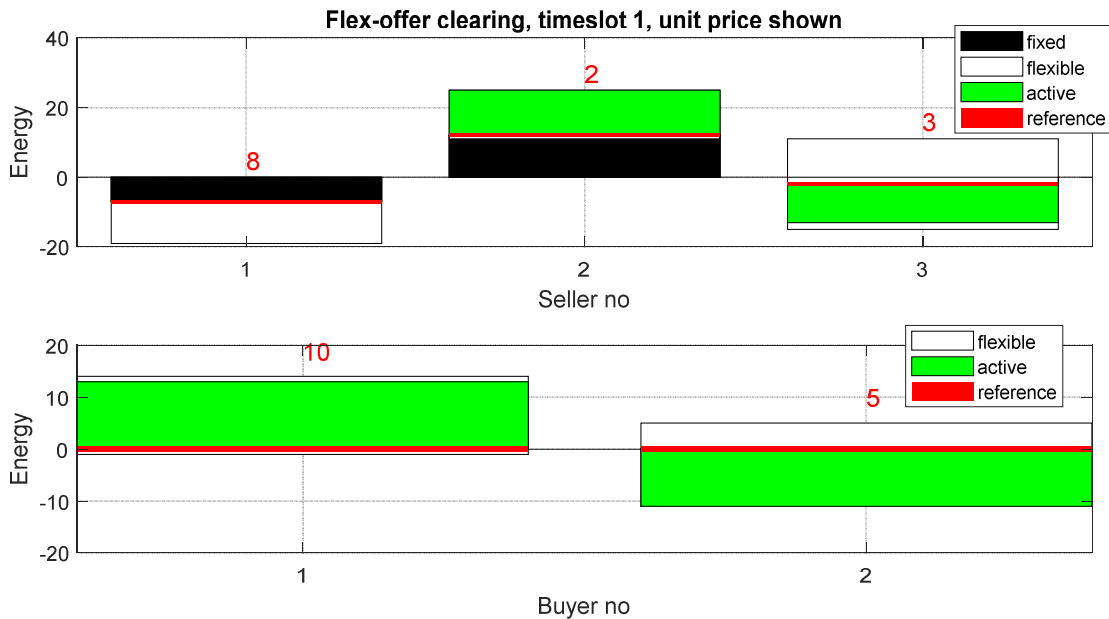

Figure 6: Display of Flex-Offers after settlement

In the above figure the 5 Flex-Offers are shown after settlement. It can be seen that seller FO 1 are not scheduled as the unit price of 8 was too high. Actually, buyer FO 1 is willing to pay 10 per unit, but all its wanted quantity is already delivered by seller 2 and 3.

In many markets like the Nordpool spot price market only one buyer can end up buying the good. This is the same in the TotalFlex Market Place. However, more buyers can still have the benefit of one activated selling bid. A typical example where the BRP wants to buy upwards regulation and gets activated. However, this Flex-Offer activation might also help the DSO reducing its bottleneck. When settling the market *all buyers who have issued a Flex-Offer and benefit of an activat-*

ed Flex-Offer should pay for it. Those who didn't win the bid but benefit should pay their bid price.

The intraday TotalFlex Market Place offers the owner of the Flexible Resource an extra opportunity to earn money on its flexibility, as the DSO now also has a possibility to buy the flexibility. This is compared to existing solutions today where an Aggregator has an agreement with a BRP only regarding exploitations of the flexibility.

10.4 Contract and settlement

A very important part of TotalFlex Market is putting a price on the Flex-Offers and setting up a contract between the involved actors. This will be explained in the following.

10.4.1 House owner

The House owner's motivation to assign to TotalFlex is mainly to reduce cost on energy but supporting the green transition might also be relevant. It is important that it is simple to connect and maintain and there should not be any loss of comfort.

There might be some cost involved in being connected, i.e. setting up a control and data acquisition path to the device. Separate sub metering might also be required. This is very much dependent on how *Smart Grid Ready* the specific Flexible Resource is. The following list the steps involved for a house owner to be connected and deliver services to the TotalFlex Market Place.

- Gateway to secure a control and data logging path to the Flexible Resource
- Sub meter to separate the flexible electricity part with the non-flexible
- Agreement regarding comfort
 - Normal range: temperature span, charging level etc.
 - Extreme range: special circumstances, limited occurrences per year
- Documentation of operation
- Agreement regarding what if external operation is disconnected
- Settlement based on a fixed reward or based on actual deliverables

The simpler the following steps can be established the more likely it is that the house owner will join the Market Place. Agreeing on comfort settings is very much essential regarding contract agreement. The more acceptance of larger comfort limits the more flexibility.

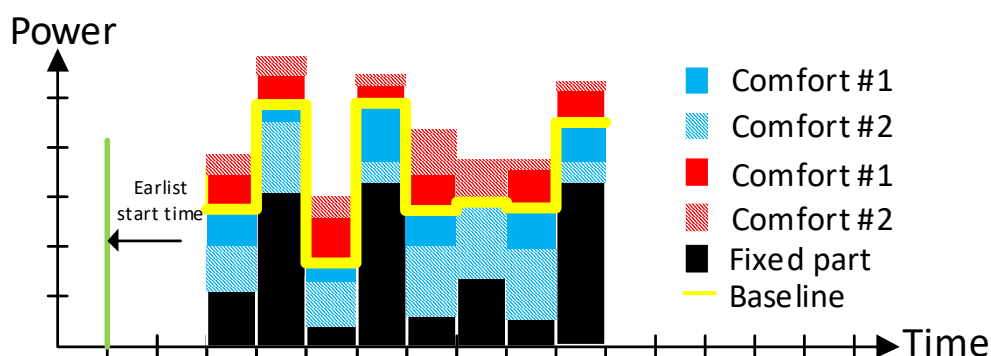

Figure 7: Flexibility as a function of comfort level

In the above figure is shown a typical Flex-Offers with time slices. The black part is the minimum accepted power consumption in order to deliver minimum comfort. The yellow line represents the baseline, i.e. the operation which will take place if no Flex-Offer is accepted. The blue and red part are then the negative and positive flexibility or deviation from baseline. The scratched and the solid filled represents then the two levels of comfort that is available.

10.4.2 Aggregator

The Aggregator fulfills many functions like:

- Connect the Flexible Resources
- Make an agreement with the house owner and setting up a contract
- Aggregate the flexibility into relevant macro Flex-Offers
- Putting a price on the Flex-Offers and send them to the Market Place
- Secure energy to the Flexible Resource
- Operate the Flexible Resource according to the schedule
- Handle imbalance and document operation to buyers of flexibility (i.e. DSO and BRP)
- Secure settlement with house owner

When putting a price on the Flex-Offers the Aggregator consider the following:

- Amount of flexibility
- Calculated potential imbalance cost if being activated
- Reward to House Owner for being activated and participation
- Aggregator's own operation cost and profit margin

10.4.3 BRP

A BRP has a pool of consumption and/or production where it is balance responsible. In TotalFlex the BRP has two roles:

- Balance responsible role for the Aggregator's pool
- Buyer of flexibility

A pool of Flexible Resources is attractive for the BRP as it is controllable and adjustable. This should make a balancing contract between aggregator and BRP cheap. However, from time to time intraday, DSO buys some flexibility and this might create an imbalance cost. A way to handle this has also to be included in the contract.

The BRP is interested in the flexibility for its access to markets with time-varying prices and to reduce internal imbalances. It is also beneficial for the BRP to access aggregated flexibility via a simple interface instead of controlling the individual devices directly. The disadvantage for the BRP is that access to flexibility is not secured, the offered price has to be above the minimum selling price and a buying offer from another buyer. A prerequisite for the BRP is that the flexibility belongs to its balancing pool. This is controlled on the Market Place via a constraint added to the Flex-Offer.

The BRP's price on the Flex-Offer in order to make it profitable for an investment must reflect the expected prices on the energy markets and a coming imbalance cost.

10.4.4 DSO

The DSO has a geographical restricted grid to service. Here buying flexibility might reduce bottle necks and thus postpone expensive strengthening of the grid. The DSO needs to consider if this challenge is acute, future or daily challenge. This decides which market is the best to exercise. If the DSO has a critical situation if it is not activated a long term bilateral agreement is probably the best. Otherwise the DSO should see acting on the Market Place as a way to increase its margin of security of supply.

The offered price for the DSO should always be compared to the alternative, i.e. strengthening the grid.

10.4.5 Market Place

The Market Place is not necessarily a separate legal entity. It is an IT tool which performs a functionality on predefined schedule. A typical setup might be that an IT service provider secure the operation for a fee between the users. The provider might then operate more markets and thus reduce its cost per market.

10.5 GUI

A Graphical User Interface, GUI is developed and demonstrated live in TotalFlex and its key content is explained in this section.

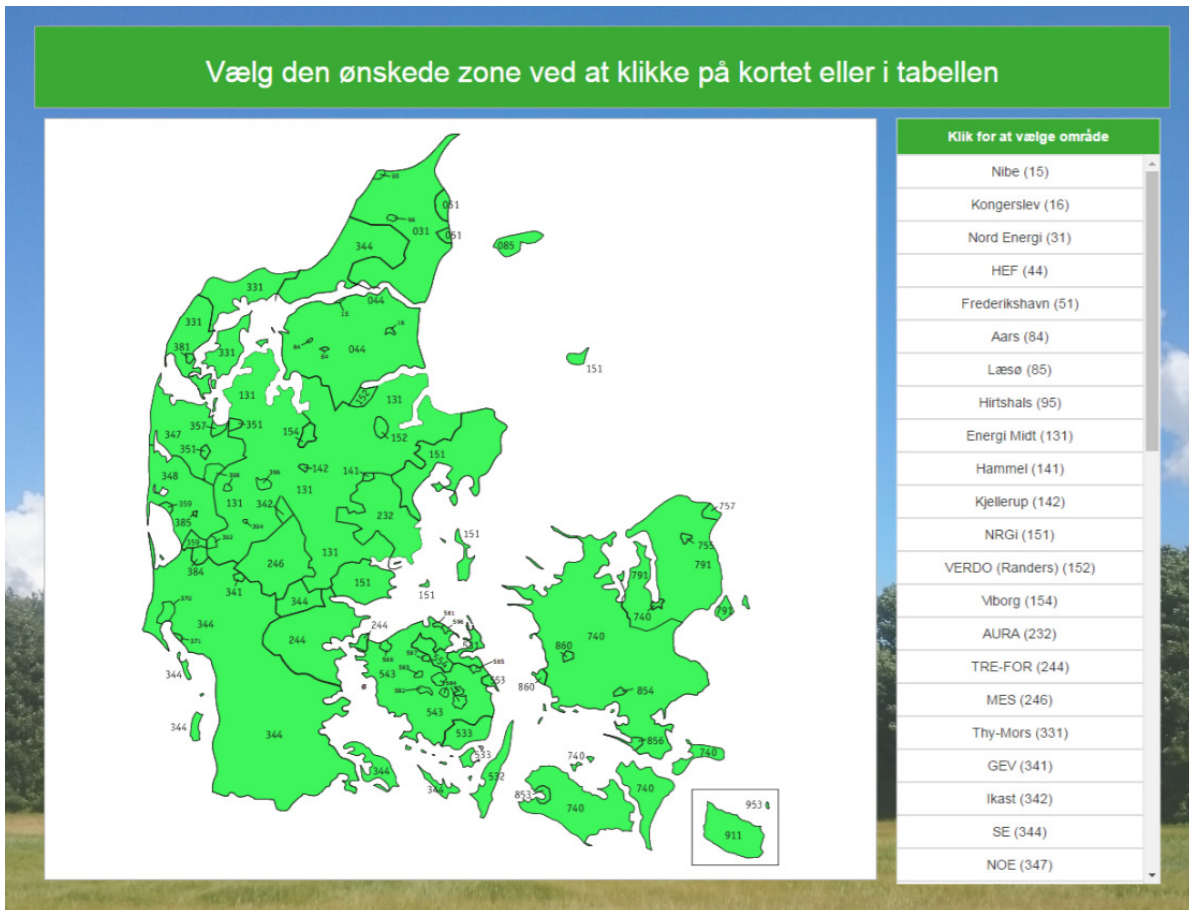

Figure 8: Geographical overview in the GUI

The first GUI page is a DSO overview of Denmark. The idea is to have a capability to drill down and see which geographical area a Flex-Offer belongs to.



Figure 9: Geographical overview in the GUI

The above GUI page gives a geographical representation of the Flex-Offers with price and quantity details in top and clearing data in the lower part, where the scheduled amount per Flex-Offer is shown.

10.6 Demonstration setup

The following actors we involved in the demonstration:

Live prosumers

- Heat pumps in individual houses using the developed heat dial app
- Pool of aggregated heat pumps

DSO

- Low Voltage grid from Støvring area with artificially added wind power and EV to demonstrate bottle neck issues

BRP

- BRP connected to Nord Pool spot price and regulating power market

Aggregator

- Developed Neogrid Aggregator for aggregating and disaggregating Flex-Offers
- Developed AAU Aggregator for hierarchical aggregating and disaggregating of Flex-Offers

Market Place

- Using developed Market Place GUI and the mathematics for market clearing developed by CBS and Neogrid

The process flow of the live demo on an online Market Place clearing is:

- Sensor data being collected
- Neogrid Aggregator generates optimised plan and Flex-Offer per individual house and for each installation
- AAU Aggregator receives the Flex-Offers, optimises, put a price on and sends them to the Market Place
- Generate live buying Flex-Offers from DSO and BRP and put them on the Market Place
- Market clearing on request
- Scheduled Flex-Offers are returned to AAU Aggregator for disaggregation and submission to Neogrid Aggregator
- Neogrid Aggregator dos the final disaggregation and operating plans are sent to the heat pumps

11 WP9 – Standardisation

11.1 Workpackage objectives

The initial objective of this work package was to influence and follow relevant standardisation work and secure that the design and realisation in TotalFlex is done according to relevant standards. This work package is mainly a coordination activity with the purpose of securing a two-way link between relevant standards and TotalFlex. This should secure that relevant standards were followed but also that TotalFlex would influence relevant standards and initiatives/projects with respect to findings from executing the TotalFlex project.

In the application process of the project, a number of focus areas were pointed out from the beginning to be relevant:

1. The initial Flex-offer concept developed from the MIRABEL project, which at that time were on the focus list in CEN/CENELEC CWA
2. Existing focus from system point of view, where IEC 61850-7-420 have been in focus for controlling distributed energy resources (DER) like heat pumps, electrical vehicle etc.
3. Initial focus on IEC 61970, Energy Management System Interface for communication between CVPP, TVPP, DSO and BRP
4. TotalFlex should follow the IEC 62351 standard regarding security.

In item 1) Aalborg University already participated, and in relation to support the standardization work, Flex-Offers a demonstration projects like TotalFlex was needed. Information models described in Item 2) have been the focus for previous ForskEL projects like IFIV¹¹ and READY¹² and therefore it was important to continue this focus in TotalFlex. Security have been a focusarea within the project, but at the current state security concepts for other areas have been investigated and applied.

The above is summed up to the following activities which have been in focus for this work package, which mainly have been a coordination task between projects and the Danish DS/S-557 group with focus on securing information exchange.

1. Secure TotalFlex follows relevant standards for DER communication and communication between Energy Management Systems
2. Support on going standardization work for Flex-Offers
3. Secure TotalFlex can be used as reference platform to maximize standardization influence

This being said, after working with the main high level use cases for TotalFlex, it very fast became clear, that Flex-Offers required a lot more 'marketing' activities in order to tell the story about the benefits of using the Flex-Offer concept. Furthermore, the aggregator role and activities was at the beginning of the project not well defined and accepted in the Danish power system context, which also required allot more work than anticipated in the beginning of the project. Therefore, the objective of the this work package changed over time to more focus on participating and contributing in relevant fora's and initiatives where the regulatory framework for the future power system in Denmark were discussed.

¹¹ ForskEL IFIV, Individuel Fjernstyring af Individuelle Varmepumper (2010-2012)

¹² ForskEL READY, Smart Grid Ready VPP Controller for Heat Pumps (2012-2014)

11.2 Results and disseminations of results

11.2.1 Standardisation activities

In order to fulfil the standardisation focus for the TotalFlex project, Neogrid have been participating in the national coordination group under 'Dansk Standard' DS/S-557 where activities around 'Styring af kraftsystemer og kommunikation' is coordinated. This covers among other, the focus of IEC TC57 related work. However, a large number of other groups and standardization organizations are contributing to this. To try to narrow in the focus areas, the picture in Figure 1 is showing the area of interest. The right side captures the building including the appliances, home automation and heat pump, with related standards. The electrical vehicle is left out of this, as this with respect to standardization is not part of the building, but will be 'connected' directly to the power system. The left side of the figure are showing the power system with related standards. If the power system would like to interact with house appliances, it has to go through a systems interface or Smart Grid Connection Point.

*Left side of the interface is covered by IEC TC57¹³
WG17¹⁴+WG21¹⁵*

*Right side of the interface is covered by CLC
TC205 WG18, IEC TC59¹⁶ WG15¹⁷*

Figure 1: Standardization picture showing interface and standards between building and power system

With respect to the overview in Figure 1, there are mainly two strategies for adding Flex-Offers into the equation. Either the Flex-Offer logic could be added to the system interface covering all appliances in the building or there could be a gateway for a specific group of devices or one proprietary gateway for a specific device adding Flex-Offer logic to a specific device. For simplicity, TotalFlex have chosen the latter.

Based on the Initial work on flex offers from the MIRABEL project, the concept has been submitted to the Smart Grid Steering board, which also is the status at the end of the TotalFlex project.

The idea then was to find out how Flex-Offer information could be mapped into some of the existing standards. However, it became clear that with the present maturity of flex offers, it would not be effective to focus on communication standards. As explained earlier, it was decided that the

¹³ TC 57 – Power systems management and associated information exchange,

¹⁴ TC 57, WG 17 – Communications Systems for Distributed Energy Resources (DER)

¹⁵ TC 57, WG 21 – Interfaces and protocol profiles relevant to systems connected to the electrical grid

¹⁶ TC 59 – Performance of household and similar electrical appliances

¹⁷ TC 59, WG15 – Connection of household appliances to smart grids and appliances interaction

project would benefit more, if remaining focus were put on the aggregator role in general, and on the regulatory framework and procedures required for releasing flexibility and enabling the aggregator role in the power system.

Ongoing standardisation participation have been carried out throughout the project period.

11.2.2 Market Model 2.0

One of the dissemination activities with in this project have been to participate in, and contribute to the Market Model 2.0 project and subsequent activities. Here we participated in the working group 3 regarding promoting the overall business case for demand response.

The result of this work were a number of proposals for:

- Markets
- Potentials for Demand Response
- Barriers
- Solutions and implementation

Our main contribution were in the area of identify barriers for having aggregators entering the market and proposals for how this can be done in the context of the Danish energy system.

11.2.3 EvolvDSO

By participating in the TotalFlex project, we have been invited as advisory board for the european DSO project, EvolvDSO, where we provided input to Phase 1.

evolvDSO (“Development of methodologies and tools for new and evolving DSO roles for efficient DRES integration in distribution networks”) is a FP7 collaborative project funded by the European Commission. The project lasts 40 months (September 2013- December 2016) and is carried out by a Consortium of 16 partners coordinated by Enel Distribuzione.¹⁸

evolvDSO aims to deliver the following main outcomes:

1. Future scenarios and new DSO roles
2. Development of validated tools and methods
3. Evaluation of tools performance
4. Recommendations
5. Roadmap

11.3 Conclusions and future focus

The initial aim for this work package was mainly a coordination task, to secure that TotalFlex were on the right track with respect to following and influencing the right standards for the power system and furthermore to support specific flexoffer standardization work together with Aalborg University.

During the project, the focus were adjusted to focusing on roles and regulations for introducing the aggregator actor into the Danish power system as well. This mainly has been achieved by participating in the MM2.0 activities at Energinet.dk, where the knowledge build up in e.g. TotalFlex were put into play with respect to future market improvements for introducing Demand Response.

Looking ahead, an introduction of the Flex-Offer universe into the Danish power system will have to be done in small steps, to avoid revolutionize the existing system. It is the view of the project

¹⁸ <http://www.evolvdsso.eu/Home/About>

consortium, that huge benefits can be achieved by introducing this technology on several levels. In order to start, Flex-Offers could be used between one aggregator and the prosumers connected to him, solving a specific challenge. When interfacing to existing protocols or systems, Flex-Offers should be translated via 'software bridges' that can connect the two universes so they can co-exist. Future work should further address this topic of how the Flex-Offer universe should co-exist with existing protocols and systems. When Flex-Offers gradually is accepted, the Flex-Offer universe can slowly expand to other systems.

12 Dissemination

A significant dissemination has taken place and is still ongoing within TotalFlex. The major parts of the dissemination will be explained in the following.

12.1 PhDs and Postdocs

The WPs with extensive research content,

- WP1 – Communication infrastructure for metering and control
- WP2 – Intelligent detection and prediction
- WP3 – Data Aggregation and Analysis
- WP4 – User involvement within demand response
- WP5 – Development of a grid load model and Technical VPP (TVPP)
- WP7 – Design and development of a market place

all have postdocs and PhD students allocated. Here significant dissemination took place in the form of articles, conference papers, posters etc. A reference list with articles are given in the end of the chapters covering the above WPs. All papers are available on request and attached as appendix to this report.

12.2 TotalFlex events

TotalFlex has held three demonstration events where most of the developed functionalities inside TotalFlex have been demonstrated.

- TotalFlex demonstrations together with Cities¹⁹: September 9th 2015 at DTU
- TotalFlex demonstrations at Novi
- TotalFlex demonstrations at Energinet

The interest from the Cities project is explained in the cooperation section below.

12.3 Seminars and workshops

TotalFlex has held a lot of internal and external workshops and seminars in order to discuss and further develop the key technology within the project. A major contribution has been using the ideas and findings from TotalFlex within the “Market model 2.0” work at Energinet, which has been ongoing the last years. Neogrid Technologies and AAU have both been involved in the work.

12.4 Cooperation with other projects

TotalFlex has been cooperating with many other projects as there has been a significant interest in the Flex-Offer concept and the idea with a market place where flexibility can be bought from any buyer who are willing to pay the highest price. Two bigger cooperation has taken place with Cities and Arrowhead²⁰ and will be clarified in the following:

12.4.1 Cities

The Cities project is a Smart City project where heating systems for a whole city and country level is analysed. This is not only regarding energy supplied from electricity but from all sources.

¹⁹ Centre for **IT-Intelligent Energy System** in Cities, <http://smart-cities-centre.org/> supported by the Danish Council for Strategic Research.

²⁰ Collaborative automation by networked embedded devices, <http://www.arrowhead.eu/> a project under Artemis EU fp7 program

Analysis has been done where Flex-Offer is used to represent the flexibility within operation of greenhouses supplied by district heating. Thereby an aggregated load profile from a district with greenhouses is put into a Flex-Offer together with prices. This is now presented to the district heating company as an option. Maybe the district heating company can reduce its operating cost by shifting some consumption away from expensive hours. Even if it costs some money to the greenhouses involved it might be a good idea.

The cooperation project has shown that Flex-Offers is a useful concept for describing flexibility of many kinds and any origin and that the simplest Market Place with one buyer and seller is operational.

12.4.2 Arrowhead

Arrowhead is a big EU project promoting an IoT framework where AAU and Neogrid among more than 60 parties are participating. As a demonstration case a *Virtual Market of Energy* has been demonstrated. The demonstration with the IoT framework is a good practical example on how various devices without any human interaction easily can connect and communicate. Compared to the demonstration inside TotalFlex the demonstration in Arrowhead had a larger scope with these new parts connected:

- Energy management inside industry buildings
- Operation of elevators with battery backup
- Charging of EVs
- Low Voltage grid challenges in an area of Stavanger equipped with many EVs
- Operation of freezers
- Operation of water heaters

In this demonstration, again Flex-Offers and the Market Place have played an important role. The demonstration of the Virtual Market of Energy shows how various types of Flexible Resources can deliver flexibility and in a simple way connect to an Aggregator and then a Market Place via the proposed Arrowhead XMPP²¹ framework. The demonstration also showed the effectiveness of the developed aggregation and disaggregation techniques.

A summary of the demonstration and its finding is documented in a separate chapter in the *Arrowhead Book*²².

²¹ Extensible Messaging and Presence Protocol (XMPP) is a communications protocol well suited for IoT devices

²² http://www.arrowhead.eu/wp-content/uploads/2017/02/K27545_IoT_Automation.pdf

13 Conclusion

TotalFlex is a big project. It is very much research oriented and has been ongoing for nearly 5 years. The goal of TotalFlex has been to develop and demonstrate a new market place for any size of flexibility, open for any party and securing the seller an optimum price. This is very much achieved.

The two main achievements are:

- A Flex-Offer concept to characterize flexibility in a generic way and make it operational
- A demonstrated Market Place for Flex-Offer

With the Flex-Offer concept a generic concept of describing and operating on any size of flexibility is established. Black box methods have been developed to estimate the existence amount of flexibility based on available smart meter data. It has been demonstrated how Flexible Resources can be connected and controlled via a gateway in the house or directly. The work is Market model 2.0 compliant where the Flexible Resources are separated and settled separately from the traditional consumption and production.

A lot of work and developments have been done on the Flex-Offer operation regarding aggregation, disaggregation and storage techniques. Thereby it is realistic to aggregate millions of flexibility parts to the wanted size. The Flex-Offer concept has also shown to be an attractive way of comparing to Flexible Resources with regarding to offer flexibility. The Flex-Offer concept has been extended to include a price on the Flex-Offer, so it can be directly used on the Market Place. An IT tool "Commercial VPP", CVPP has been developed to support the Aggregator operations on Flex-Offers.

Another area of high focus is the DSO, where future challenges due to the "green transition" and more electricity consumption in general have been analysed. An IT tool "Technical VPP", TVPP which estimates grid load based on available meter data and a few extra measurement points has been developed. This forms the basis for the DSO's interest in buying flexibility and what price to offer.

The BRP secures the connection to the existing energy markets. The BRP role in TotalFlex is two-fold, first the BRP has an interest in buying flexibility for low prices on the markets and to reduce own imbalance, second the BRP might also have a balancing role for the Aggregator. A way to handle this has been made is presented in the project.

A Market Place for direct control of flexibility has been demonstrated. The Market Place is not *selling* energy but the right to *schedule* it. The Market Place can operate in more time dimensions simultaneously, i.e. long term, day-ahead and intra-day. Algorithms for market clearing have been demonstrated. Sequence diagrams have shown how the Market Place coexist and work as add-on to existing markets. With the TotalFlex Market Place new possibilities for Prosumers to deliver and profit on their flexibility is presented. Also, the Market Place presents a way where DSO's can use flexibility to mitigate their bottleneck challenges.

Right now, there is a lot of interest in the Flex-Offer concept and the idea of Market Place and it is being further developed and used within the work inside *Intelligent Energy*²³ and in coming research projects.

²³ <http://www.ienergi.dk/forside>, interest group under Dansk Energi, <https://www.danskenergi.dk/>